

Register your instrument!  
[www.eppendorf.com/myeppendorf](http://www.eppendorf.com/myeppendorf)



## Multipipette® M4 · Repeater® M4

**Operating manual**

Copyright© 2016 Eppendorf AG, Germany. All rights reserved, including graphics and images. No part of this publication may be reproduced without the prior permission of the copyright owner.

Eppendorf® and the Eppendorf logo are registered trademarks of Eppendorf AG, Germany.

Multipette®, Repeater®, Combitips advanced® and Biopur® are registered trademarks of Eppendorf AG, Germany.

Registered trademarks and protected trademarks are not marked in all cases with ® or ™ in this manual.

Protected by U.S. Patent Nos. 5,573,729; 5,591,408; 8,114,361

U.S. Design Patents are listed on [www.eppendorf.com/ip](http://www.eppendorf.com/ip)

## Table of contents

<b>1</b>	<b>Operating instructions</b>	<b>6</b>
1.1	Using this manual	6
1.2	Danger symbols and danger levels	6
1.2.1	Danger symbols	6
1.2.2	Danger levels	6
1.3	Symbols used	7
1.4	Glossary	7
<b>2</b>	<b>Safety</b>	<b>12</b>
2.1	Intended use	12
2.2	Warnings for intended use	12
2.3	Information on product liability	14
<b>3</b>	<b>Product description</b>	<b>15</b>
3.1	Main illustration	15
3.2	Display	16
3.3	Features	17
3.4	Combitip advanced	18
3.5	Overview of Combitips advanced with color codes	19
3.6	Delivery package	20
3.7	Materials	20
3.8	Warranty	21
<b>4</b>	<b>Installation</b>	<b>22</b>
4.1	Using the holder	22
4.1.1	Mounting the holder on a wall	22
4.1.2	Inserting the holder into the pipette carousel	23

## Table of contents

4 Multipette® M4 · Repeater® M4  
English (EN)

<b>5</b>	<b>Operation</b>	<b>24</b>
5.1	Inserting the Combitip advanced	24
5.1.1	Selecting the Combitip advanced	25
5.1.2	Unpacking the Combitip advanced	26
5.1.3	Assembling the Combitip advanced and Adapter advanced	26
5.1.4	Inserting the Combitip	28
5.1.5	Picking up Combitips out of the rack	29
5.2	Setting the volume	30
5.2.1	Setting the volume before dispensing	30
5.3	Using the step counter	31
5.3.1	Step counter display for Combitip filled to capacity	31
5.3.2	Sequential step counter display for a Combitip that has been filled to capacity several times	32
5.3.3	Resetting the step counter to Zero when Combitip is filled repeatedly	33
5.3.4	Step counter display if Combitip is partially filled	33
5.4	Aspirating liquid	34
5.5	Dispensing liquid	35
5.5.1	Discarding the reverse stroke	35
5.5.2	Dispensing liquid	36
5.6	Ejecting the Combitip advanced	37
5.6.1	Combitip advanced 25 mL and 50 mL	38
5.7	Dispensing with an empty battery	38
<b>6</b>	<b>Troubleshooting</b>	<b>39</b>
6.1	General errors	39
6.1.1	Battery	39
6.1.2	Combitip advanced	39
6.1.3	Display	40
6.1.4	Error codes	41
6.1.5	Aspirating liquid	42
6.1.6	Measurement errors	43

<b>7</b>	<b>Maintenance</b> .....	<b>44</b>
7.1	Cleaning .....	44
7.2	Replacing the battery .....	45
7.3	Decontamination before shipment .....	46
<b>8</b>	<b>Technical data</b> .....	<b>47</b>
8.1	Measurement errors .....	47
8.2	Ambient conditions .....	49
<b>9</b>	<b>Transport, storage and disposal</b> .....	<b>50</b>
9.1	Transport .....	50
9.2	Storage .....	50
9.3	Disposal .....	51
<b>10</b>	<b>Ordering Information</b> .....	<b>52</b>
10.1	Combitips advanced .....	54
10.2	Accessories .....	57
	<b>Index</b> .....	<b>58</b>

# 1 Operating instructions





## 1.1 Using this manual

- ▶ Read this operating manual completely before using the device for the first time. Please also note the operating instructions for the accessories, if applicable.
- ▶ The instructions for use for the Combitips advanced can be found on our webpage [www.eppendorf.com/cbt](http://www.eppendorf.com/cbt).
- ▶ This operating manual is part of the product. Please keep it in a place that is easily accessible.
- ▶ Enclose this operating manual when transferring the device to third parties.

## 1.2 Danger symbols and danger levels

The safety precautions in these instructions have the following danger symbols and danger levels:

### 1.2.1 Danger symbols

	<b>Biohazard</b>		<b>Explosion</b>
	<b>Toxic substances</b>		<b>Hazard point</b>
	<b>Material damage</b>		

### 1.2.2 Danger levels

<b>DANGER</b>	<i>Will</i> lead to severe injuries or death.
<b>WARNING</b>	<i>Can</i> lead to severe injuries or death.
<b>CAUTION</b>	Can lead to light to moderate injuries.
<b>ATTENTION</b>	May lead to material damage.

## 1.3 Symbols used

Symbol	Meaning
▶	Handling
1. 2.	Actions in the specified order
•	List
①	Step in the figures
<i>Text</i>	Name of fields in the software
<b>i</b>	Useful information

## 1.4 Glossary

### A

#### **Adapter advanced**

Connecting piece for the dispenser when using Combitips advanced 25 mL and 50 mL

#### **Additional volume**

The total of the remaining stroke and the reverse stroke.

### B

#### **Biopur**

Eppendorf Biopur® is an Eppendorf AG purity level for consumables. Eppendorf Biopur® meets the requirements for standard products, e.g., precision, accuracy, wetting behavior, tightness. Eppendorf Biopur® also fulfills the requirements with regard to sterility, absence of ATP, PCR inhibitors, human and bacterial DNA, pyrogens, DNase and RNase.

Consumables with the Biopur purity grade are controlled and certified by an external laboratory.

Certificates are available for downloading from our webpage

[www.eppendorf.com](http://www.eppendorf.com).

## C

### **Coding**

The dispenser uses the Combitip coding to detect the Combitip's maximum volume.

### **Color code**

The color code displays the maximum volume.

### **Combitip advanced**

Consumables for all Eppendorf Multipettes and Repeaters. With the Combitip advanced, the dispenser becomes an operational dispenser. Combitips advanced are intended for single use. Combitips advanced consist of a piston and a cylinder and function according to the positive displacement principle. For Combitips advanced with a maximum volume of 25 mL or 50 mL, the Adapter advanced is also required.

## D

### **Dispenser**

A dispenser is a dosing device. The dispenser dispenses the aspirated volume in steps.

### **Dispensing volume**

Volume per dispensing step.

## E

### **Eppendorf Quality**

Eppendorf Quality is an Eppendorf AG purity grade for consumables. Eppendorf Quality meets the requirements for standard products, e.g., precision, accuracy, wetting behavior and tightness.



## F

### **Free jet dispensing**

Dispensing the liquid without the Combitip touching the tube inner wall. If a drip forms on the Combitip after free jet dispensing, this drip always belongs to the next dispensing step. We recommend completing a dispensing series using only the free jet method or wall dispensing method. Complete the reverse stroke in accordance with the dispensing series using either the free jet or wall dispensing method. Errors listed in the technical data were determined using the wall dispensing method.

## G

### **Graduation**

Incremental graduation of a range, a surface or a volume.

## I

### **Increment**

Step size or resolution.

### **ISO 8655**

The ISO 8655 standard defines limiting values for systematic errors [accuracy], random errors [precision]) and the test methods for dispensing devices.

## M

### **Maximum volume**

The maximum volume that can be used for dispensing.

## N

### **Nominal volume**

The maximum dispensing volume of a Combitip in conjunction with the selected dispensing device. The term "nominal volume" comes from the ISO 8655 standard.

**P****PCR clean**

PCR clean is an Eppendorf AG purity grade for consumables. PCR clean meets the requirements for standard products, e.g., precision, accuracy, wetting behavior, tightness. PCR clean also meets the requirements with regard to absence of human DNA, DNase, RNase and PCR inhibitors.

Consumables with the PCR clean purity grade are controlled and certified by an external laboratory.

Certificates are available for downloading from our webpage [www.eppendorf.com](http://www.eppendorf.com).

**Positive displacement principle**

The liquid comes into direct contact with the Combitip piston during aspiration and dispensing. Unlike with a pipette, the liquid and piston are not separated by an air cushion. A small air bubble is visible at the piston during dispensing.

**R****Random error**

Precision. Standard deviation of the average value of the dispensed volumes.

**Remaining stroke**

Liquid reserve. The liquid which remains after all dispensing steps have been completed. You can discard the liquid of the remaining stroke or reuse it.

**Residual stroke lock**

The residual stroke lock prevents that the incorrect volume is being dispensed if there is not enough liquid available for the dispensing volume.

**Reverse stroke**

After aspiration, the piston is moved into a defined position. Liquid is dispensed during this piston movement. The reverse stroke is not a dispensing step.

## S

### **Sterile**

Sterile is an Eppendorf AG purity grade for consumables. Sterile meets the requirements for standard products, e.g., precision, accuracy, wetting behavior, tightness. Sterile also meets the requirements with regard to sterility and freedom from pyrogens.

### **Stroke**

A stroke is the distance travelled by the piston.

### **Systematic error**

Accuracy. Deviation of the average value of the dispensed volumes from the selected volume.

## 2 Safety

### 2.1 Intended use

The Multipette M4/Repeater M4 is a lab device and in combination with a Combitip advanced it is intended for dispensing aqueous solutions in the volume range of 1 µL – 10 mL. In vivo applications (applications in or on the human body) are not permitted.

The Multipette M4/Repeater M4 may only be operated by trained specialists. All users must have read the operating manual carefully and familiarized themselves with the device's mode of operation.

### 2.2 Warnings for intended use



#### **WARNING! Damages to health due to infectious liquids and pathogenic germs.**

- ▶ When handling infectious liquids and pathogenic germs, observe the national regulations, the biological security level of your laboratory, the material safety data sheets, and the manufacturer's application notes.
- ▶ Wear personal protective equipment.
- ▶ For comprehensive regulations about handling germs or biological material of the risk group II or higher, please refer to the "Laboratory Biosafety Manual" (source: World Health Organisation, Laboratory Biosafety Manual, in its respectively current valid version).



#### **WARNING! Damage to health due to toxic, radioactive or aggressive chemicals.**

- ▶ Wear personal protective equipment.
- ▶ Observe the national regulations for handling these substances.
- ▶ Observe the material safety data sheets and manufacturer's application notes.



**CAUTION! Danger to individuals due to careless use.**

- ▶ Never point the opening of a Multipette M4/Repeater M4 which is equipped with a Combitip at yourself or other persons.
- ▶ Only initiate dispensing if it is safe to do so.
- ▶ With any dispensing task please ensure that you do not endanger yourself and other persons.



**CAUTION! Poor safety due to incorrect accessories and spare parts.**

The use of accessories and spare parts other than those recommended by Eppendorf may impair the safety, functioning and precision of the device. Eppendorf cannot be held liable or accept any liability for damage resulting from the use of incorrect or non-recommended accessories and spare parts, or from the improper use of such equipment.

- ▶ Only use accessories and original spare parts recommended by Eppendorf.



**NOTICE! Carry-over, contamination and incorrect dispensing results due to the incorrect use of Combitips.**

Combitips are intended for single use. Prolonged use can have a negative impact on dispensing accuracy.

- ▶ Only use Combitips once.
- ▶ Do not use washed and/or autoclaved Combitips for dispensing.



**NOTICE! Damage to the device due to penetration of liquids.**

- ▶ Do not allow any liquids to penetrate the inside of the housing.
- ▶ If liquid has entered the inside of the housing, the inner parts may only be repaired by Eppendorf AG service partners. Contact your local sales office before returning any devices.

## 2.3 Information on product liability

In the following cases, the designated protection of the device may be compromised. Liability for any resulting property damage or personal injury is then transferred to the operator:

- The device is not used in accordance with the operating manual.
- The device is used outside of its intended use.
- The device is used with accessories or consumables which are not recommended by Eppendorf.
- The device is maintained or repaired by people not authorized by Eppendorf.
- The user makes unauthorized changes to the device.

### 3 Product description

#### 3.1 Main illustration

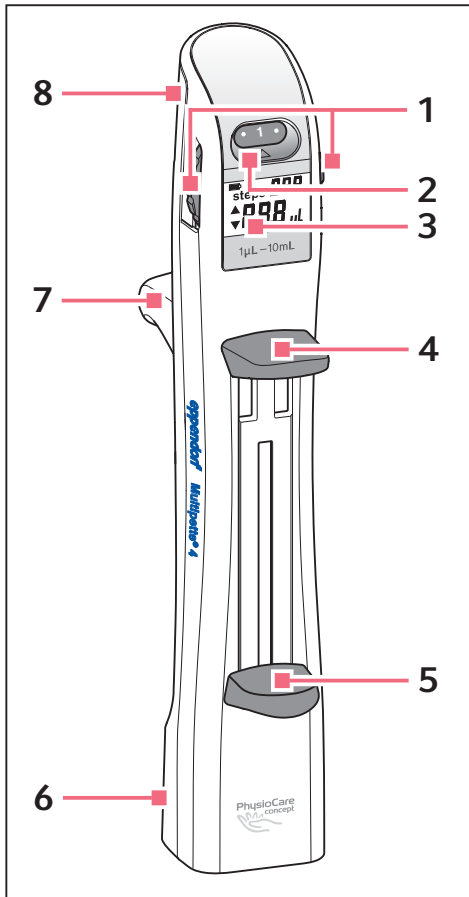

- 1 Volume selection dial
- 2 Position indicator
- 3 Display
- 4 Operating lever
- 5 Filling lever
- 6 Serial number
- 7 Finger rest
- 8 Battery compartment lid

## 3.2 Display

When you insert a Combitip, the display switches on automatically. The display switches off automatically when it has not been used for a period of time (Sleep function). The display automatically switches back on when the Multipette M4/ Repeater M4 is moved. If no Combitip is inserted, the display does not switch back on when moved.



### 1 Number of steps

When selecting the volume, the maximum number of possible dispensing steps are displayed. During dispensing, the dispensing steps that have been carried out are displayed.

### 2 Volume

In  $\mu\text{L}$  or  $\text{mL}$

### 3 Possible direction of the next piston movement

Aspiration ▲ or dispensing ▼

### 4 Battery symbol

Will be displayed briefly after the battery is inserted. If the end of the battery service life approaches, the charging status will be displayed.

- i** If the display flashes, the current or next operating step is not a dispensing step.



### 3.3 Features

The Multipette M4/Repeater M4 dispenser can only be operated with a Combitip advanced. This makes the Multipette M4/Repeater M4 dispenser a positive displacement dispenser. Depending on the Combitip advanced used, you can dispense volumes in the range from 1 µL to 10 mL.

The dispensing volume is set with the volume selection dial and shown on the display. For each Combitip advanced 20 different dispensing volumes can be set with the volume selection dial. Depending on the dispensing volume, 5 to 100 dispensing steps can be carried out with a Combitip advanced that is filled to capacity. The display shows the number of possible or completed dispensing steps. The display of the dispensing volume and the possible dispensing steps is made possible by the automatic detection of the size of the Combitip advanced. Automatic detection is via a coding on the Combitip advanced and a sensor ring in the dispenser Multipette M4/Repeater M4. The electrical supply for the electronics is via a battery.

The reliable detection and the secure seating during dispensing the Combitip advanced in the Multipette M4/Repeater M4 dispenser is ensured by a center sleeve in the Multipette M4/Repeater M4 dispenser.

The Combitip advanced is filled or emptied via the lower filling lever. Dispensing is carried out with the upper operating lever. If the piston in the Combitip advanced is pushed down as far as it will go with the filling lever, the Combitip advanced can be ejected by pushing the operating lever.

The 25 mL or 50 mL Combitip advanced can only be used together with the corresponding Adapter advanced. Combitip advanced and Adapter advanced are assembled before inserting into the Multipette M4/Repeater M4 dispenser. All Combitip advanced and the two Adapter advanced are color coded.

**Product description**

Multipette® M4 · Repeater® M4  
English (EN)

### 3.4 Combitip advanced

Combitips advanced are single-use items for aspirating and dispensing liquids according to the positive displacement principle. Combitips advanced are used in Eppendorf dispensers (e.g., Multipettes/Repeaters) and are made up of a cylinder and a piston. Combitips advanced in sizes 25 mL and 50 mL require an Adapter advanced. Combitips advanced are available in various color-coded sizes.

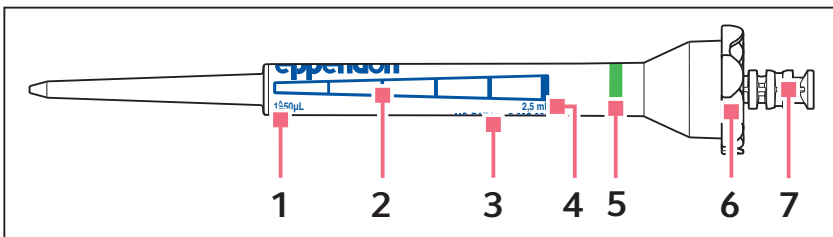

Fig. 3-1: Combitip advanced

- |          |   |          |                   |
|----------|---|----------|-------------------|
| <b>1</b> | <b>Dispensing volume with the manual dispenser at selection dial position 1</b> | <b>5</b> | <b>Color code</b> |
| <b>2</b> | <b>Graduation</b>   | <b>6</b> | <b>Coding</b>     |
| <b>3</b> | <b>US patent numbers</b>  | <b>7</b> | <b>Piston</b>     |
| <b>4</b> | <b>Maximum volume</b>   |          |                   |



**Product description**

Multipette® M4 · Repeater® M4  
English (EN)

### 3.6 Delivery package

Quantity	Description
1	Multipette M4/Repeater M4
1	Operating manual
1	Mini-CD with operating manual and additional information
1	Combitip advanced 2.5 mL
1	Holder for Multipette M4/Repeater M4
1	Battery (fitted)
1	Eppendorf certificate

### 3.7 Materials



**NOTICE! Aggressive substances may damage dispensers, Combitips and accessories.**

- ▶ Check the chemical resistance when using organic solvents or aggressive chemicals.
- ▶ Please note the cleaning instructions.

The parts of the Multipette M4/Repeater M4 that can be accessed by the user are made from the following materials:

Component	Material
Housing parts	Improved polypropylene (PP)
Filling lever, operating lever	Improved polypropylene (PP), dyed
Viewing window	Polycarbonate (PC)
Volume selection dial	Acrylonitrile styrene copolymerisate with polycarbonate (ASA/PC)
Other external components	<ul style="list-style-type: none"> <li>• Polyetherimide (PEI)</li> <li>• Polybutylene terephthalate (PBT)</li> <li>• Polyetheretherketone (PEEK)</li> <li>• Acrylonitrile styrene copolymerisate with polycarbonate (ASA/PC)</li> <li>• Silicone</li> </ul>

<b>Component</b>	<b>Material</b>
Holder	Acrylonitrile styrene copolymerisate with polycarbonate (ASA/PC)
<b>Combitip advanced</b>	
<b>Component</b>	<b>Material</b>
Cylinder	Polypropylene (PP)
Piston 0.1 mL and 0.2 mL	Polyethylene (PE) with glass fiber (GF)
Piston 0.5 mL to 50 mL	Polyethylene (PE)
Adapter advanced	Polybutylene terephthalate (PBT)

### 3.8 Warranty

Please contact your local Eppendorf contractual partner for warranty claims.

No warranty is given in the following cases:

- In the case of misuse.
- If unauthorized persons open the dispenser.

The following assemblies are excluded from the warranty:

- Wear parts
- Battery

## 4 Installation

### 4.1 Using the holder

The accessories include a holder for the Multipette M4/Repeater M4. The holder can be used for wall mounting or as a holder in the pipette carousel.

#### 4.1.1 Mounting the holder on a wall

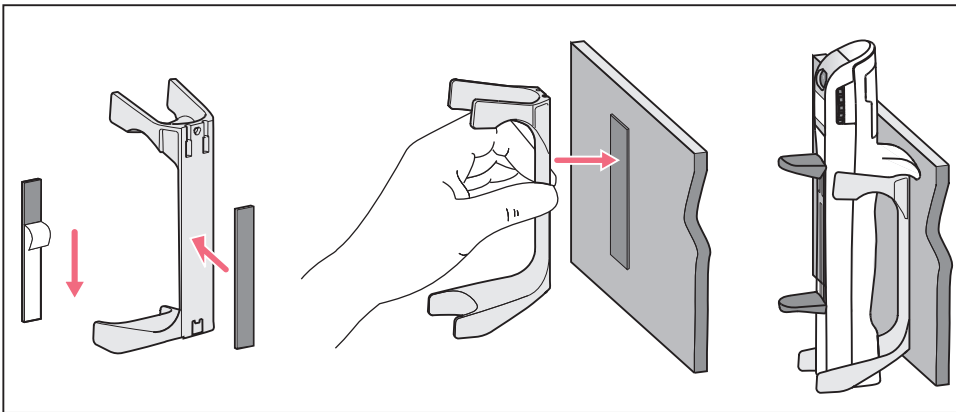

1. Remove the protective film on a hook-and loop tape and stick the hook-and loop tapes to the back of the holder. Press the hook-and-loop tapes down firmly.
2. Clean glass or ceramic surfaces (e.g., with ethanol) and allow them to dry.
3. Remove the protective film on the second hook-and-loop tape and press the hook-and-loop tape firmly against the clean surface. Join the hook-and-loop tape on the Multipette M4 holder to the hoop-and loop tape on the wall. It may only be placed under load after 24 hours.

#### 4.1.2 Inserting the holder into the pipette carousel

You can hang the Multipette M4/Repeater M4 into a pipette carousel. To hang the Multipette M4/Repeater M4 into the pipette carousel, you need to insert the holder. Proceed as follows:

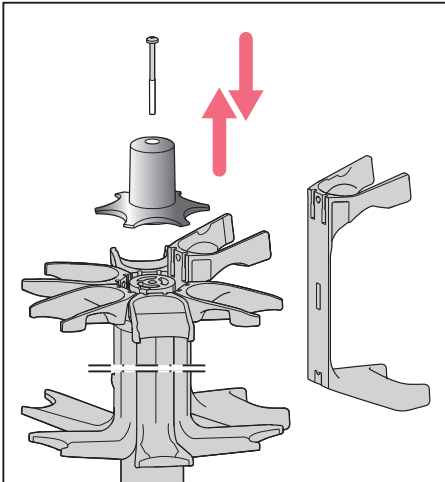

1. Undo the screw at the top end of the pipette carousel and remove it.
2. Remove the cover.
3. Press the pipette holder from below out of the mounting.
4. Push the holder into the recesses in the pipette carousel from above.
5. Close the cover.
6. Tighten the screw.

## 5 Operation

### 5.1 Inserting the Combitip advanced

---



**NOTICE! Carry-over, contamination and incorrect dispensing results due to the incorrect use of Combitips.**

Combitips are intended for single use. Prolonged use can have a negative impact on dispensing accuracy.

- ▶ Only use Combitips once.
- ▶ Do not use washed and/or autoclaved Combitips for dispensing.



**NOTICE! Damage to the device due to incorrect Combitip.**

The dispenser locating is only suitable for Combitips advanced. Other Combitips could damage the locating.









- ▶ Only use Combitips advanced.
-



### 5.1.1 Selecting the Combitip advanced

The Multipette M4/Repeater M4 can only be used with Combitips advanced. With the Multipette M4/Repeater M4 and each Combitip advanced you can select 20 different dispensing volumes.

► Use the volume table to select the corresponding volume and Combitip.

Selec- tion dial	Dis- pens- ing steps	0.1 mL	0.2 mL	0.5 mL	1.0 mL	2.5 mL	5.0 mL	10 mL	25 mL	50 mL
		 white	 light blue	 purple	 yellow	 green	 blue	 orange	 red	 light gray
•	100	1.0 µL	2.0 µL	5.0 µL	10 µL	25 µL	50 µL	0.1 mL	0.25 mL	0.5 mL
1	50	2.0 µL	4.0 µL	10 µL	20 µL	50 µL	100 µL	0.2 mL	0.50 mL	1.0 mL
•	33	3.0 µL	6.0 µL	15 µL	30 µL	75 µL	150 µL	0.3 mL	0.75 mL	1.5 mL
2	25	4.0 µL	8.0 µL	20 µL	40 µL	100 µL	200 µL	0.4 mL	1.00 mL	2.0 mL
•	20	5.0 µL	10 µL	25 µL	50 µL	125 µL	250 µL	0.5 mL	1.25 mL	2.5 mL
3	16	6.0 µL	12 µL	30 µL	60 µL	150 µL	300 µL	0.6 mL	1.50 mL	3.0 mL
•	14	7.0 µL	14 µL	35 µL	70 µL	175 µL	350 µL	0.7 mL	1.75 mL	3.5 mL
4	12	8.0 µL	16 µL	40 µL	80 µL	200 µL	400 µL	0.8 mL	2.00 mL	4.0 mL
•	11	9.0 µL	18 µL	45 µL	90 µL	225 µL	450 µL	0.9 mL	2.25 mL	4.5 mL
5	10	10 µL	20 µL	50 µL	100 µL	250 µL	500 µL	1.0 mL	2.50 mL	5.0 mL
•	9	11 µL	22 µL	55 µL	110 µL	275 µL	550 µL	1.1 mL	2.75 mL	5.5 mL
6	8	12 µL	24 µL	60 µL	120 µL	300 µL	600 µL	1.2 mL	3.00 mL	6.0 mL
•	7	13 µL	26 µL	65 µL	130 µL	325 µL	650 µL	1.3 mL	3.25 mL	6.5 mL
7	7	14 µL	28 µL	70 µL	140 µL	350 µL	700 µL	1.4 mL	3.50 mL	7.0 mL
•	6	15 µL	30 µL	75 µL	150 µL	375 µL	750 µL	1.5 mL	3.75 mL	7.5 mL
8	6	16 µL	32 µL	80 µL	160 µL	400 µL	800 µL	1.6 mL	4.00 mL	8.0 mL
•	5	17 µL	34 µL	85 µL	170 µL	425 µL	850 µL	1.7 mL	4.25 mL	8.5 mL
9	5	18 µL	36 µL	90 µL	180 µL	450 µL	900 µL	1.8 mL	4.50 mL	9.0 mL
•	5	19 µL	38 µL	95 µL	190 µL	475 µL	950 µL	1.9 mL	4.75 mL	9.5 mL
10	5	20 µL	40 µL	100 µL	200 µL	500 µL	1000 µL	2.0 mL	5.00 mL	10.0 mL

The following table shows different ways of dispensing 50 µL:

Desired dispensing volume	Combitip advanced	Number of dispensing steps when completely filled	Position of the volume selection dial
50 µL	0.5 mL color code purple	10	5
	1.0 mL color code yellow	20	Point between 2 and 3
	2.5 mL color code green	50	1
	5.0 mL color code blue	100	First point

Select a Combitip advanced according to the following criteria:

- The desired dispensing volume is possible.
- The desired number of dispensing steps is possible.
- The geometry of the Combitip matches the geometry of the aspiration and target tubes.

### 5.1.2 Unpacking the Combitip advanced

- i** To ensure maximum protection against contamination, use Combitip advanced of the Sterile and Biopur purity grades straight after opening the packaging.

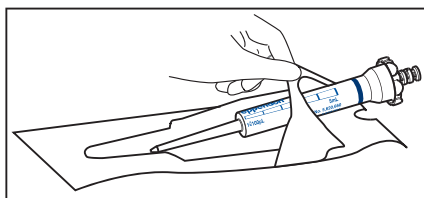

- Open the packaging at the location indicated.

### 5.1.3 Assembling the Combitip advanced and Adapter advanced

Combitips advanced with a maximum volume of 0.1 mL – 10 mL can be used immediately. Combitips advanced with a maximum volume of 25 mL or 50 mL can only be used with the corresponding Adapter advanced. Adapter advanced and Combitips advanced have the same color code. The maximum volume is also listed on the neck of the Adapter advanced.



#### **NOTICE! Sensor damage due to damaged or worn adapter**

- ▶ Always put the adapter and Combitip together outside of the dispenser.
- ▶ Do not use damaged or worn adapters.
- ▶ Do not use adapters with damaged coding.

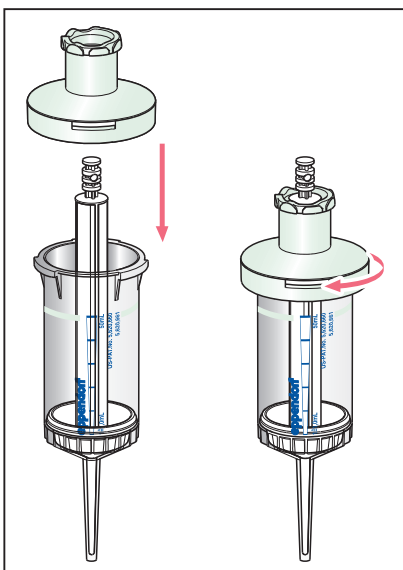

1. Place the adapter on the Combitip.
2. Tighten the adapter.

### 5.1.4 Inserting the Combitip



#### NOTICE! Device damage due to incorrect handling of the inserted Combitip

- ▶ Insert the Combitip straight into the dispenser from below.
- ▶ Do not rotate the inserted Combitip.
- ▶ Never grip the dispenser using the Combitip.



If you keep pushing the operating lever while inserting the Combitip, it will be easier to insert the Combitip.



If you want to have a different view of the text printed on the Combitip, eject the Combitip and re-insert it in a different position.

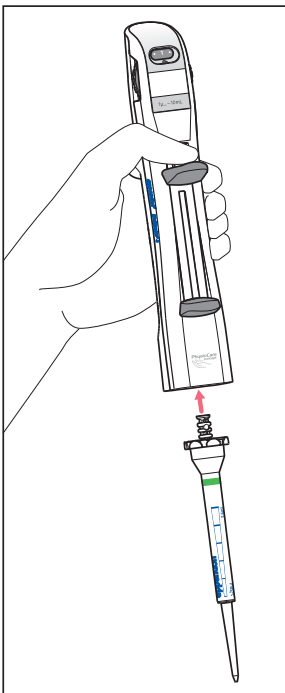

1. Push the filling lever down.
2. If the Combitip piston is pushed out, carefully push it into the Combitip cylinder.
3. Insert the Combitip straight from below. Do **not** rotate the Combitip.
4. If required, push the filling lever down again.

The display shows the following information, depending on the Combitip inserted and the position of the selection dial:

- The direction of the next piston movement: ▲
- The selected dispensing volume: 50 µL
- The maximum number of possible dispensing steps: 50



### 5.1.5 Picking up Combitips out of the rack

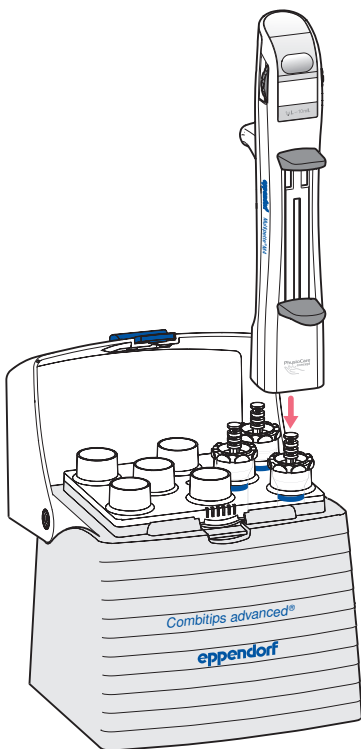

1. Push the Multipette M4/Repeater M4 onto the Combitip.
2. Push the filling lever down.

The display shows the following information, depending on the Combitip inserted and the position of the selection dial:

- The direction of the next piston movement: ▲
- The selected dispensing volume: 50 µL
- The maximum number of possible dispensing steps: 50



## 5.2 Setting the volume

The volume selection wheel has 20 positions. Every second position is marked with a figure. The other positions are marked with a dot. You can select the dispensing volume before aspiration and change it during dispensing, if required.

### 5.2.1 Setting the volume before dispensing

**i** Do **not** turn the selection dial beyond the lower or upper stop.

1. Insert the required Combitip advanced.
2. Push the filling lever down all the way.

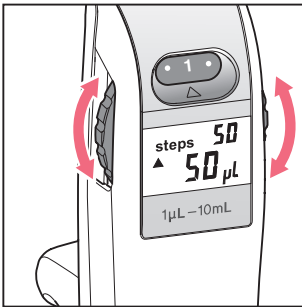

3. Turn the volume selection dial until it locks into the desired position.  
The display shows the volume and the possible dispensing steps.

**i** The Multipette M4/Repeater M4 is equipped with automatic stroke shortening. When you turn the selection dial, the stroke of the operating lever is automatically set to the selected volume. For a smaller volume, the stroke will also be shorter. When stroke shortening is active, do **not** apply force to push the operating lever up.

## 5.3 Using the step counter

On the display, the step counter shows the dispensing steps next to *steps*. The possible dispensing steps are displayed when the volume is selected. During dispensing, the dispensing steps that have been carried out are displayed.

### 5.3.1 Step counter display for Combitip filled to capacity

Prerequisites

The Combitip is inserted.

1. Set the volume.
2. Aspirate the liquid.  
The display will blink and display the possible dispensing steps.
3. Carry out a reverse stroke.  
The display shows *0* dispensing steps.
4. Dispense the liquid.  
The display shows the dispensing steps that were carried out.
5. Change the volume.  
The display shows the possible dispensing steps.
6. Dispense the liquid.  
The step counter starts again at *step 1*. The display shows the dispensing steps that were carried out.

### 5.3.2 Sequential step counter display for a Combitip that has been filled to capacity several times

#### Prerequisites

- The Combitip is inserted.
  - Volume is set.
  - Liquid has been aspirated.
  - The reverse stroke has been carried out.
-  The step counter will **not** continue to count when the Combitip is only partially filled after it has been filled to capacity.

1. Dispense the liquid.  
The display shows the dispensing steps that have already been carried out.
2. Aspirate the liquid again.  
The display shows the possible dispensing steps.
3. Carry out a reverse stroke.  
The display shows the dispensing steps that have been carried out.
4. Dispense the liquid.  
The step counter continues to count the dispensing steps that have been carried out.



### 5.3.3 Resetting the step counter to Zero when Combitip is filled repeatedly

#### Prerequisites

- The Combitip is inserted.
- Volume is set.
- Liquid has been aspirated.
- The reverse stroke has been carried out.

**i** The step counter will **not** continue to count when the Combitip is only partially filled after it has been filled to capacity.

1. Dispense the liquid.  
The display shows the dispensing steps that were carried out.
2. Push the filling lever down
3. Discard the remaining volume.  
The display flashes.
4. Aspirate the liquid again.  
The display shows the possible dispensing steps.
5. Carry out a reverse stroke.  
The display shows 0 dispensing steps.
6. Dispense the liquid.  
The display shows the dispensing steps that were carried out.

### 5.3.4 Step counter display if Combitip is partially filled

#### Prerequisites

The Combitip is inserted.

1. Set the volume.
2. Aspirate part of the liquid.  
The display flashes.
3. Carry out a reverse stroke.  
The display shows 0 dispensing steps.
4. Dispense the liquid.  
The display shows the dispensing steps that were carried out.

**i** The step counter will also continue to count when the lowest position (residual stroke lock) of the filling lever is reached!

## 5.4 Aspirating liquid

If you are aspirating solutions with a high viscosity into a Combitip with a large volume, draw up the filling lever especially slowly. This prevents any leakage occurring between the piston and the cylinder in the Combitip.

Proceed as follows:

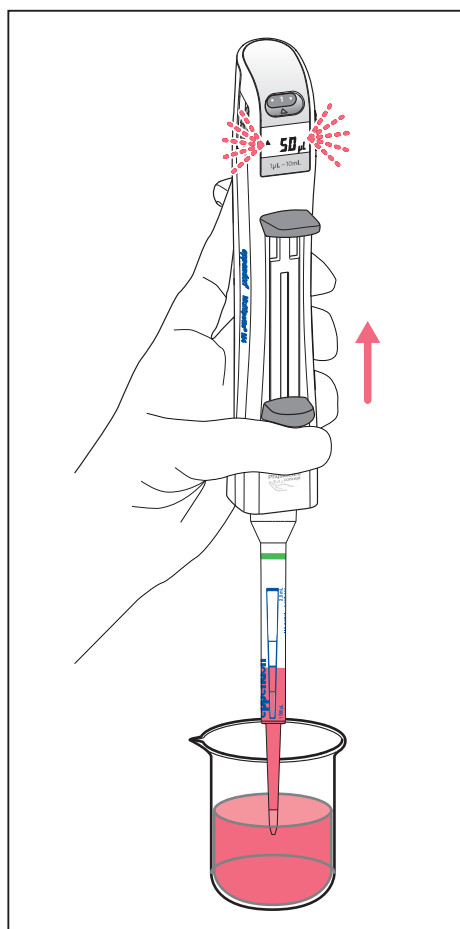

1. To ensure that the Combitip is in its basic position, push the filling lever down.
2. Immerse the tip of the Combitip in the liquid.
3. Slowly and steadily slide the filling lever up.  
The display flashes during aspiration. The small air bubble at the Combitip piston is due to technical reasons. The Combitip is completely filled when the filling lever has reached the upper stop.
4. Wipe off any outer wetting on the tip of the Combitip on the inner wall of the tube.

**i** To empty the Combitip, you can push the filling lever down at any time.

## 5.5 Dispensing liquid

### 5.5.1 Discarding the reverse stroke

During and after the liquid aspiration the display will blink. After the liquid is aspirated the reverse stroke must be triggered.

Proceed as follows:

- i
 Dispense the reverse stroke into the aspiration tube or a waste tube. The reverse stroke is not a dispensing step!
  - If you want to complete all dispensing steps using the wall dispensing method, also complete the reverse stroke using the wall dispensing method.
  - If you want to complete all dispensing steps using the free jet dispensing method, also complete the reverse stroke using the free jet dispensing method.
  - If a drip forms after free jet dispensing, this drip always belongs to the next dispensing step.

When the Combitip is filled completely, the operating lever needs to be pushed only once for the reverse stroke. If the Combitip is partially filled, you need to press the operating lever repeatedly if the selection dial setting is below 4.

Position of the volume selection dial	Number of times the operating lever was pressed for the reverse stroke
• (= 0,5)	8
1	4
• (= 1,5)	3
2	2
• (= 2,5)	2
3	2
• (= 3,5)	2
≥ 4	1

**Operation**

Multipipette® M4 · Repeater® M4  
English (EN)

1. Press the operating lever to trigger the reverse stroke.

When the reverse stroke is completed, the display will stop blinking. The *steps* display is set to 0. During the subsequent dispensing procedures the completed *steps* are displayed.

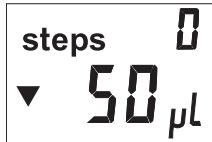

### 5.5.2 Dispensing liquid

#### Prerequisites

The liquid dispensing angle should always be as steep as possible. A dispensing angle greater than 45° can result in an incorrect dispensing volume during the final dispensing steps.

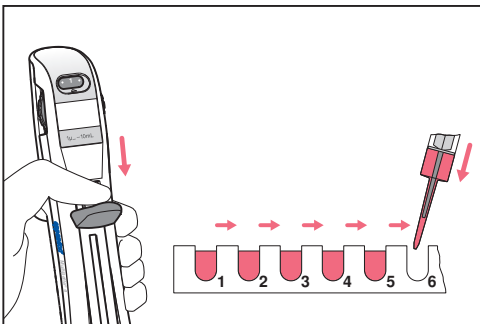

1. Place the tip of the Combitip at a steep angle on the inner wall of the target tube (wall dispensing) or hold the Combitip over the target tube (free jet dispensing).

2. Push the operating lever down as far as it will go.

The display shows the *steps* and the number of dispensing steps performed.



The faster you push the operating lever down, the faster the liquid is dispensed. Adjust the liquid dispensing to the tube geometry to prevent liquid splashing out of the tube. For highly viscous liquids, always operate the operating lever very slowly.

3. Let the operating lever slide back fully to its initial position.
4. Push the operating lever down again to perform the next dispensing step.  
 If there is not enough liquid for the selected dispensing volume, the residual stroke lock will prevent any further dispensing operations. No liquid will be dispensed when you press the operating lever.

After the residual stroke lock is activated you have 2 options:

- **Renewed aspiration**

- a Slide the filling lever up to aspirate liquid.
- b Press the operating lever to trigger the reverse stroke. When the Combitip is partly filled, you need to push the operating lever several times (volume selection dial < 4).
- c Continue dispensing.

When the Combitip advanced is filled completely, the dispensing steps will continue to be counted. A maximum of 999 dispensing steps can be counted.

- **Empty the Combitip advanced**

- a Hold the Combitip advanced over the waste tube.
- b To empty the Combitip advanced completely, push the filling lever down as far as it will go.

If you now re-fill the Combitip advanced or use a different Combitip advanced, counting the dispensing steps will re-start at 1.

## 5.6 Ejecting the Combitip advanced

To eject the Combitip, it must be completely empty.

Proceed as follows:

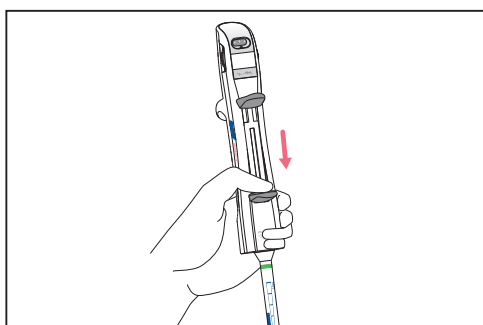

1. Start by pushing the filling lever down as far as it will go.  
 The display flashes. On the display, the ▼symbol appears.



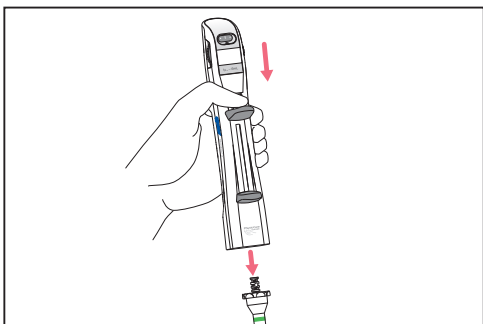

2. Push the operating lever down.  
The Combitip is ejected.

3. Dispose of the Combitip advanced.

### 5.6.1 Combitip advanced 25 mL and 50 mL

1. Unscrew the reusable Adapter advanced from the Combitip advanced.
2. If required, rinse the Adapter advanced with demineralized water and dry.

**i** The Adapter advanced is a wear part. Do not reuse the adapter if it shows any visible signs of wear. An Adapter advanced is included in each box of 25 mL or 50 mL Combitips advanced.

### 5.7 Dispensing with an empty battery



The Multipette M4/Repeater M4 is also operational when the battery is empty.

- ▶ Use the volume table to set the volumes (see p. 24).

## 6 Troubleshooting

### 6.1 General errors

#### 6.1.1 Battery

Symptom/message	Cause	Remedy
The battery symbol  appears on the display.	<ul style="list-style-type: none"> <li>Battery capacity is very low.</li> </ul>	<ul style="list-style-type: none"> <li>▶ Replace the battery.</li> </ul>
The battery symbol  appears on the display.	<ul style="list-style-type: none"> <li>Battery capacity is extremely low.</li> </ul>	<ul style="list-style-type: none"> <li>▶ Replace the battery immediately.</li> </ul>

#### 6.1.2 Combitip advanced

Symptom/message	Cause	Remedy
Combitip cannot be inserted.	<ul style="list-style-type: none"> <li>No Combitip advanced used.</li> </ul>	<ul style="list-style-type: none"> <li>▶ Insert Combitip advanced.</li> </ul>
Combitip cannot be filled.	<ul style="list-style-type: none"> <li>No Combitip advanced used.</li> </ul>	<ul style="list-style-type: none"> <li>▶ Insert Combitip advanced.</li> </ul>
Combitip cannot be ejected.	<ul style="list-style-type: none"> <li>Filling lever not pushed down fully.</li> <li>Operating lever not fully operated.</li> </ul>	<ol style="list-style-type: none"> <li>1. Push the filling lever down as far as it will go.</li> <li>2. Operate the operating lever firmly and centered.</li> </ol>

## 6.1.3 Display

Symptom/message	Cause	Remedy
Display remains dark.	• No Combitip advanced used.	▶ Insert Combitip advanced.
	• Battery fully discharged.	▶ Replace the battery.
	• Combitip sensor faulty.	▶ Call service.
	• Movement sensor faulty.	▶ Call service.
Number of the <i>steps</i> shown on the display is incorrect.	• Incorrect interpretation of the information.	▶ When selecting the volume, the possible dispensing steps are displayed. ▶ After the reverse stroke, the dispensing steps that were carried out are displayed.
	• Operating lever not fully pushed.	▶ Always push the operating lever down as far as it will go.



### 6.1.4 Error codes

Symptom/message	Cause	Remedy
C02 Err C03 Err	<ul style="list-style-type: none"> <li>• Combitip advanced very heavily bent or distorted during and after inserting.</li> </ul>	<ul style="list-style-type: none"> <li>▶ Do not bend or distort inserted Combitip advanced.</li> </ul>
	<ul style="list-style-type: none"> <li>• Combitip advanced incorrectly or not fully inserted.</li> </ul>	<ol style="list-style-type: none"> <li>1. Press the filling lever down all the way.</li> <li>2. Operate the operating lever to eject the Combitip advanced.</li> <li>3. Check the Combitip advanced or the Adapter advanced for damage to the coding.</li> </ol>
	<ul style="list-style-type: none"> <li>• Combitip advanced not fully released.</li> </ul>	<ul style="list-style-type: none"> <li>▶ Operate the operating lever again fully and centered to eject the Combitip advanced.</li> </ul>
	<ul style="list-style-type: none"> <li>• Coding on the Combitip advanced or on the Adapter advanced faulty.</li> </ul>	<ul style="list-style-type: none"> <li>▶ Insert a new Combitip advanced.</li> </ul>
S03 Err	<ul style="list-style-type: none"> <li>• Volume selection dial not engaged.</li> </ul>	<ul style="list-style-type: none"> <li>▶ Let the number or point engage exactly above the position display.</li> </ul>

### 6.1.5 Aspirating liquid

Symptom/message	Cause	Remedy
Large air bubble in Combitip advanced after the liquid has been aspirated.	<ul style="list-style-type: none"> <li>• Air has been aspirated while aspirating the liquid.</li> </ul>	<ul style="list-style-type: none"> <li>▶ Re-aspirate the liquid.</li> </ul>
	<ul style="list-style-type: none"> <li>• Highly viscous liquid has been aspirated too quickly.</li> </ul>	<ul style="list-style-type: none"> <li>▶ Aspirate liquid more slowly.</li> </ul>
	<ul style="list-style-type: none"> <li>• Lag time of the liquid not observed.</li> </ul>	<ul style="list-style-type: none"> <li>▶ Aspirate liquid more slowly.</li> </ul>

### 6.1.6 Measurement errors

Symptom/message	Cause	Remedy
Systematic and/or random error is too high.	<ul style="list-style-type: none"> <li>• Reverse stroke given as dispensing volume by mistake.</li> </ul>	▶ Repeat dispensing.
	<ul style="list-style-type: none"> <li>• Operating lever not fully pushed during dispensing.</li> </ul>	▶ Repeat dispensing.
	<ul style="list-style-type: none"> <li>• Combitip advanced used too many times, too old.</li> </ul>	▶ Repeat dispensing.
	<ul style="list-style-type: none"> <li>• Not enough liquid was aspirated.</li> </ul>	▶ Repeat dispensing.
	<ul style="list-style-type: none"> <li>• Many air bubbles in the aspirated liquid.</li> <li>• Combitip held at an incorrect angle during dispensing</li> </ul>	▶ Repeat dispensing.

Regularly check the precision and accuracy of the Multipette M4/Repeater M4 with the Combitips advanced lots you are using to prevent dispensing errors. You can use the "PICASO" software to determine the maximum permissible systematic and random errors.

A Standard Operation Procedure (SOP) for the inspection is available on the CD Multipette M4/Repeater M4 and on our webpage.

## 7 Maintenance

### 7.1 Cleaning

---



**NOTICE! Damage to device from unsuitable cleaning fluids or sharp or pointed objects.**

Unsuitable cleaning fluids can damage the device.

- ▶ Never use corrosive cleaning fluids, strong solvents or abrasive polishes.
- ▶ Check the compatibility with the materials used.
- ▶ Please note the information on chemical resistance (see CD).
- ▶ Do **not** clean the Multipipette M4/Repeater M4 with acetone or organic solvents with a similar effect.
- ▶ Do **not** clean the Multipipette M4/Repeater M4 with sharp objects.





**NOTICE! Damage to the device due to penetration of liquids.**

- ▶ Do not allow any liquids to penetrate the inside of the housing.
  - ▶ If liquid has entered the inside of the housing, the inner parts may only be repaired by Eppendorf AG service partners. Contact your local sales office before returning any devices.
- 

Proceed as follows:

- ▶ To remove any contamination on the outside, dampen a soft cloth with a mild detergent and wipe the housing.
- ▶ To disinfect the dispenser, wipe the housing with isopropanol (70 %) .
- ▶ Rinse the Adapter advanced with demineralized water and dry.
- ▶ The Adapter advanced can be steam autoclaved at 121 °C at an overpressure of 1 bar for 20 min. The Adapter advanced can be autoclaved a maximum of 100 times.
- ▶ The Combitip rack advanced can be steam autoclaved at 121 °C at an overpressure of 1 bar for 20 min. The Combitip rack advanced can be autoclaved a maximum of 100 times.

## 7.2 Replacing the battery

When the display shows the battery symbol  this indicates that the battery can be used for approx. another 2 weeks. When the display shows the  battery symbol, you need to replace the battery. Proceed as follows:

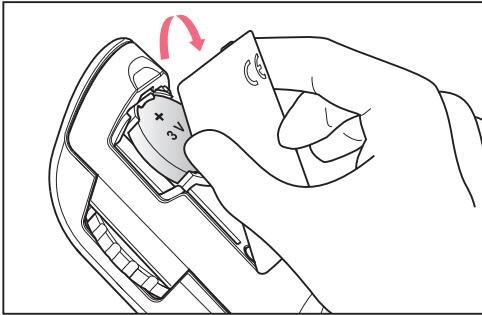

1. Remove the battery compartment lid.

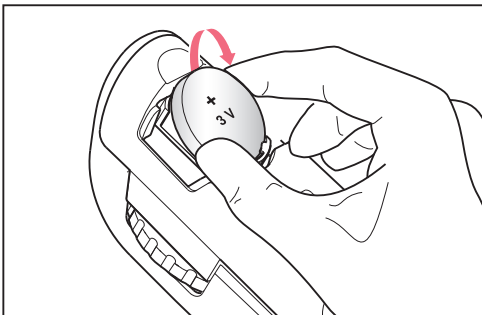

2. Grip the battery at the sides and remove.

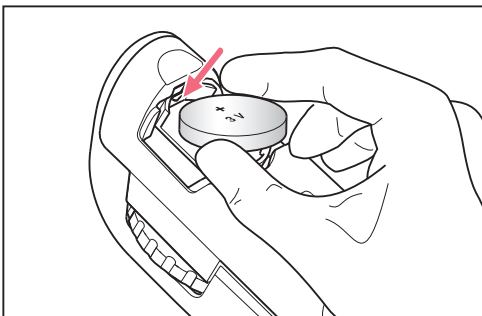

3. Hold the battery at the sides.  
The + symbol faces the user.
4. Insert the battery at the top and then let it click into place at the bottom.  
After electrical contact: the display switches on briefly and all segments light up briefly.
5. Close the battery compartment lid

## 7.3 Decontamination before shipment

If you wish to return the device to Eppendorf AG or an Eppendorf AG service partner to be checked or repaired, please note the following:



**CAUTION! Use of a contaminated device may result in personal injuries and damage to the device.**

- ▶ Clean and decontaminate the Multipipette M4/Repeater M4 in accordance with the cleaning instructions before shipping or storage.
- 

Hazardous substances are:

- solutions presenting a hazard to health
  - potentially infectious agents
  - organic solvents and reagents
  - radioactive substances
  - proteins presenting a hazard to health
  - DNA
1. Please note the information in the document "Decontamination certificate for product returns".  
You can find it as a PDF file on our webpage [www.eppendorf.com](http://www.eppendorf.com).  
The decontamination certificate can also be found on the enclosed CD.
  2. Enter the serial number of the Multipipette M4/Repeater M4 in the decontamination certificate.
  3. With the shipment please include the completed decontamination certificate for product returns with the Multipipette M4/Repeater M4.
  4. Send the pipette to Eppendorf AG or an Eppendorf AG service partner. The address details of Eppendorf AG can be found on the last page of this operating manual. The list of service partners can be found at [www.eppendorf.com/worldwide](http://www.eppendorf.com/worldwide).

## 8 Technical data

<b>Multipette M4/Repeater M4</b>	
Weight	105 g
<b>Battery</b>	
Type	Button cell
Voltage	3 V
Operational life	approx. 2 years

### 8.1 Measurement errors

Combitip advanced	Testing volume	Error limits			
		Error			
		Systematic error		Random error	
		± %	± µL	± %	± µL
0.1 mL white Increment: 1 µL	2 µL	±1.6	±0.032	±3.0	±0.06
	20 µL	±1.0	±0.2	±2.0	±0.4
0.2 mL light blue Increment: 2 µL	4 µL	±1.3	±0.052	±2.0	±0.08
	40 µL	±0.8	±0.32	±1.5	±0.6
0.5 mL purple Increment: 5 µL	10 µL	±0.9	±0.09	±1.5	±0.15
	100 µL	±0.8	±0.8	±0.6	±0.6
1 mL yellow Increment: 10 µL	20 µL	±0.9	±0.18	±0.9	±0.18
	200 µL	±0.6	±1.2	±0.4	±0.8

**Technical data**

Multipette® M4 · Repeater® M4  
English (EN)

Combitip advanced	Testing volume	Error limits			
		Error			
		Systematic error		Random error	
		± %	± µL	± %	± µL
2.5 mL green Increment: 25 µL	50 µL	±0.8	±0.4	±0.8	±0.4
	500 µL	±0.5	±2.5	±0.3	±1.5
5 mL blue Increment: 50 µL	100 µL	±0.6	±0.6	±0.6	±0.6
	1000 µL	±0.5	±5.0	±0.25	±2.5
10 mL orange Increment: 0.1 mL	200 µL 0.2 mL	±0.5	±1.0	±0.6	±1.2
	2000 µL 2 mL	±0.5	±10	±0.25	±5.0
25 mL red Increment: 0.25 mL	500 µL 0.5 mL	±0.4	±2.0	±0.6	±3.0
	5000 µL 5 mL	±0.3	±15	±0.25	±12.5
50 mL light gray Increment: 0.5 mL	1000 µL 1 mL	±0.3	±3.0	±0.5	±5.0
	10000 µL 10 mL	±0.3	±30	±0.3	±30



Test conditions and test evaluation in compliance with ISO 8655, Part 6. Test using a standardized fine balance with a moisture trap.

- Number of determinations:10
  - Use of water in accordance with ISO 3696
  - Test was carried out with a Combitip advanced that was filled to capacity
  - Test was carried out at 20 °C – 27 °C ±0.5 °C
  - Dispensing onto the tube wall
-  The test volumes for the systematic and random errors of the Multipette M4/Repeater M4 comply with the requirements of ISO 8655, part 5.

Technical specifications subject to change.

## 8.2 Ambient conditions

Ambience	Only for use indoors.
Ambient temperature	5 °C – 40 °C
Relative humidity	10 % – 95 %, non-condensing.
Atmospheric pressure	795 hPa – 1060 hPa

## 9 Transport, storage and disposal

### 9.1 Transport

- ▶ Use the original packaging for transport.

	Air temperature	Relative humidity	Atmospheric pressure
General transport	-25 °C – 60 °C	10 % – 95 %	300 hPa – 1060 hPa
Air freight	-40 °C – 45 °C	10 % – 95 %	300 hPa – 1060 hPa

### 9.2 Storage



#### **NOTICE! Damage to device due to incorrect storage.**

- ▶ Remove the battery if you will not be using the Multipette M4/ Repeater M4 for longer periods of time.
- ▶ Do not clean the Multipette M4/Repeater M4 while the Combitip is inserted.
- ▶ Select a secure storage location.
- ▶ Do not expose the Multipette M4/Repeater M4 to aggressive gases over a longer period of time.



#### **NOTICE! Damage due to UV radiation**

- ▶ Do not store consumables in areas with strong UV radiation.

	Air temperature	Relative humidity	Atmospheric pressure
In transport packaging	-25 °C – 55 °C	10 % – 95 %	700 hPa – 1060 hPa
Without transport packaging	-5 °C – 45 °C	10 % – 95 %	700 hPa – 1060 hPa

## 9.3 Disposal

In case the product is to be disposed of, the relevant legal regulations are to be observed.

### Information on the disposal of electrical and electronic devices in the European Community:

Within the European Community, the disposal of electrical devices is regulated by national regulations based on EU Directive 2002/96/EC pertaining to waste electrical and electronic equipment (WEEE).

According to these regulations, any devices supplied after August 13, 2005, in the business-to-business sphere, to which this product is assigned, may no longer be disposed of in municipal or domestic waste. They are marked with the following symbol to indicate this:

As disposal regulations may differ from country to country within the EU, please contact your supplier if necessary.



### **WARNING! Risk of explosion and fire due to overheated accumulators and batteries.**

- ▶ Do not heat accumulators and batteries to over 80 °C and do not throw them into fires.

---

### **Disposing of accumulators and batteries**

Do not dispose of accumulators and batteries as household waste. Dispose of accumulators and batteries according to the locally applicable legal regulations.



## 10 Ordering Information

### 10.0.1 Multipette M4/Repeater M4

<b>Order no. (International)</b>	<b>Order no. (North America)</b>	<b>Description</b>
4982 000.012	–	<b>Multipette M4</b>
–	4982000020	<b>Repeater M4</b>
4982 000.314	–	<b>Multipette M4 Starter Kit</b> Multipette M4, Combitip Rack, Combitip Assortmentpack
–	4982000322	<b>Repeater M4 Starter Kit</b> Repeater M4, Combitip Rack, Combitip Assortmentpack

## 10.0.2 Accessories



**CAUTION! Poor safety due to incorrect accessories and spare parts.**

The use of accessories and spare parts other than those recommended by Eppendorf may impair the safety, functioning and precision of the device. Eppendorf cannot be held liable or accept any liability for damage resulting from the use of incorrect or non-recommended accessories and spare parts, or from the improper use of such equipment.

- ▶ Only use accessories and original spare parts recommended by Eppendorf.

Order no. (International)	Order no. (North America)	Description
3115 000.003	022444905	<b>Pipette carousel 3115</b> with 6 pipette holder for Research and Reference Pipettes
4982 602.004	4982602004	<b>Holder</b> for Multipette M4
4982 603.000	4982603000	<b>Hook-and-loop tape</b> for holder
4980 215.003	022269119	<b>Battery</b> 3 V

## 10.1 Combitips advanced

Order no. (International)	Order no. (North America)	Description
0030 089.405 – 0030 089.618 0030 089.766	0030089405 0030089510 0030089618 –	<b>Combitips advanced 0.1 mL</b> 100 pieces Eppendorf Quality Sterile, individually wrapped Biopur, individually wrapped PCR clean
0030 089.413 – 0030 089.626 0030 089.774	0030089413 0030089529 0030089626 –	<b>Combitips advanced 0.2 mL</b> 100 pieces Eppendorf Quality Sterile, individually wrapped Biopur, individually wrapped PCR clean
0030 089.421 – 0030 089.634 0030 089.782	0030089421 0030089537 0030089634 –	<b>Combitips advanced 0.5 mL</b> 100 pieces Eppendorf Quality Sterile, individually wrapped Biopur, individually wrapped PCR clean
0030 089.430 – 0030 089.642 0030 089.790	0030089430 0030089545 0030089642 –	<b>Combitips advanced 1.0 mL</b> 100 pieces Eppendorf Quality Sterile, individually wrapped Biopur, individually wrapped PCR clean
0030 089.448 – 0030 089.650 0030 089.804	0030089448 0030089553 0030089650 –	<b>Combitips advanced 2.5 mL</b> 100 pieces Eppendorf Quality Sterile, individually wrapped Biopur, individually wrapped PCR clean

Order no. (International)	Order no. (North America)	Description
0030 089.456 – 0030 089.669 0030 089.812	0030089456 0030089561 0030089669 –	<b>Combitips advanced 5.0 mL</b> 100 pieces Eppendorf Quality Sterile, individually wrapped Biopur, individually wrapped PCR clean
0030 089.464 – 0030 089.677 0030 089.820	0030089464 0030089570 0030089677 –	<b>Combitips advanced 10 mL</b> 100 pieces Eppendorf Quality Sterile, individually wrapped Biopur, individually wrapped PCR clean
0030 089.472 – 0030 089.685 0030 089.839	0030089472 0030089588 0030089685 –	<b>Combitips advanced 25 mL</b> 100 pieces + 4 Adapter Eppendorf Quality Sterile, individually wrapped Biopur, individually wrapped PCR clean
0030 089.480 – 0030 089.693 0030 089.847	0030089480 0030089596 0030089693 –	<b>Combitips advanced 50 mL</b> 100 pieces + 4 Adapter Eppendorf Quality Sterile, individually wrapped Biopur, individually wrapped PCR clean
<b>Order no. (International)</b>	<b>Order no. (North America)</b>	<b>Description</b>
0030 089.715	0030089715	<b>Adapter advanced 25 mL</b> 1 piece Eppendorf Quality
0030 089.723	0030089723	<b>Adapter advanced 50 mL</b> 1 piece Eppendorf Quality

**Ordering Information**Multipette® M4 · Repeater® M4  
English (EN)

<b>Order no. (International)</b>	<b>Order no. (North America)</b>	<b>Description</b>
0030 089.731	0030089731	<b>Adapter advanced 25 mL</b> 7 pieces Biopur, individually wrapped
0030 089.740	0030089740	<b>Adapter advanced 50 mL</b> 7 pieces Biopur, individually wrapped



## 10.2 Accessories

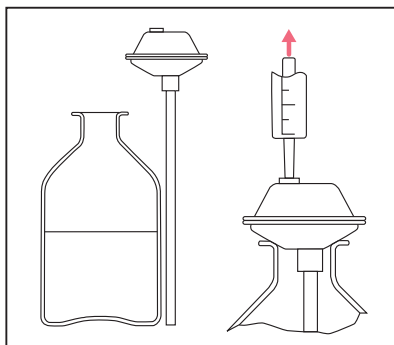

### Combilong/Combitube

The Combilong/Combitube is an aspiration tool for the Combitips advanced. It enables liquids to be directly taken out of all bottles.

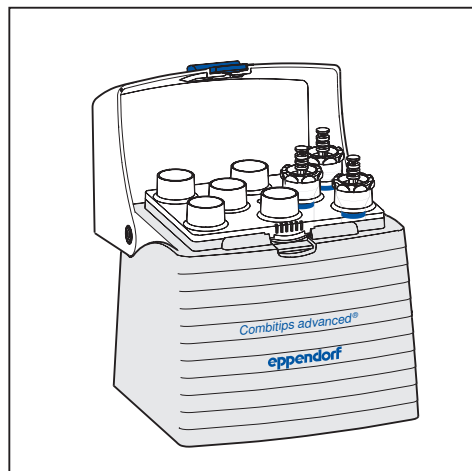

### Combitips advanced Rack

A Combitips advanced Rack is available for storing the Combitips advanced ( $\leq 10$  mL).

Order no. (International)	Order no. (North America)	Description
0030 059.506	–	<b>Combilong</b> Aspirating aid for removing liquids from volumetric flasks and tall bottles 2 pieces
–	022261550	<b>Combitube</b> Aspirating aid for removing liquids from volumetric flasks and tall bottles 2 pieces
0030 089.758	0030089758	<b>Combitips advanced Rack</b> 1 piece Eppendorf Quality

**Index****A**

Adapter advanced	
Autoclaving .....	44
Autoclaving .....	44

**B**

Battery	
Replace .....	45

**C**

Cleaning .....	44
Cleaning agents	
Isopropanol .....	44
Color code	
Color code .....	19
Combitip	
Adapter .....	38
Assembly .....	27
Color code .....	19
Eject .....	37
Insert .....	24, 28
Rack .....	29
Unpacking .....	26
Volume table .....	25
Combitip rack	
Autoclaving .....	44

**D**

Delivery package .....	20
Display .....	16

Sleep function .....	16
----------------------	----

Disposal .....	51
----------------	----

**F**

Free jet dispensing .....	36
---------------------------	----

**H**

Holder	
Carousel .....	23
Wall .....	22

**L**

Liquid	
Aspiration .....	34
Dispensing .....	35, 36
Free jet dispensing .....	36
Reverse stroke .....	35
Wall dispensing .....	36

**M**

Material .....	20
Measurement errors .....	47

**R**

Reverse stroke .....	35
----------------------	----

**S**

Selection dial settings .....	35
Sleep function	
Display .....	16
Step counter .....	31

steps.....	31
steps	
Step counter.....	31
Storage .....	50

## T

### Technical data

Ambient conditions.....	49
Battery for M4.....	47
Multipette M4/Repeater M4 .....	47

### Troubleshooting

Aspirating liquid .....	42
Battery .....	39
Combitip advanced .....	39
Display .....	40
Error codes .....	41
Measurement errors .....	43

## V

### Volume

Setting.....	30
Volume table .....	25

## W

Wall dispensing .....	36
Warranty.....	21

# Declaration of Conformity

The product named below fulfills the requirements of directives and standards listed. In the case of unauthorized modifications to the product or an unintended use this declaration becomes invalid.

**Product name:**

Multipette® M4 / Repeater® M4

**Product type:**

Manual dispenser

**Relevant directives / standards:**

2014/35/EU EN 61010- 1

2014/30/EU EN 55011, EN 61326- 1

2011/65/EU EN 50581

EN ISO 8655- 1, EN ISO 8655- 5, EN ISO 8655- 6

Date: February 16, 2016



Management Board



Portfolio Management

Your local distributor: [www.eppendorf.com/contact](http://www.eppendorf.com/contact)  
Eppendorf AG · 22331 Hamburg · Germany  
[eppendorf@eppendorf.com](mailto:eppendorf@eppendorf.com)

Eppendorf® and the Eppendorf logo are registered trademarks of Eppendorf AG, Germany.  
U.S. Design Patents are listed on [www.eppendorf.com/ip](http://www.eppendorf.com/ip).  
All rights reserved, incl. graphics and pictures. Copyright 2015 © by Eppendorf AG.

[www.eppendorf.com](http://www.eppendorf.com)

ISO 9001  
Certified

ISO  
13485  
Certified

ISO  
14001  
Certified

# Evaluate Your manual

Give us your feedback.

[www.eppendorf.com/manualfeedback](http://www.eppendorf.com/manualfeedback)

**Your local distributor: [www.eppendorf.com/worldwide](http://www.eppendorf.com/worldwide)**

Eppendorf AG · Hamburg · Germany · Phone: +49 40 538 01-0