

User Manual

SSA-20 - CO₂ Incubator Analyser

Table of Contents

- 1 Introduction3
- 2 Getting Started.....4
 - 2.1 Case contents4
 - 2.2 Device Layout5
 - 2.3 Charging the battery6
 - 2.4 Connecting the tubing and filter7
- 3 Operation.....8
 - 3.1 Switching the unit ON/OFF.....8
 - 3.2 Indicator icons8
 - 3.3 Home Screen layout9
 - 3.4 Using the touch screen..... 9
 - 3.5 Sampling/Measuring Mode..... 10
 - 3.6 Resolution adjustment 10
 - 3.7 Measurement procedure 10
- 4 Calibration 11
 - 4.1 Calibrate in Air.....11
 - 4.2 Calibrate in Nitrogen11
 - 4.3 Reference to Calibrated Gas11
- 5 Available Accessories 13
- 6 Service, Factory Calibration, Technical Support & Warranty 14

1. Introduction

Thank you for purchasing our SSA-20 CO₂ analyser.

The SSA-20 is the new handheld CO₂ analyser specially designed by Samson Scientific to measure, verify and validate the CO₂ levels on CO₂ Incubators. The SSA-20 offers the user an easy to use and accurate CO₂ analysis tool with the backup of our excellent after sales support package.

Easy to use

Fast and intuitive touch screen driven user interface.

It's fast

Solid state sensor technology with extremely fast start time and minimal warm up mean the SSA-20 can practically complete its full check and measurement cycle before other Analysers have even got the splash screen out of the way.

The SSA-20 CO₂ Analyser is extremely easy to use but it is essential that these Operating Instructions are read prior to use.

Copyright

Copyright © 2023 Samson Scientific Ltd

No part of this User Manual may be reproduced, distributed, translated, or transmitted in any form or by any means, electronic or mechanical, including photocopying, recording, or storing in any information storage and retrieval system, without the prior permission of Samson Scientific.

2. Getting Started

2.1 Case contents

1. SSA-20 CO2 Analyser
2. 1 metre of sample tubing with filter and 1 x Spare Filter
3. User Manual
4. Mains charger with UK AC head
5. USB A Male to Mini USB 1.8m lead for connection to supplied mains charger or PC.
6. US, EU and AU Mains charger heads



Getting Started

2.2 Device Layout

1. On/Off Button
2. Gas Inlet Luer
3. Touch screen
4. USB/ charging port
5. Tilt stand
6. Gas outlet



Getting Started

2.3 Charging the battery

Use the charger to charge the battery before using it for the first time. A computer can be also used to charge the device by connecting them via the USB cable.

NOTE: The device should always be switched On while charging.

The device can be used while it is charging, but it may take longer to fully charge the battery.

IMPORTANT NOTE: Use only Samson Scientific approved chargers, batteries, and cables. Unapproved chargers or cables can cause the battery to explode or damage the device.

Charging with the charger

Connect the USB cable to the USB power adaptor and then plug the end of the USB cable into the SSA-20 USB port.

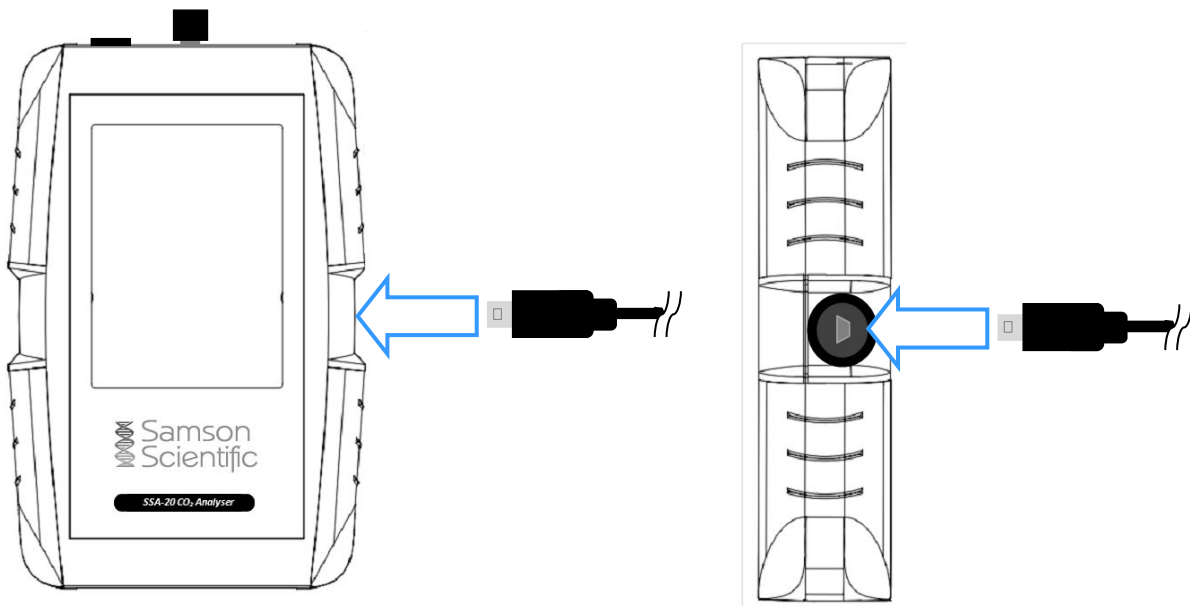

IMPORTANT NOTE: Connecting the charger improperly may cause serious damage to the device. Any damage caused by misuse is not covered by the warranty.

Checking the battery charge status

When charging the device, the battery charge status icon will appear in the middle of the screen:



After fully charging, disconnect the device from the charger.

Getting Started

2.4 Connecting the tubing and filter

IMPORTANT NOTE: Always ensure that the filter provided is used when sampling.

Connect the filter and tube to the gas inlet luer connector as shown below by inserting the filter onto the luer and twisting the filter clockwise while turning the black luer lock anti clockwise to lock. Ensure the connection is tight before taking any measurements.

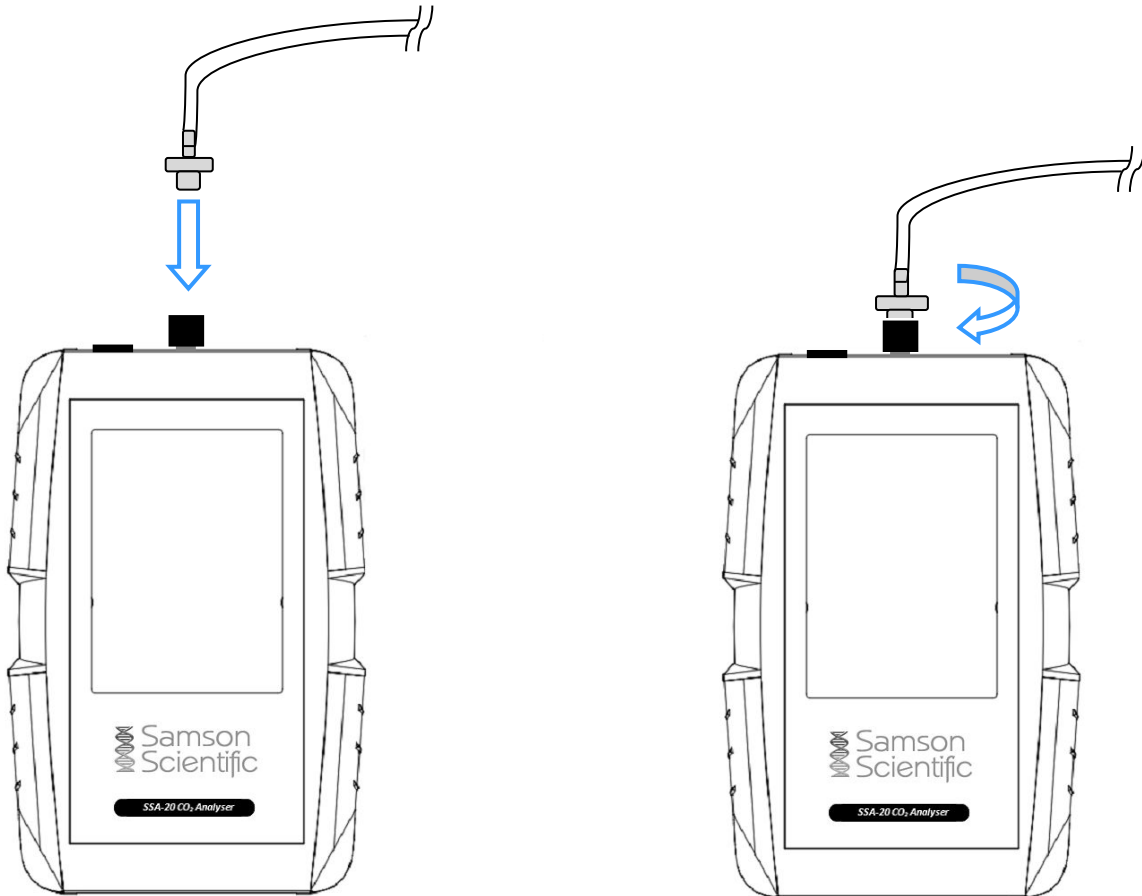

3. Operation

3.1 Switching the unit ON/OFF

Press the  button. The unit is now switched on.

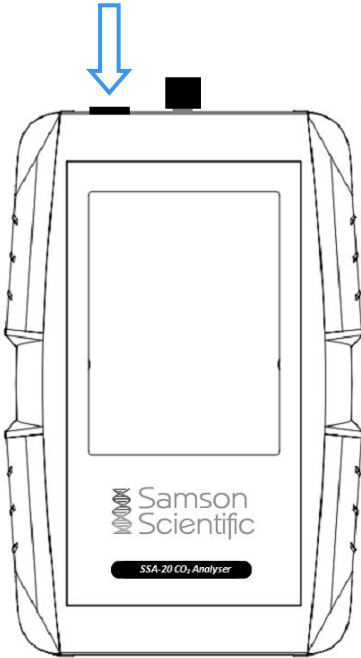





After being turned on, the SSA-20 will start up within 6 seconds and the current CO₂ measured value will be displayed.

To turn the SSA-20 Analyser off, press the  button again.

3.2 Indicator icons

The icons displayed on the screen provide information about the status of the device. The icons listed in the table below are most common.

Icon	Meaning
	Battery power level
	Pump running
	Measurement 'Hold' enabled
	Battery level low connect charger

Operation

3.3 Home Screen layout

The Home screen of the SSA-20 is the starting point to access all of the device's features. It displays the currently measured "PERCENT CO2" level, indicator icons, Hold, Menu and Pump buttons.

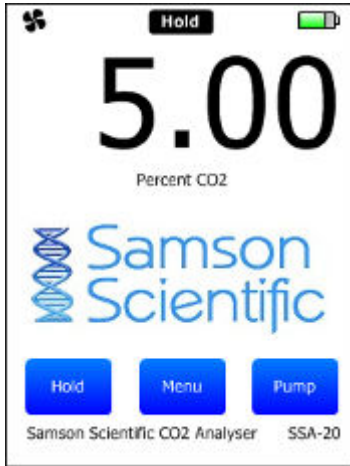

3.4 Using the touch screen

IMPORTANT NOTE: Use only fingers to use the touch screen.

- Do not allow the touch screen to come into contact with other electrical devices as electrostatic discharges could cause the touch screen to malfunction.
- Do not allow the touch screen to come into contact with water. The touch screen may malfunction in humid conditions or when exposed to water.
- To avoid damaging the touch screen, do not tap it with anything sharp or apply excessive pressure to it with your fingertips.

To operate any of the on-screen buttons, tap it with a finger.



Operation

3.5 Sampling/Measuring Mode

IMPORTANT NOTE: Always ensure that the filters provided are used and replaced regularly
IMPORTANT NOTE: Before each day of use we recommend that the SSA-20 is zeroed in air by following the “Calibrate in Air” procedure in Section 4.1 on Page 11.

To turn on the integral gas pump, briefly press the **Pump** button.
To turn off the pump, again briefly press the **Pump** button.

3.6 Resolution adjustment

To adjust the measurement resolution from 1 decimal place to 2 decimal places tap the “Percent CO2” area of the screen.

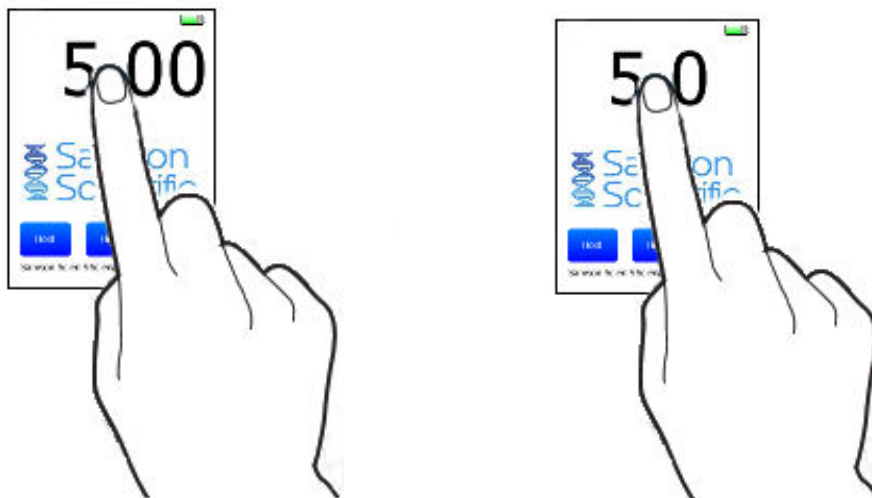

3.7 Measurement procedure

When sampling the CO2 level of a CO2 Incubator, connect the SSA-20 tubing to the sample port and press the **Pump** button to turn on the metering gas pump. Ensure the outlet port at the rear is not covered during the measurement procedure if the tilt stand is not locked in place.

A sample of the atmosphere from the CO2 Incubator will then be drawn in through the tube and the “PERCENT CO2” reading will start to change as the gas to be measured is drawn into the unit.

Monitor the reading until it stabilises. This will typically take around 90 seconds.

Take note of the reading and press the **Pump** button to turn off the metering gas pump.

After sampling, press the **Pump** button to run the pump again in air for 30 seconds to purge the analyser with air and press the **Pump** button to turn off the pump.

IMPORTANT NOTE: As the atmosphere in an incubator is normally kept at a high humidity level we recommend that you DO NOT leave the analyser sampling on a humidified incubator for longer than 2 minutes. After sampling on a humidified Incubator for a long period we recommend that you continue to run the analyser pump in air for 30 seconds to flush out any humidity which could have built up inside the sensor.

4. Calibration

IMPORTANT NOTE: Before each day of use we recommend that the SSA-20 is zeroed in air by following the “Calibrate in Air” procedure below.

Zero Calibration

The SSA-20 can be calibrated in clean outside air or by using Nitrogen. See either step 4.1 or 4.2 below.

4.1 Calibrate in Air

IMPORTANT NOTE: It is essential to ensure that the unit is in clean air in an outdoor environment before attempting an air calibration and ensure that your exhaled breath does not affect the procedure. Failure to adhere to these guidelines could result in an incorrect calibration result.

From the home screen press **Menu**

Press **Calibrate in Air** and follow the on-screen instructions.

Press the **Pump** button and run the pump for 90 seconds. Ensure the outlet port at the rear is not covered during the procedure if the tilt stand is not locked in place.

When the reading has stabilised, press **Calibrate** and the SSA-20 will adjust the level to atmospheric CO₂ level of 0.04%.

Press the **Pump** button to switch off the pump.

Press the **Back** button three times to return to the home screen.

4.2 Calibrate in Nitrogen

From the home screen press **Menu**

Press **Calibrate in Nitrogen** and follow the on-screen instructions.

Connect a Nitrogen source with pressure set no higher than 0.3L/min and flow the gas for at least 90 seconds. Ensure the outlet port at the rear is not covered during the procedure if the tilt stand is not locked in place.

When the reading has stabilised, press **Calibrate** and the SSA-20 will adjust the level to CO₂ 0.00%.

Press the **Back** button three times to return to the home screen.

4.3 Reference to Calibrated Gas

IMPORTANT NOTE: There should be no requirement to Reference the SSA-20 to a calibrated gas mixture between service intervals as performing the “Calibrate in Air” function should keep the unit within spec but if you wish to verify the calibration using a calibrated gas mixture it is essential to ensure that the unit is zeroed in clean air in an outdoor environment before referencing. Incorrect calibration of the SSA-20 could affect the measurement accuracy.

Follow the instructions below or refer to the diagrams on Page 12:

From the home screen press **Menu**

Press **Reference to Calibrated Gas** and follow the on-screen instructions.

Connect a calibration gas supply with pressure set no higher than 0.3L/min and flow the gas for at least 90 seconds.

The default calibration value in this screen is 5.00. NOTE: If you are using a CO₂ gas mixture other than 5.00% then enter the value of your calibration gas cylinder by using the **Down** and **Up** buttons. The value can be adjusted to any level from 0-21%.

When the reading has stabilised, press **Calibrate** and the SSA-20 will adjust the measured level to CO₂ 5.00%.

Turn off the gas supply and press the **Pump** button to switch off the pump.

Press the **Back** button three times to return to the home screen.

Press **Reference to Calibrated Gas**

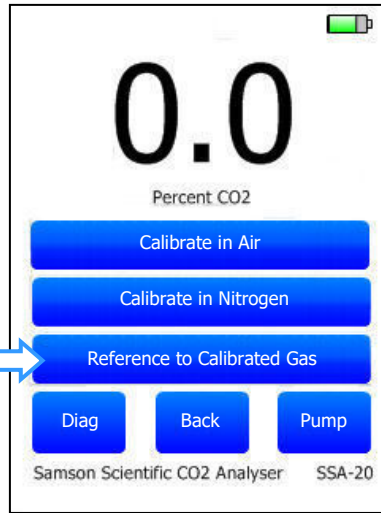

Connect a calibration gas supply with pressure set no higher than 0.3L/min and turn on the supply

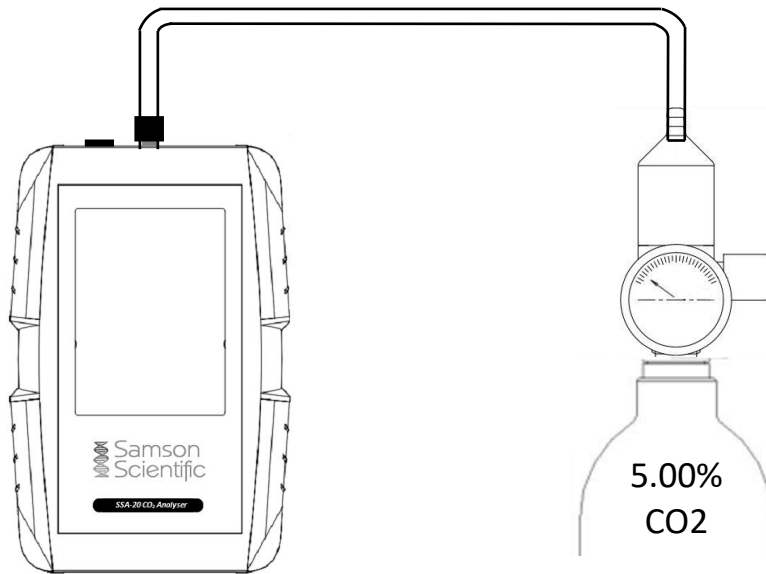

Flow the gas for at least 90 seconds

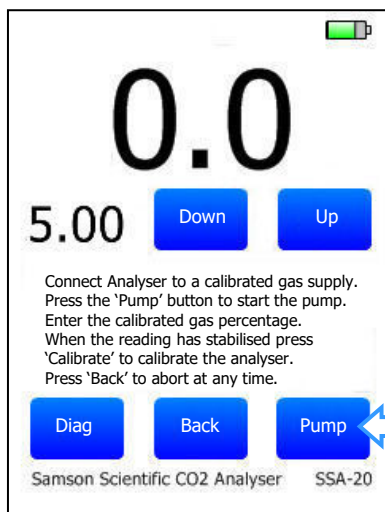

When the reading stabilises press **Calibrate** and the unit will adjust to match the cal gas value

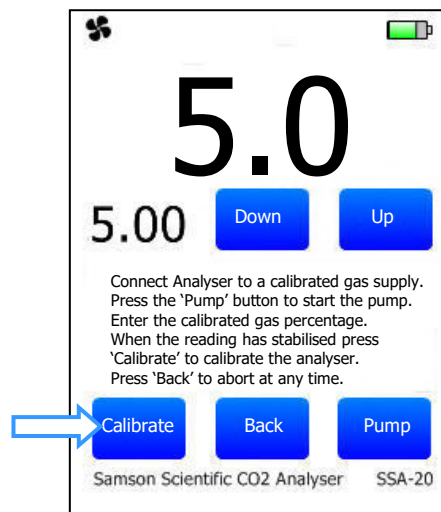

Turn off the gas supply and press the **Pump** button to switch off the pump.
Press the **Back** button three times to return to the home screen.

5. Available Accessories

SSA-20 CO2 Analyser Accessories	Part Number
SSA-20 CO2 Analyser	SSA-20-001
SSA-20+ CO2/O2 Analyser	SSA-20-003
Spare Inlet filter pack (2 filters)	SSA-20-005
Spare length of sample tubing with filter	SSA-20-006
Car charging adapter	SSA-20-007
Spare mains charger kit	SSA-20-008
Annual Calibration (48 hour turn around with new Calibration Certificate issued - Shipping not included)	SSA-20-009
Hard Carry Case	SSA-20-CASE
5% CO2 Calibration Gas Balance Nitrogen (110L disposable cylinder)	SS-312031
Pre-Set 0.3L/min Flow Regulator with Pressure Gauge for use with 110L Cylinder	SS-198840

6. Service, Factory Calibration, Technical Support & Warranty

Servicing

There are no user-serviceable parts inside the SSA-20 CO₂ Analyser.

Unauthorised removal of the rear cover of the unit will invalidate the warranty.

Your SSA-20 CO₂ analyser should be regularly calibration checked - a range of calibration check gases can be supplied by Samson Scientific Ltd and we recommend the analyser is serviced at regular intervals (twelve months).

The inline filter, connecting to the gas inlet port must be replaced when the PTFE membrane becomes contaminated or saturated with moisture.

New filters are available from Samson Scientific.

Getting Technical Support

If you have questions about the use or features of your SSA-20 CO₂ Analyser or have any issue, please call +44(0)845 094 9743 or email enquiries@samsonscientific.com for technical support.

When you call or contact us for support, please include as much information as you can along with the Serial Number of your unit. This will allow us to help you more quickly.

Warranty

Samson Scientific warrants this unit to be free of defects in materials and workmanship for a period of 12 months from the date of purchase.

In the unlikely event that your unit malfunctions, it must be returned to the factory for evaluation.

Samson Scientific's Customer Service Department will detail the correct procedure to return your unit. Upon examination by Samson Scientific, if the unit is found to be defective, it will be repaired or replaced at no charge.

Samson Scientific's WARRANTY does not apply to defects resulting from any action of the purchaser, including but not limited to mishandling, improper interfacing, operation outside of design limits, improper repair, or unauthorized modification.

This WARRANTY is VOID if the unit shows any evidence of having been tampered with or shows evidence of having been damaged as a result of excessive corrosion, current, heat, moisture, vibration, improper specification, misapplication, misuse or other operating conditions outside of Samson Scientific's control.