



User Manual

SLS Lab Basics Tablet Microscope Camera | MIC0115

This manual is written for the SLS Lab Basics Tablet Microscope Camera. To ensure safety and optimal performance, it is strongly recommended that you read this manual thoroughly before use.

For future reference, please keep this manual near your worktable where it can be easily accessed.

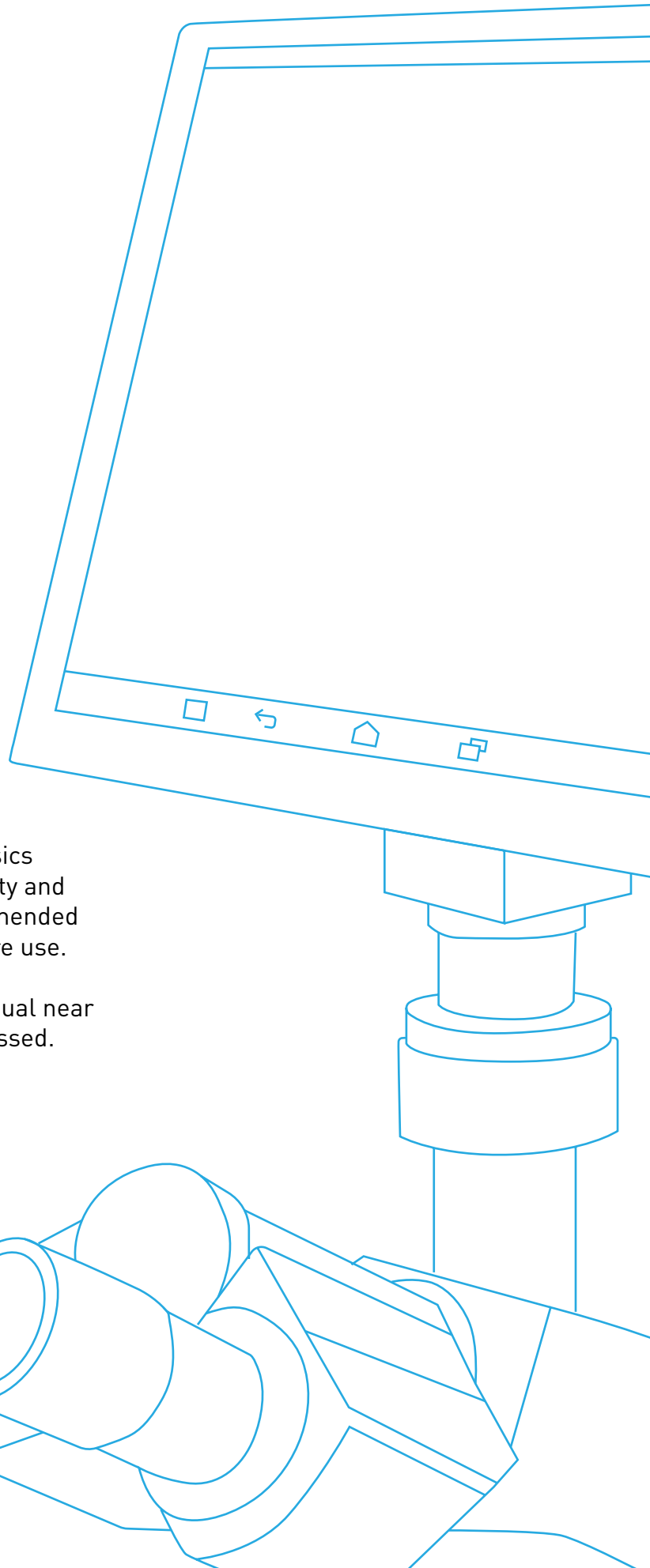

Specification

Spec.	Model	Tablet Microscope Camera (MIC0115)
	Category	All in one Android 5.1 tablet camera
	Sensor	1/2.5"
	Effective pixel	5M
	Screen	9.7", Resolution 2048*1536@15Fps retina screen
	Operation system	Android 5.1.1 version
	Wifi	2.4GHz/5GHz dual bands WIFI support 802.11a/b/g/n/ac protocol
	Bluetooth	Bluetooth 4.0
	Output	USB2.0, HDMI, WIFI, TF card
	Pixel size	2.2 μ m*2.2 μ m
	Power	DC-12V/2A
Function	Basic function	Brightness, Contrast, Saturation, White balance
	Image adjustment	Exposure, Sharpness, Gamma, Colour temperature
	Camera function	Mirror, Flip
	UI interface	Support mouse and touch control
	Image/Video	Support 16M image capture, support 1080P video
	Storage function	Image capture, Video, Preview, SD card formatting
	Labeling function	Point coordinates, cross lines, coordinate systems, text annotations
	Length measurement	Line length, Broken line length, Curve length, Parallel lines distance, Point line distance.
	Geometric measurement	Line length, radius defining circle, two point defining circle, three point defining circle, concentric circles
	The geometric area	Polygon, square
	Measurement system	Built in S-EYE
Package	Size	238.00*51.00*206.00mm
	Weight	0.6kg
	Accessory	DC-12V/2A POWER

Function

1. Connect the DC-12V power
2. Press the ON/OFF button, and the blue light turns on
3. Click S-EYE software

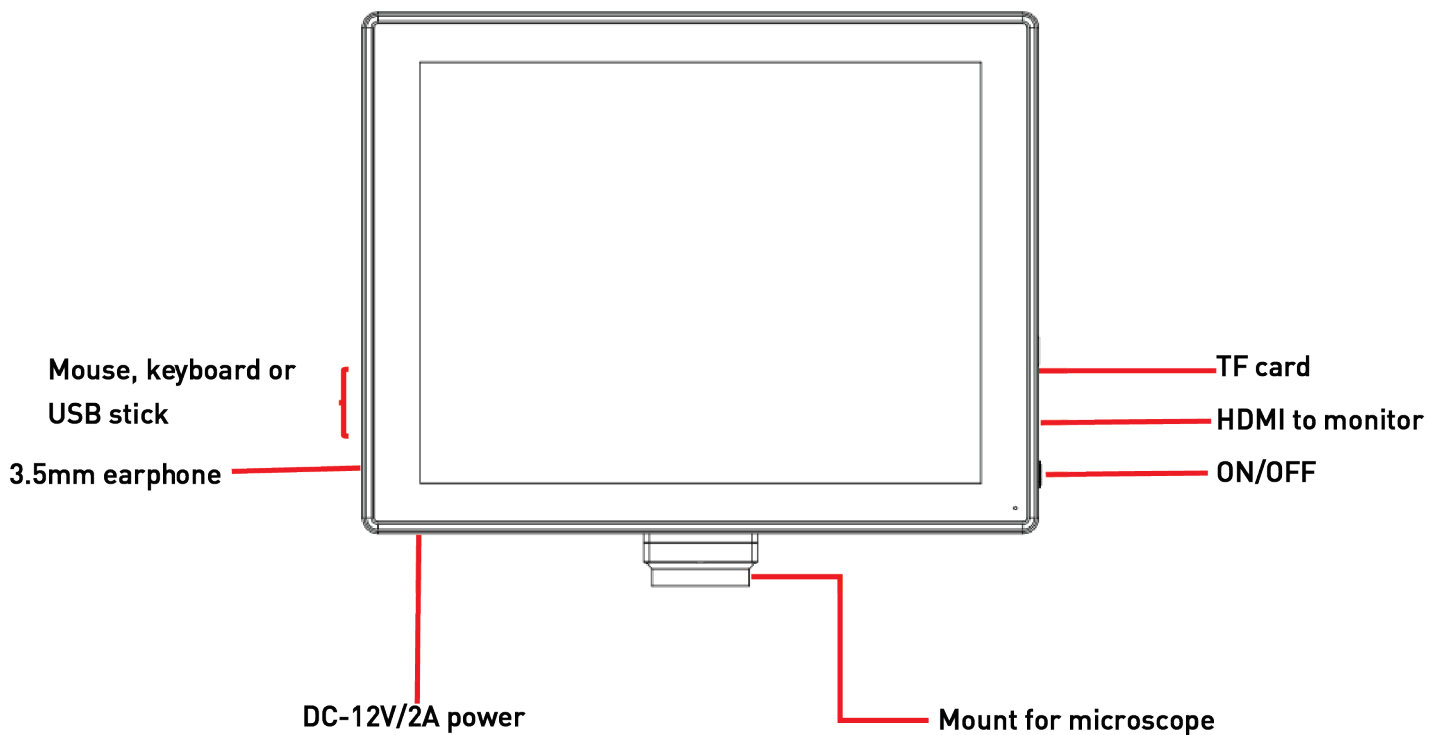

S-EYE

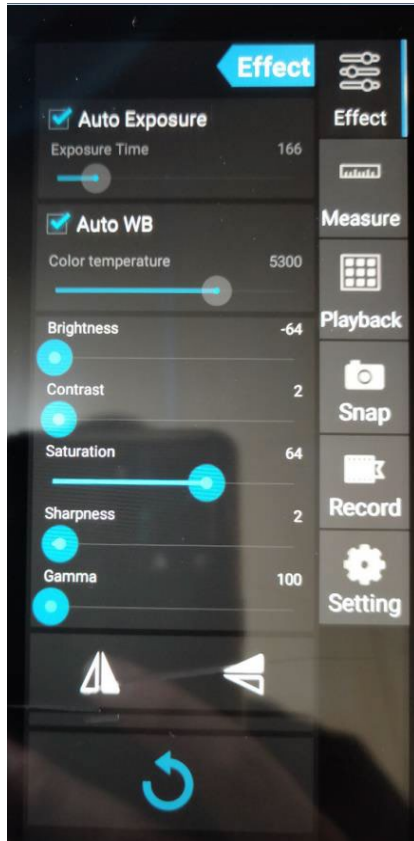

1. Click the Effect and the options will show as left picture.

2. Auto exposure: Tick the auto exposure, and the camera will enter auto exposure mode.

If manual exposure needed, then cancel the check of the auto exposure, and adjust it by the sliding bar.

3. White balance

3.1: Support Auto White balance.

3.2: Can adjust the colour temperature by sliding bar

4. Brightness, Contrast, Saturation, Sharpness, Gamma, adjustment

5. Flip: Vertically or Horizontally flip image



6. Click the reset button, to load saved parameter or factory default.

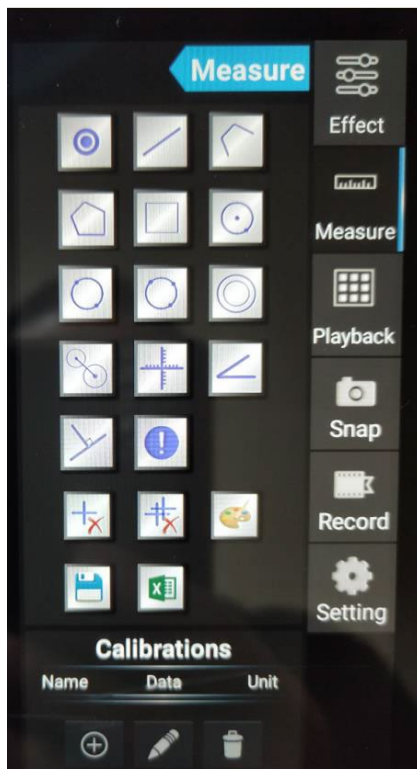

Measurement

Click the Measurement and the menu will show.

See next page for more info on each icon.



Counter point: Click the icon to show a point with incrementing number, used for manually counting.



Line measurement: Can click anywhere on the screen as start point, and click again to determine the distance between the start and end.



Broken line measurement: Click anywhere on the screen as a start, and click again to determine the distance between start and end, and the second point also is the start of the new line. The measurement is the total length.



Polygon: Click anywhere to determine one angle, and it will increase one angle when click each time. Measure the area of the polygon.



Rectangle: Click anywhere on the screen to determine the right-angle, and click again to determine the rectangle area. The result is the rectangle area



Circle: Measure the area of the circle



Concentric circle: Click to determine the centre of the circle at any point in the interface. Secondly, click to determine the distance between the centre of two circles. Thirdly, click to determine the distance between the centre of two circles. Then measuring the radius of the two circles



Two circles measurement: Measure the distance between the centre of two circles.

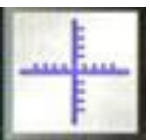

Crosshair: Occur on the image centre, can be dragged



Angle: Click anywhere as a start point, click again to determine the straight line. Click a third time to determine the second line. Measure the angle between two lines.



Vertical line: Click anywhere as a start point, click again to determine the straight line. Click again to determine the vertical distance between point and straight line



Text: After clicking the button, the dialogue box will pop up for annotation



Delete: Delete the selected measuring tool



Delete all: Delete all tools



Tool attributes: Can modify the line colour, line size, and text colour

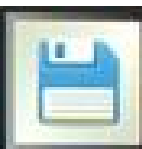

Export image: Export the image with measuring results on it.

Editing Calibrations

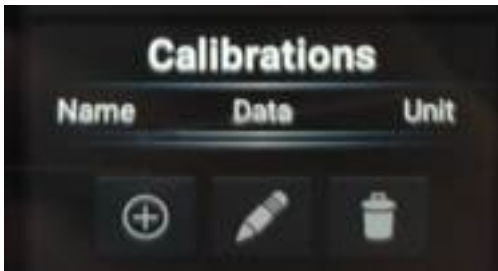

Before measuring, we need to add the calibration based on current microscope magnification and image preview resolution, then we can get the accurate measuring data.

1. Click the “+” to start the calibration

2. Input the corresponding content in the Name option. (When using next time, please make sure that the magnification is same as the one at setting)

3. Use the mouse to drag the yellow ruler, and make it match the physical scale. What we use here is 0.01mm reticle, each is 10 μ m. We take two lattices here, which is 20 μ m

4. Input the number in the Actual length option based on the actual length, and select the length unit.

5. Calibration will calculate the ratio based on the actual length and pixel length.

6. To delete Edited calibration, please click the icon 

7. Input the standard value name and corresponding physical scale actual length, and we input 40X here, it represents the microscope 40 times. There are multiple calibration for selection.

8. Click” Calculate” then calculate actual distance of each pixel under current microscope objective and camera image size, then save it to list. And you can see the 40X in the calibration list.

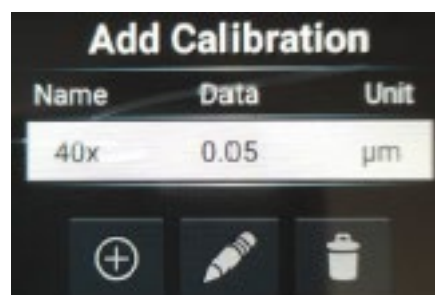
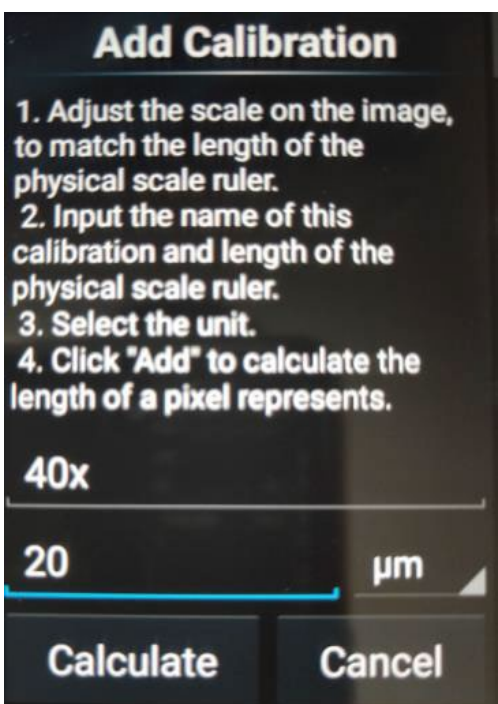
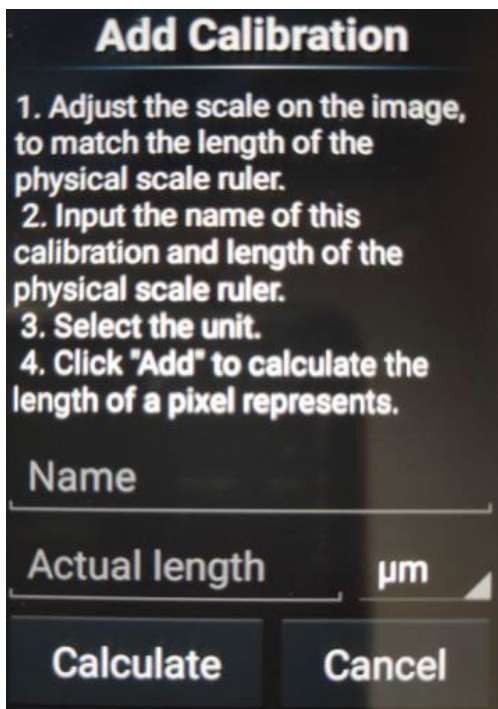



Playback: Display the captured image and video, double click to open the image files.



Snap: Click the icon and capture the image and save it to the device or external USB stick or TF card.



Video: Click icon to start record, and click again to finish record and save the video to the device or external USB stick or TF card. If the preview size is smaller than 1080P, then the video size is same as the preview size. If the preview size is bigger than 1080P, then the video size is lower than 1080P

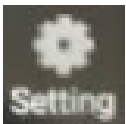

Setting: Adjust the setting of the S-EYE.

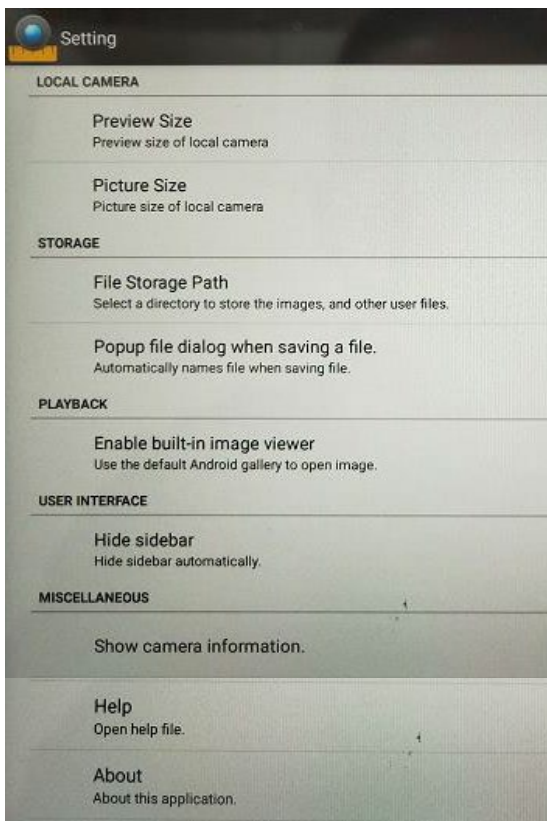

1. **Preview size:** Support 1024*768/1600*1200/2048*1536
2. **Image capture size:** Support 1600*1200/2048*1536/2592*1944/3264*2448/4032*3024/4608*3456
3. **Files saved path:** Can be saved in the device or external TF card or USB stick.
4. When saving files, the file name dialogue will pop up, please set it based on your needs.
5. Activate the internal image view based on your needs.
6. **Hide the sidebar:** Click the sidebar, supports 15 sec./30 sec./1 min/2 min/10 min/never
7. Display camera information based on your needs.
8. **Help:** There are two formats to open Help file- Adobe Reader and WPS Office
9. **About:** Display the S-EYE version and product model number.

Tablet desktop

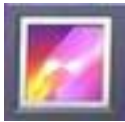
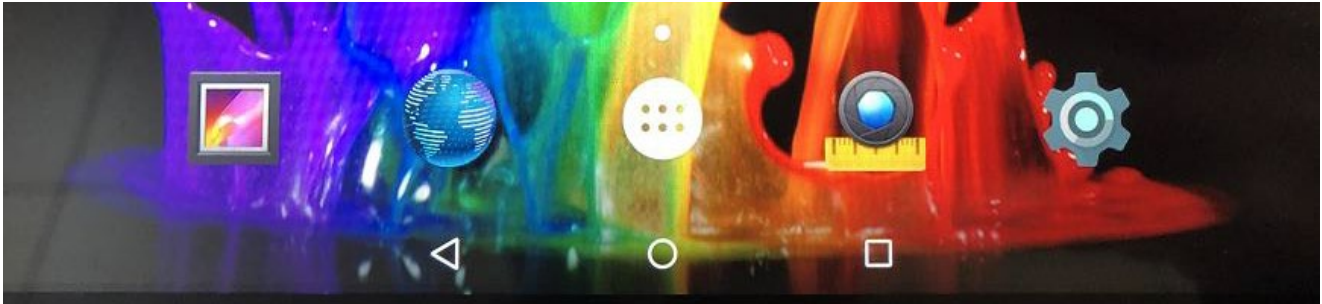

Album: Can check the images



Browser: Support surfing online



Tool bar: Including Calculator / Browser / Recorder / Setting / Video player / Album / Download / Camera/ Music /Explorer/ Adobe Reader/APK installer/S-EYE/WPS Office etc.



S-EYE measurement: Click to enter measurement interface.



Setting: Click to enter setting menu.

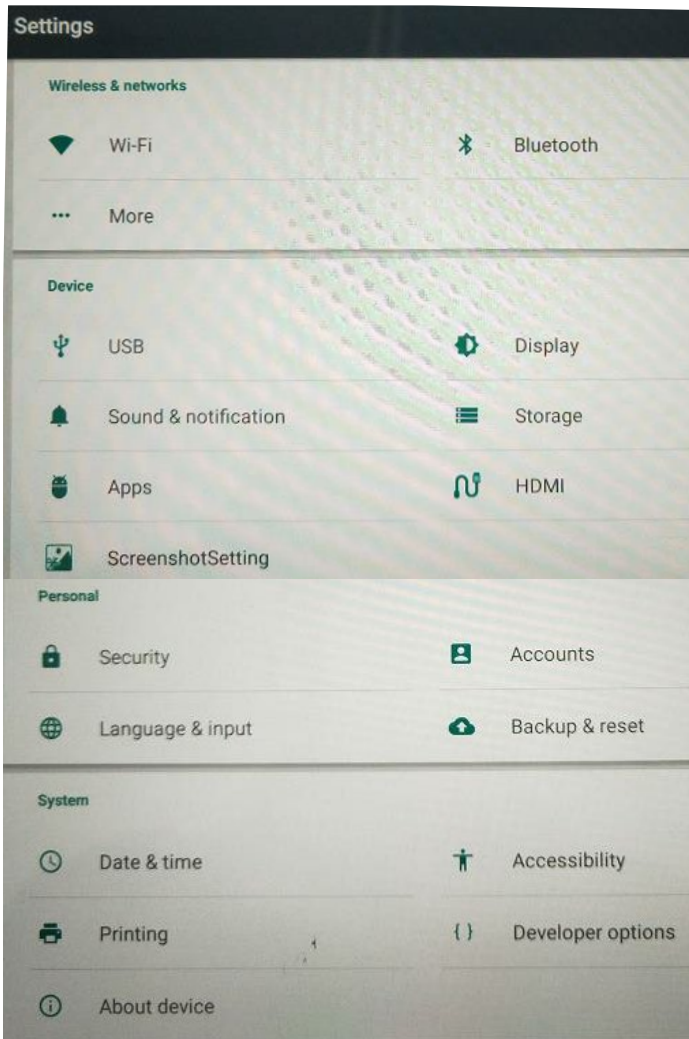

1. WLAN: Click to enter WLAN list. Choose WLAN and input the password to connect the WLAN

2. Bluetooth: Click to activate the Bluetooth.

3. More: Click to choose airplane mode/Share and portable hotspots/VPN

4. USB: If need to connect the PC, please turn on the Connect the PC function.

5. Display: Support to adjust Brightness/Wallpaper/Sleep/Interactive screensaver/Font size/Projecting/screen/Dual screen display.

6. Alert and notice: Support to adjust Media sound/Clock sound/Notice sound/Disturb/phone ring/default phone ring/other alert sound/Lock device (Display or hidden notice.)

7. Storage: Show the internal and external storage information, and support to format external storage device.

8. Application: Click to enter and show the downloaded app.

Image Analysis

Image is an app to analyse micro image on the Android device. It uses OpenCV and help user to improve work efficiency.

Current Image 1.0 version provides Image gradation conversion/Contrast/Brightness adjustment/ Binarization/ Automatic particle counter.

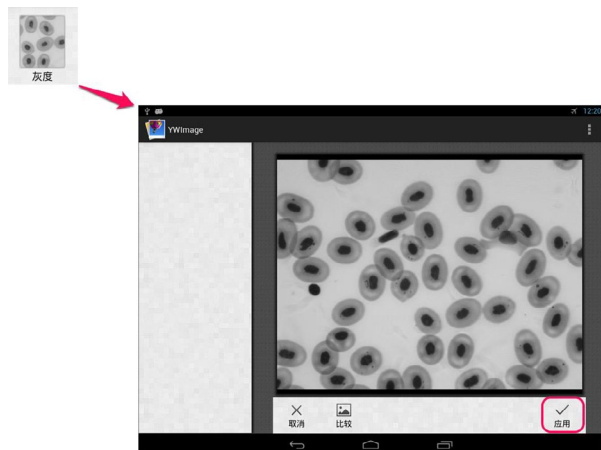

FIGURE 2

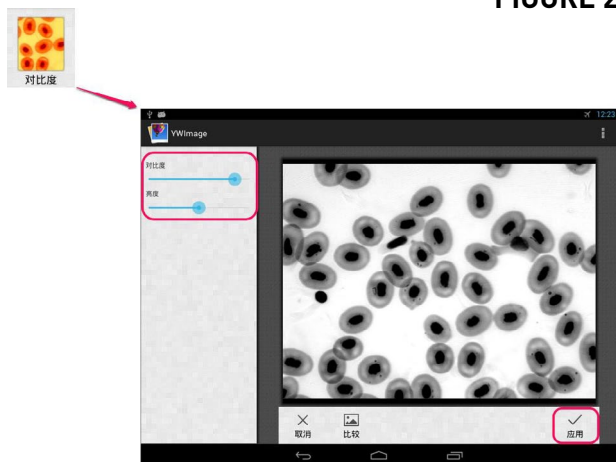

FIGURE 3



FIGURE 4

Particle counter example:

1. Image loading

1.1: Open camera setting, tick Activate image analysis.

1.2: Image can choose the existed picture or get picture by the camera app.

Click the upper right Camera button to choose and load the image.

1.3: Click the Playback button and double click to load the image.

2. Change the image to Grayscale (FIGURE 2)

Click the Grayscale button on the left, and change the image to grayscale, and click Apply to confirm it

3. Adjust Contrast and Brightness (FIGURE 3)

Adjust the contrast and brightness of Grayscale image, make the particle and background as different as possible.

4. Binarization (FIGURE 4)

Use the binarization tool to adjust the Max and min value of Threshold Range. In the example, we set the threshold area at 0 start area. Then the black pixel of the image is set to red. After binarization, the red area pixel will set to 0, and other area will set to 255.

5. Particle counter

After image binarization, open the Particle counter tool

First, please set the particle area range. Because of the impurity or image quality problem, the image after binarization will have black area that without particle, please set the area Min value bigger.

Sometimes the image border already will be seen as particle, hence need to set the Max value of area range.

If needs to get back to unlimited, please click icon 

“Show border” support to show data and particle border or not after particle counting.

Click “Particle analysis”, and the particle serial number and area will show



面积范围 (Pixel²)

80 ~ 2000 

显示边框

颗粒分析

Sum: 42
Min: 0.0
Max: 1203.5

序号	面积
0	1189.0
1	1152.5
2	1012.5
3	1060.0
4	1017.0
5	1053.5
6	1131.0
7	878.0
8	936.5
9	978.0
10	1013.5
11	1019.5
12	926.0
13	858.0
14	962.5
15	988.5

CSV

取消 比较 应用

Click “CSV” button, and the data will be saved to CSV format, the default path is:
/mnt/sdcard/Image/Reports



User Manual
SLS Lab Basics Tablet
Microscope Camera | MIC0115

Brought to you by



Scientific Laboratory Supplies
Unit 6 Fairham Business Park
Foresters Avenue
Fairham
Nottingham
NG11 2AF

Tel: +44(0) 115 982 1111
slsinfo@scientific-labs.com
www.scientificlabs.co.uk