



HI6421  
**Advanced Dissolved Oxygen  
Benchtop Meter**

## Dear Customer,

Thank you for choosing a Hanna Instruments® product.

Please read this instruction manual carefully before using this instrument as it provides the necessary information for correct use of this instrument, as well as a precise idea of its versatility.

If you need additional technical information, do not hesitate to e-mail us at [tech@hannainst.com](mailto:tech@hannainst.com).

Visit [www.hannainst.com](http://www.hannainst.com) for more information about Hanna Instruments and our products.

## TABLE OF CONTENTS

1. Preliminary Examination .....	3	9.4. View .....	42
2. Safety Measures .....	3	9.5. Alarms .....	45
3. User Interface – Icons .....	4	9.6. Logging .....	46
4. General Description & Intended Use .....	6	9.7. Profiles .....	47
4.1. Main Features .....	7	10. Calibration .....	48
5. Specifications .....	8	10.1. Probe Preparation .....	48
5.1. Instrument .....	8	10.2. DO Calibration .....	50
5.2. Optical Probe (HI7641133) .....	10	10.3. Pressure Compensation .....	52
5.3. Polarographic Probe (HI764833) .....	11	10.4. Salinity Compensation .....	52
6. Functional & LCD Description .....	12	11. Measurement .....	52
6.1. Main Unit .....	12	11.1. Guidelines .....	52
6.2. Probes .....	14	11.2. Measurement Tips .....	53
7. Getting Started .....	15	11.3. Direct Readings .....	53
7.1. Attaching the Holder .....	15	11.4. Direct/Autohold Readings .....	54
7.2. Using the Adapter .....	16	12. Logging .....	54
7.3. Using the Holder .....	18	12.1. Automatic Logging .....	55
7.4. Connecting the Probe, Keyboard, Printer .....	18	12.2. Manual Logging .....	56
7.5. Powering the Unit, Selecting Operating Language and Regional Preferences .....	19	12.3. Autohold Logging .....	57
7.6. Basic Operations .....	19	13. Maintenance .....	58
8. System Menu Items .....	20	13.1. Benchtop General Cleaning .....	58
8.1. Users .....	20	13.2. Optical Probe (HI7641133) .....	58
8.2. System Settings .....	24	13.3. Polarographic Probe (HI764833) .....	60
8.3. Measurement Settings .....	30	14. Error Messages .....	61
8.4. Log Recall .....	31	16. Abbreviations .....	62
8.5. Help .....	38	17. Accessories .....	62
9. Measurement & Probe Setup Menu .....	39	Certification .....	63
9.1. Calibration .....	39	Recommendations for Users .....	63
9.2. Reading .....	40	Warranty .....	63
9.3. Temperature .....	41	Regulatory Notices for the Wi-Fi Module .....	64

*All rights are reserved. Reproduction in whole or in part is prohibited without the written consent of the copyright owner, Hanna Instruments Inc., Woonsocket, Rhode Island, 02895, USA. Hanna Instruments reserves the right to modify the design, construction, or appearance of its products without advance notice.*

## 1. PRELIMINARY EXAMINATION

HI6421 is an advanced dissolved oxygen benchtop meter with a large touchscreen display and streamlined design. HI6421 is delivered with either an optical dissolved oxygen probe (HI7641133) or a polarographic probe (HI764833).

### Benchtop models

HI6421-01 US power plug

HI6421-02 EU power plug

### Package contents

Ordering code **HI6421** is delivered with:

- HI7641133 optical DO probe (opdo<sup>®</sup>)
- HI764113-1 Smart Cap<sup>™</sup> with O-ring
- Calibration/storage vessel
- Syringe, lens wipe, silicone grease (6 g sachet)
- DO Smart Cap quality certificate

Ordering code **HI6421P** is delivered with:

- HI764833 polarographic DO probe
- Membrane cap with O-ring (2 pcs.)
- HI7041S Electrolyte solution (30 mL)

Additionally, **both** ordering codes are delivered with:

- HI764060 electrode holder with following accessories:
  - base plate (integrated pivot pin) and screw, requires installation
  - cable holder clip, attached
  - electrode holder with adapter, attached
- 24 VDC power adapter
- USB-C to USB-A cable
- Probe quality certificate
- Instrument quality certificate
- Quick reference guide



















**Note:** Save all packing material until you are sure the instrument works correctly. Any damaged or defective item must be returned in its original packing material with the supplied accessories.









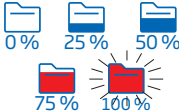













## 2. HANDLING AND USAGE PRECAUTIONS

The unit, while not fragile, can be damaged by improper handling and usage.

- Transport the unit with all cables removed.
- Keep the unit on a stable and even surface, away from contact with liquid.
- Avoid excessive dirt and dust.
- Protect the unit from contact with food, oils, and chemicals.
- If the device becomes wet, gently wipe the exterior with a clean, dry cloth.
- Keep away from direct sunlight.
- Use in a safe place that is appropriate to application requirements.
- Use attachments and accessories specified in this manual only.
- Capacitive touchscreen and buttons — operate without applying pressure.
- Do not puncture the capacitive touchscreen or drop the unit.
- Do not use the device near heat sources.
- Do not place objects on top of the device.
- Do not insert objects into the ports, spaces around keys, other than the intended cable, USB drive.

### 3. USER INTERFACE – ICONS

Capacitive keys	Description
	<b>Back</b> – return to a previous hierarchical menu level
	<b>Home</b> – access to measurement screen & configured profile
	<b>Menu</b> – access to Users, System Settings, Measurement Settings, Log Recall, Help
Main menu	Description
	Users – user configuration & login
	System Settings – system configuration, connectivity & printing items
	Measurement Settings
	Log Recall – access logged measurement data
	Help – access support
Measurement	Description
	Measurement Menu, accessed from measurement screen
	opdo <sup>®</sup> probe
	Polarographic probe
	Autohold applied
	Autohold, waiting stable DO measurement
	Warning on standby/ active function
Logging	Description
	Start/ Stop logging (current index and time since log started)
	Manual logging (current index)
	Triggers log session, pending next stable measurement
	Autohold logging in progress
	Annotated text/Annotated text in use
	Available storage capacity (at full capacity the icon displayed blinking)

		Description
Log recall		Table view, function active/not selected
		Table view, function active/not selected
		Graph view, function active/not selected
		Graph view, function active/not selected
		Information view, function active/not selected
		Information view, function active/not selected
<hr/>		
General		Description
		Profile
		Background operation in progress
		Alarm enabled
		Stability/Autohold indicator
<hr/>		
Connectivity & Printing		Description
Ethernet		Connection established (tap for IP address)
		Connection in progress
		Connection error
Wi-Fi		Connection established (tap for IP address)
		Connection in progress
		Connection error
USB		USB-A or USB-C flash drive plugged in
		High-power consumption with the flash drive plugged in
PC		PC connection established through USB-C port
Printer		Printer connected - printing manual log option <b>enabled</b>
		Printer connected - printing manual log option <b>disabled</b>
		Printer not recognized or no longer connected

## 4. GENERAL DESCRIPTION & INTENDED USE

**HI6421** is an advanced benchtop meter with a capacitive display, comprised of a housing and an integrated dissolved oxygen (DO) measurement module.

Compact and easy to operate, **HI6421** is delivered either with **HI7641133** optical dissolved oxygen (opdo<sup>®</sup>) probe or **HI764833** polarographic probe. When delivered with polarographic probe meter ordering code is **HI6421P**.

Designed for fresh and saltwater measurements of dissolved oxygen, the system responds to a complex range of measurement and monitoring requirements, providing accuracy, reproducibility, and reliability.

**HI7641133** optical DO probe (with **HI764113-1** Smart Cap) provides accurate DO measurements over long periods of time reducing the need for frequent calibration. The Smart Cap, pre-loaded with calibration coefficients, includes the immobilized O<sub>2</sub> sensitive luminophore with rugged, insoluble black oxygen permeable protective layer.

The principle of operation is based on the principle of fluorescence quenching and features an immobilized Pt-based luminophore that is excited by the light of a blue LED and emits a red light. Dissolved oxygen quenches this excitation. When there is no oxygen present, the lifetime of the signal is the greatest; as oxygen hits the sensing surface, the lifetime becomes shorter.

The intensity and lifetime are inversely proportional to the amount of oxygen present; as oxygen interacts with the luminophore it reduces the intensity and lifetime of the luminescence. The lifetime of the luminescence is measured by a photodetector, and is used to calculate the dissolved oxygen concentration. This is, in turn, reported by the meter as % saturation or mg/L of dissolved oxygen.

**HI764833** polarographic probe features a platinum cathode and Ag/AgCl anode assembly, and a built-in temperature sensor that compensates for temperature variations. The probe is fitted with a PTFE screw cap membrane that separates the probe's cathode and anode from the sample being measured. Oxygen diffuses across the membrane and interacts with the polarographic system to produce a current proportional to oxygen concentration. The cap is filled with **HI7041** electrolyte and screwed on to the probe.

Probe connection to the unit is secured through a DIN connector.

The meter is supplied with an electrode holder that has a flexible arm. The holder can be mounted quickly and provides secure support for electrodes while taking measurements in sample containers.

This benchtop meter supports:

- USB type A – support for USB drive, printer (standard or thermal), keyboard
- USB type C – support for USB drive, PC connection

The user can select between five different views.

- Basic measurement configuration
- Simple GLP with calibration information
- Full GLP with probe status and calibration details
- Live updated, interactive graph
- Tabulated data with date, time, and notes

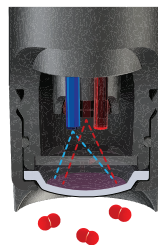

## Capacitive touchscreen with multi-touch support

The benchtop unit has a 7-inch color display with  $800 \times 480$ p resolution. The capacitive, multi-touch screen supports video playback and data plotting.

### 4.1. MAIN FEATURES

#### Measurement & Calibration

- Measure DO expressed as:
  - > %Sat
  - > mg/L
  - > ppm
- Application-specific profiles allow quick and direct measurement without the need to update the sensor and system settings
- Active log during measurement
- Measurement stability indicator (using the Stability Criteria setting)
- Reading modes: direct and direct/autohold
- Temperature compensation can be Automatic (using integral temperature sensor within probe) or set manually
- Audible and/or alarm messages for measurements outside predefined limits
- Automatic or Manual assigned standards for calibration
- One or two points automatic calibration at 100.0 % (8.26 mg/L) and 0.0 % (0.00 mg/L)
- Single point manual calibration using a value entered by the user in % saturation or mg/L
- Non-volatile memory for data storage and settings

#### Logging

- Data log collection of at least 1 000 000 data points (with time and date stamp)
- Logging types: manual, automatic, autohold
- Sample ID for manual and autohold data

#### Connectivity features & services

- Transfer logged data to a USB thumb drive
- Log files include measurements and calibration data (as .CSV file)
- FTP and email for log export via Ethernet and Wi-Fi connection
- Download logs using the benchtop's embedded web server
- USB type A for USB drive, printer, and keyboard
- USB type C for USB drive and PC connection

#### User-support feature

- Help section — brief overview of instrument's main functions and features

## 5. SPECIFICATIONS

### 5.1. INSTRUMENT

DO*	Range	0.0 to 600.0 % saturation 0.00 to 90.00 mg/L (ppm) concentration
	Resolution	0.1 % saturation 0.01 mg/L (ppm)
	Accuracy	Refer to probe used
DO calibration	Points	One or two points at 100.0 % (8.26 mg/L) and 0.0 % (0.00 mg/L)
	Type	Automatic Manual (user entered value in % saturation, mg/L, or ppm)
	Reminder	Daily: 0 min. to 23 hours and 59 min. Periodic: 1 min. to 30 days, 23 hours and 59 min. Disabled
Views	Basic	Measurement <ul style="list-style-type: none"> <li>&gt; DO</li> <li>&gt; Pressure</li> <li>&gt; Temperature (ATC or MTC)</li> </ul> Stability status
	Simple GLP	Basic view information DO last calibration date, barometric pressure, offset, average slope
	Full GLP	Simple GLP information and calibration point details
	Table	Measurements updated every second are displayed in table. With Manual logging type, configuration displays table of logged data points.
	Graph (Plot)	DO and temperature versus time (pinch-to-zoom for graph pan or zoom)
Barometric pressure	Range	450.0 to 850.0 mmHg / 600.0 to 1133.2 mbar / 60.00 to 113.32 kPa 17.72 to 33.46 inHg / 8.702 to 16.436 psi / 0.5921 to 1.1184 atm
	Resolution	0.1 mmHg / 0.1 mBar / 0.01 kPa / 0.01 inHg / 0.001 psi / 0.0001 atm
	Accuracy	$\pm 3$ mmHg within $\pm 15$ % from the calibration point $\pm 3$ mmHg $\pm 1$ , least significant digit
	Compensation	Automatic (meter-integrated barometer) Manual

\* Consider probe's limits



Temperature*	Range	—20.0 to 120.0 °C; —4.0 to 248.0 °F; 253.2 to 393.2 K	
	Resolution	0.1 °C / 0.1 °F / 0.1 K	
	Accuracy	Refer to probe used	
	Compensation	Automatic or Manual	
Temperature user calibration		1 point, configurable	
Salinity	Compensation	Manual > 0.00 to 45.00 psu or ppt > 0.0 to 130.0 ‰	
Logging	Type	Automatic Manual Autohold	
	Number of records	50 000 maximum per file Stores at least 1 000 000 data points per user	
	Automatic interval	1, 2, 5, 10, 30 seconds 1, 2, 5, 10, 15, 30, 60, 120, 150, 180 minutes	
	Sample ID	Incremental mode	
	Export option	.CSV file format	
Users		Up to 9 users and the default administrator account	
Connectivity	USB-A	2 ports for keyboard and/or printer input or USB flash drive	
	USB-C	1 port for PC connectivity and USB-C type flash drive	
	Wi-Fi & Ethernet	FTP Web server Email	Log transfer and download
	RS232	Connecting peripherals	
Power supply		DC adapter 100-240 VAC to 24 VDC 2 A	
Environment		0 - 50 °C / 32 - 122 °F / 273 - 323 K, maximum 95 % RH non-condensing	
Dimensions		205 × 160 × 77 mm (8.0 × 6.2 × 3.0")	
Weight		Approximately 1.2 kg (26.5 lbs.)	

\* Consider probe's limits

## 5.2. OPTICAL PROBE (HI7641133)

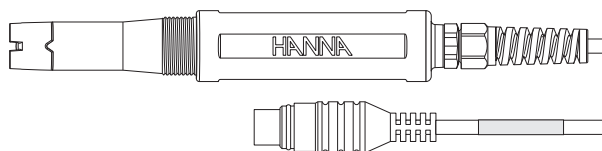

Dissolved Oxygen	Range	0.0 to 500.0 % saturation 0.00 to 90.00 mg/L (ppm) concentration	
	Resolution	0.1 % saturation 0.01 mg/L (ppm)	
	Accuracy	± 1.5 % of reading ± 0.01 mg/L (ppm) for 0.00 to 20.00 mg/L (ppm) ± 5 % of reading for 20.00 to 50.00 mg/L (ppm) ± 1.5 % of reading ± 0.1 % for 0.0 to 200.0 % saturation ± 5 % of reading for 200.0 to 500.0 % saturation	
Temperature	Range	− 5.0 to 50.0 °C / 23.0 to 122.0 °F / 268.2 to 323.2 K	
	Resolution	0.1 °C / 0.1 °F / 0.1 K	
	Accuracy	± 0.3 °C / ± 0.4 °F / ± 0.2 K	
Sensor type	Optical		
Wetted parts	Body material	ABS	
	Smart Cap	Polypropylene + PMMA (dome-shaped membrane)	
	O-ring	NBR	
	Temperature contact	Stainless steel	
Cable	1 m (3.3') PVC jacket		
Dimensions	Ø 17 mm (0.67")		

### 5.3. POLAROGRAPHIC PROBE (HI764833)

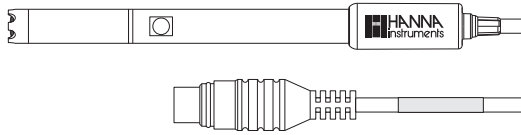

Dissolved Oxygen	Range	0.0 to 300.0 % saturation 0.00 to 45.00 mg/L (ppm) concentration	
	Resolution	0.1 % saturation 0.01 mg/L (ppm)	
	Accuracy	$\pm 1.5$ % of reading $\pm 1$ , least significant digit	
Temperature	Range	0.0 to 50.0 °C / 32.0 to 122.0 °F / 273.2 to 323.2 K	
	Resolution	0.1 °C / 0.1 °F / 0.1 K	
	Accuracy	$\pm 0.2$ °C / $\pm 0.4$ °F / $\pm 0.2$ K	
Sensor type	Polarographic		
Wetted parts	Body material	PEI	
	Membrane cap	PEI + PTFE membrane	
	O-ring	NBR	
	Temperature contact	Stainless steel	
Cable	1 m (3.3') PVC jacket		
Dimensions	$\varnothing$ 12 mm (0.47")		

## 6. FUNCTIONAL & LCD DESCRIPTION

### 6.1. MAIN UNIT

#### Front View

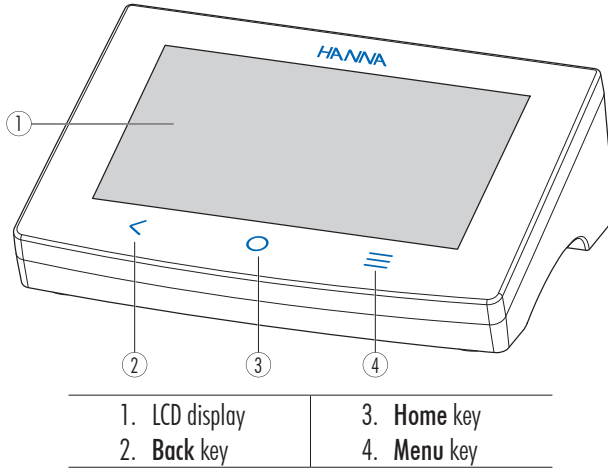

#### LCD Description

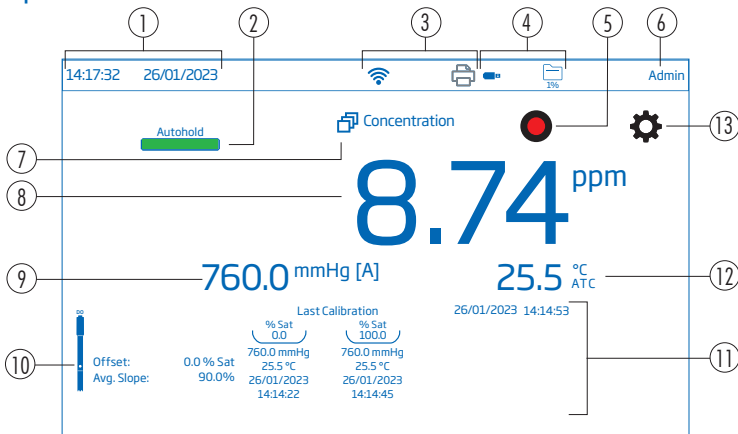

1. Current time and date
2. Stability indicator
3. Connectivity and Printer icons
4. USB connection status and logging space availability
5. Start Logging icon
6. User name (default "Admin")
7. Profile in use

8. DO reading
9. Pressure reading
10. DO probe icon
11. Calibration information
12. Temperature reading and temperature compensation status
13. Measurement Settings icon

## Status Area



Continuously displayed after powering the unit, status area runs horizontally across the top of the LCD screen.

- Top left – current time & date
- Middle – connectivity status
- Top right – storage space availability & username

## Direct keys

Icon	Name	Function
<	Back	<ul style="list-style-type: none"> <li>• returns user to previous hierarchical menu level</li> <li>• exit or escape function</li> </ul>
○	Home	<ul style="list-style-type: none"> <li>• access to measurement screen</li> <li>• exit or escape function</li> </ul>
≡	Menu	<ul style="list-style-type: none"> <li>• access to Users, System Settings, Measurement Settings, Log Recall, Help</li> </ul>

## Rear view

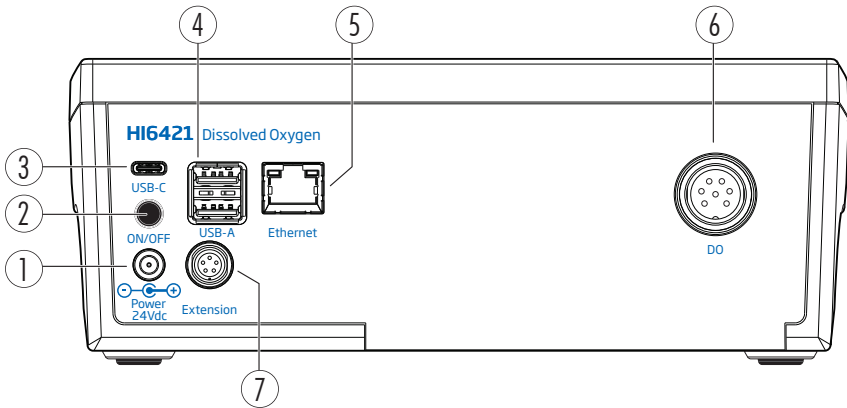

1. Input for power cable
2. Power button
3. Input for USB-C flash or PC cable
4. Input for USB-A flash (x2) or keyboard
5. Ethernet port
6. Dissolved Oxygen probe DIN connection port
7. Peripherals port

6.2. PROBES

HI7641133 Optical Probe

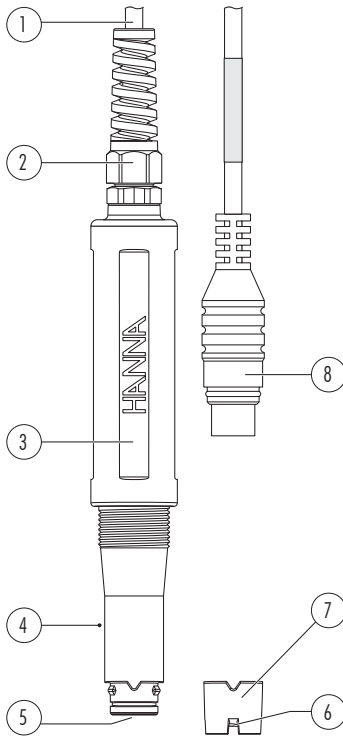

1. Cable
2. Cable relief
3. Probe body
4. Temperature sensor
5. Optical window
6. Embedded O<sub>2</sub> sensitive luminophore with oxygen-permeable black protective layer
7. Smart Cap
8. DIN Connector

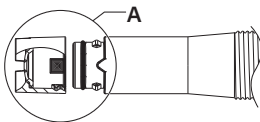

DETAIL A

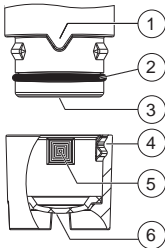

1. Alignment key
2. O-ring seal
3. Optical window
4. Smart Cap
5. Data storage tag
6. Embedded O<sub>2</sub> sensitive luminophore with oxygen-permeable black protective layer

## HI764833 Polarographic Probe

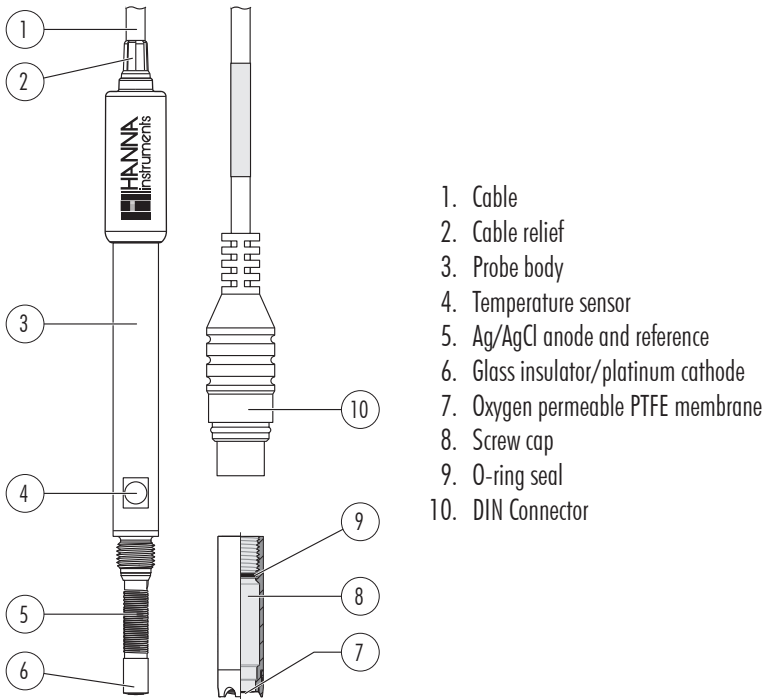

1. Cable
2. Cable relief
3. Probe body
4. Temperature sensor
5. Ag/AgCl anode and reference
6. Glass insulator/platinum cathode
7. Oxygen permeable PTFE membrane
8. Screw cap
9. O-ring seal
10. DIN Connector

The **HI76483** Clark-Type Polarographic probe has a thin, 12 mm (0.47") design that allows for convenient measurement in narrow vessels such as test tubes, wine bottles, and Biological Oxygen Demand (BOD) bottles. Screw-on caps with pretensioned membranes provide quick maintenance.

## 7. GETTING STARTED

### 7.1. ATTACHING THE HOLDER

#### Attaching the electrode holder base plate

- Take the **HI764060** holder from the box.
- Identify the metal base plate (4) with the integrated pivot pin (5) and the screw (2).
- The plate may be attached to either side of the meter, left (L) or right (R).
- Place the meter face down on a clean, dry surface.
- Align the hole on the base plate (3) over the rubber foot (6R or 6L).

The pivot pin (5) should be facing downward.

- Use a screwdriver (1) to tighten the screw (2) and attach the base plate to the meter.
- Position the meter with the display facing up.
- Slide the holder (7) over the pivot pin (5). A "slide in" motion is required to lock the arm into position.
- For increased arm rigidity, tighten the metal knobs on both sides of the holder.

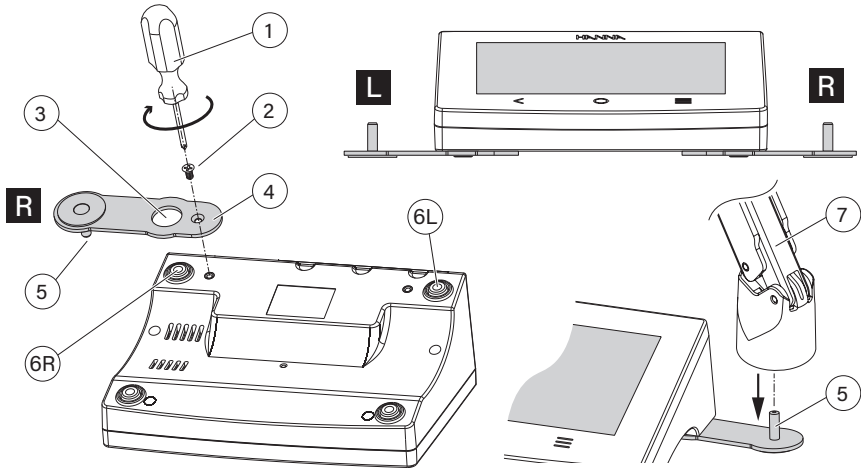

**Cable holder clip**

The holder is delivered with a cable holder clip (attached) that secures several cables whilst allowing them to move freely with the arm motion.

1. To open the latch, press the clip inward while pulling up the latch.
2. To close the latch, lower latch over cable and snap closed.

The latch snaps in position and secures the cables inside.

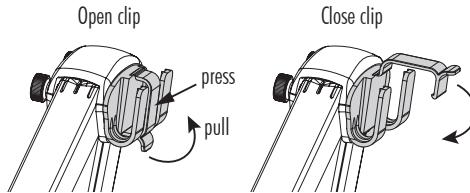

To reattach the clip onto the electrode arm:

1. Align the clip's dovetail over the slot.
2. Gently push down to slide in position.

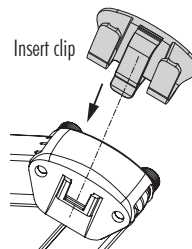

**7.2. USING THE ADAPTER**

The electrode arm is ended with an electrode holder. The holder is fitted with an adapter that has two different-sized apertures:

- center-back (optical and polarographic probe, with adapter only)
- left and right (polarographic probe only)



## Using the Optical Probe

1. Squeeze to depress the two locking wings. Push the adapter up to remove.
2. Align the flat surface on the probe with the snap fit guides on the adapter.
3. Push the probe in.
4. Insert the adapter (and probe) slowly into the electrode holder keeping the positioning marks on the adapter and holder aligned with each other.
5. Push (light to moderate pressure) the adapter down until it securely clicks in place.
6. Clip the cables through the top-entry cable clip.

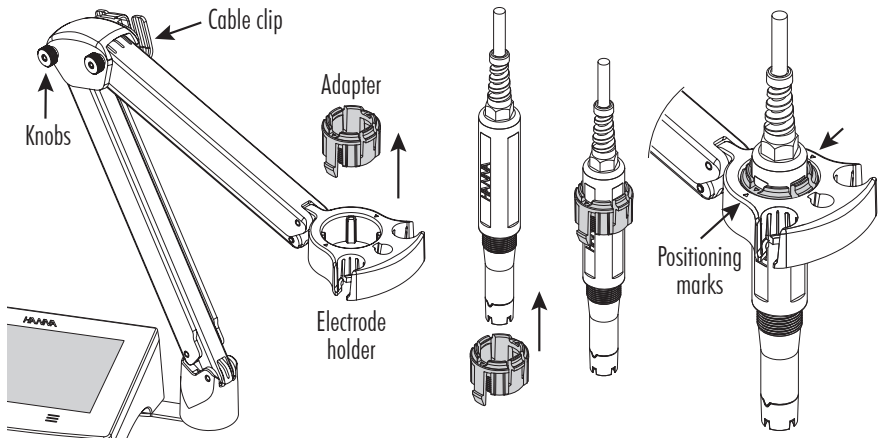

**Notes:** Do not use excessive force to insert the adapter. If there is resistance, re-check that the positioning marks are correctly aligned.

## Using the Polarographic Probe

Use the fitted adapter for probe's center back positioning.  
The two side holes allow for probe's left or right positioning.

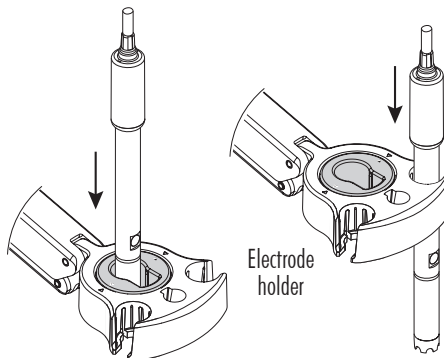

### 7.3. USING THE HOLDER

Use the holder for probe support and easy movement in and out of beakers and containers during calibration and sample measurement.

### 7.4. CONNECTING THE PROBE, KEYBOARD, PRINTER

#### Connecting the probe

The DO probes are connected to the meter through a DIN connector, which makes attaching and removing the probe an easy process. When connected, the probe is automatically detected. With the meter off:

- Connect the probe to the DIN connection port, on the back of the meter.
- Align the pins and key then push the plug into the socket.

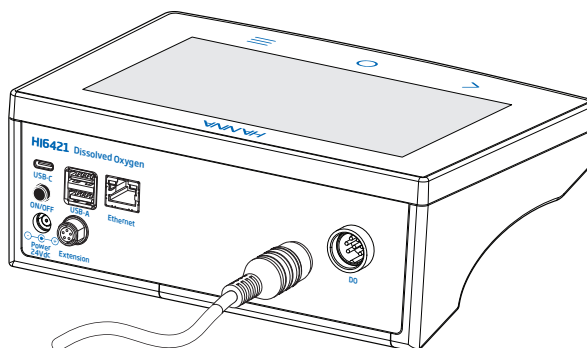

**Note:** The probe must be correctly plugged in for the system to work correctly.

#### Connecting a USB-A keyboard

Connect a USB's keyboard plug into the USB-A input on the back of the unit. Once connected the keyboard is automatically detected.

Users can attach a keyboard to set up user password, user and company information, and sample information such as company or lab name.

#### Connecting a printer (standard or thermal)

Hanna<sup>®</sup> aims to ensure meter compatibility with USB printers but can not ensure compatibility with all models. HI6421 can print directly to certain models of USB-dedicated printers with PCL printer language capability.

#### Printer components and requirements

- Printer, PCL driver compatible
- Cable
  - ▶ power cable
  - ▶ USB connector cable with two ends:
    - type B connector (plugs into printer)
    - type A connector (plugs into the USB port on the meter)

**Note:** ensure meter is correctly plugged in to power supply.

## 7.5. POWERING THE UNIT, SELECTING OPERATING LANGUAGE AND REGIONAL PREFERENCES

1. Connect the power adapter (included) to 24 V power socket located on rear panel of meter.
2. Connect power adapter to wall outlet.
3. Press the black ON/OFF power button.

At start up, the meter briefly displays the initialization screen.

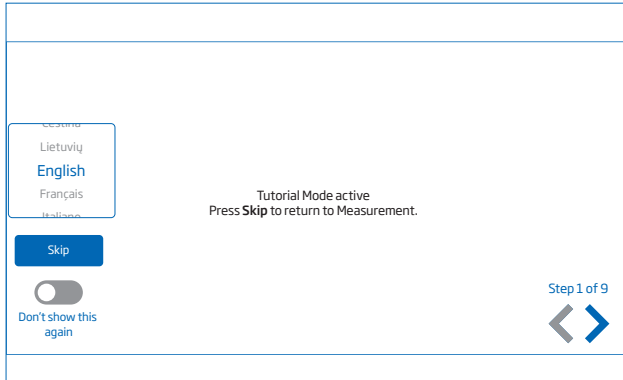

4. The instrument launches into a Tutorial.

Tap  to automatically enter measurement screen.



At first power up the default language is English. A language window allows users to set operating language.









### Configure regional preferences

- Tap  (direct **Menu** key) to access System Settings screen.
- Tap  (System Settings icon) and select **System** tab.

Users can change the date, time, and region settings, as well as language preference.

## 7.6. BASIC OPERATIONS

General operating modes are setup, measurement, logging, and data sharing.

- Tap  (**Menu** key) to access:
  -  Users
  -  System Settings
  -  Measurement Settings
  -  Log Recall
  -  Help
- Tap  (**Home** key) to return to measurement.
- Tap  (Measurement Menu icon) to access sensor-related functions.



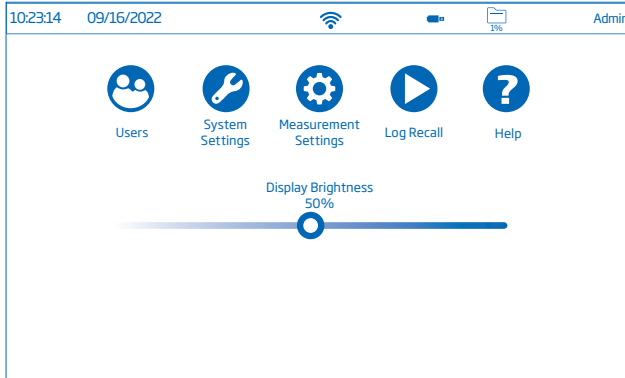

## 8. SYSTEM MENU ITEMS

Tap  (Menu key) to access System Menu screen.

*Note: Once multiple users are set up users must have previously logged in to access System Menu.*



### System Menu capacitive icons

Symbol	Name	Function
	Users	Administrator operations and user setup User information and password
	System Settings	Network, connectivity, printing and System configuration
	Measurement Settings	Measurement configuration
	Log Recall	Access logged measurement data and manage files
	Help	Access video-supported outline of main instrument functions

### Brightness control bar



Drag the slider along the control bar to adjust brightness.

### 8.1. USERS



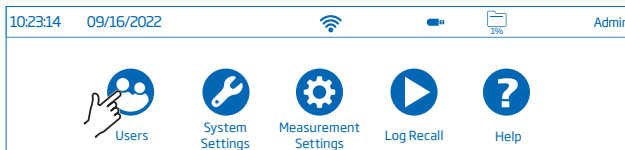

**Users** is the first item under the System Menu and enables multiple-user configuration, rights management, and account creation.



On first access, "Admin" is the default user name and no password is required. Default options are updated from the Users menu.

Function	Administrator*	Standard User
Enable account creation	✓	—
Reset password	✓	—
Delete account	✓	—
Assign administrator rights	✓	—
Use Factory Settings reset	✓	—
Use Reset User settings	✓	✓
Customize settings	✓	✓
Add FTP information	✓	✓
Change password	✓	✓
View and delete personal log files	✓	✓

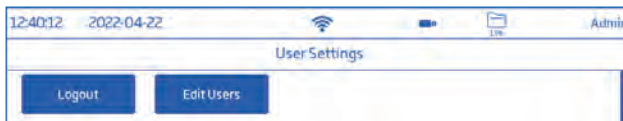

### Log in & Create New Account

1. Power the instrument.  
Wait for the initialization process to complete.
2. Tap  to enter Measurement screen.  
*Note: Tap  (under ) to disable Tutorial.*
3. Tap  followed by .
4. Tap **Edit Users** to enter Account Management.

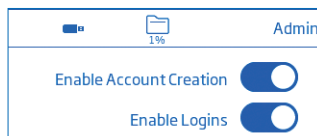

5. Tap  to enable Account Creation and Logins.



6. Tap  to return.
7. Tap **Logout** to enter Users screen.  
"Admin" account will be the first account.
8. To add another user, tap the **plus** symbol avatar.
9. Input user name and tap .
10. Enter password and tap . Reenter password to confirm.
11. Enter users email address (required if sharing files by email).

- Tap  again to add additional user information. The present Users information screen will open. There are 4 information boxes (part of log records if desired) that may be filled with credentials. The user may also fill out FTP details.

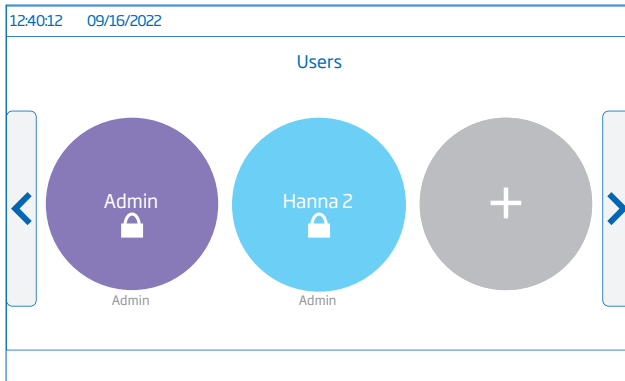

*Note: each power up requires user selection before instrument enters measurement mode.*

**Log Out & Switch User**

- Tap  followed by **Logout**.
- Tap user's account avatar.
- Input password.

**Adding & Removing Users (Admin only)**

- Tap  followed by .
- Tap **Edit Users** to enter Account Management screen and start editing.

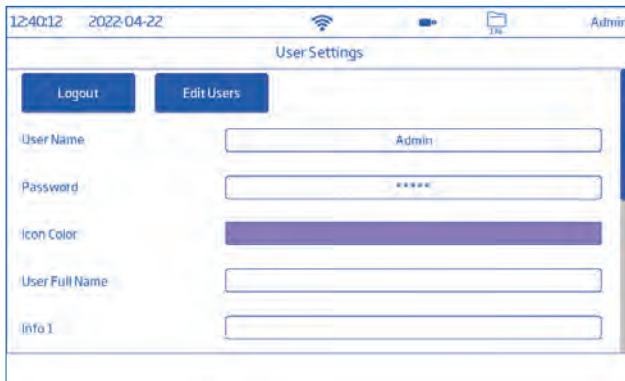

### Configure user settings

Name, Password, assigned avatar color, Full Name, information fields, FTP-dedicated fields, Email Address

- To edit option, tap field and use the on-screen keypad to input information.
- Use the FTP dedicated fields and e-mail address for file transfer of logged data.

**Note:** Entering a valid e-mail address is required for file sharing.

### Account Management (Admin only)

- Enable Account Creation
- Enable Logins
- Enable Admin avatar
- Reset Password. Reset (remove) other users passwords.
  1. Select **Edit Users** tab.
  2. Tap **Reset Password**.

The password is deleted and user can set a new password.

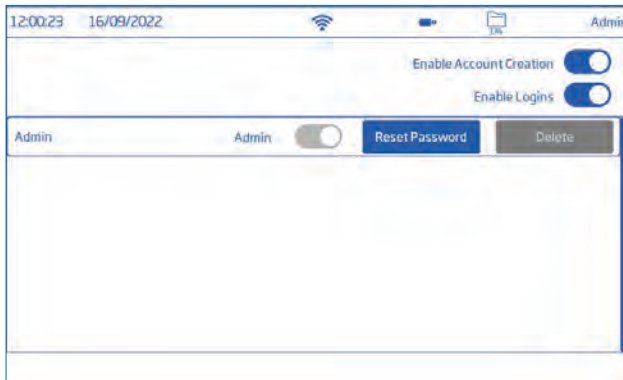

- Delete users
  1. Select **Edit Users** tab.
  2. Tap **Delete** from the user you wish to remove.

The instrument prompts for confirmation.

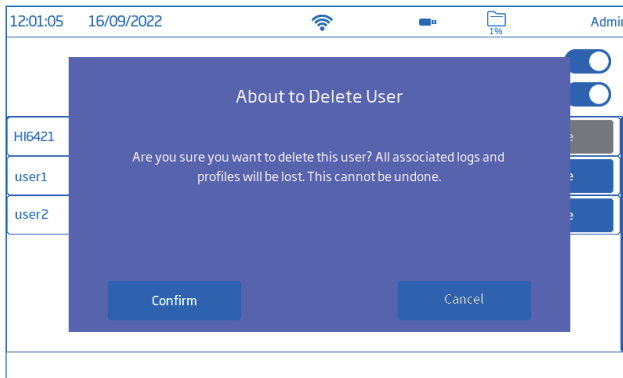

## 8.2. SYSTEM SETTINGS

**System Settings** is the second item under the System Menu.

**Network, Connect & Print, System** tabs permit users to navigate system settings and operations, configure network connection and architecture, connectivity and printing services, change system settings, and view meter information. Every user must configure their own preferences.

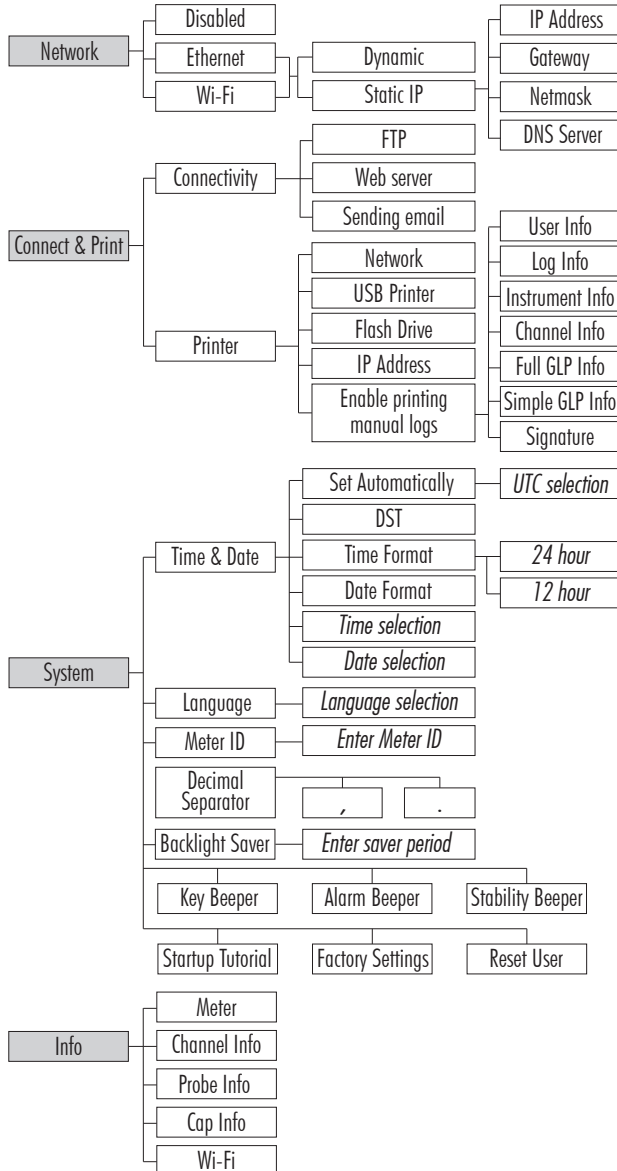



## Network

### Data sharing options: Ethernet, Wi-Fi, or Disabled

With connection established, IP assignment can be set as:

- Dynamic — IP Address, Gateway, Netmask, DNS Server are auto assigned
- Static — network details are entered manually

Input network information

1. Tap **IP Address** field.
2. Input address and tap .

Connect to Ethernet

1. Connect cable to back of meter labeled Ethernet and to wall Ethernet outlet.
2. Tap **Ethernet**.

Connect to Wi-Fi

1. Tap **Wi-Fi**.

**Note:** every user must connect to Wi-Fi individually.

2. Select the IP address type (Dynamic or Static).
3. Tap **Press to select network**.
4. Scan options and select preferred network.  
Enter password if / when prompted.
5. Tap  to confirm.

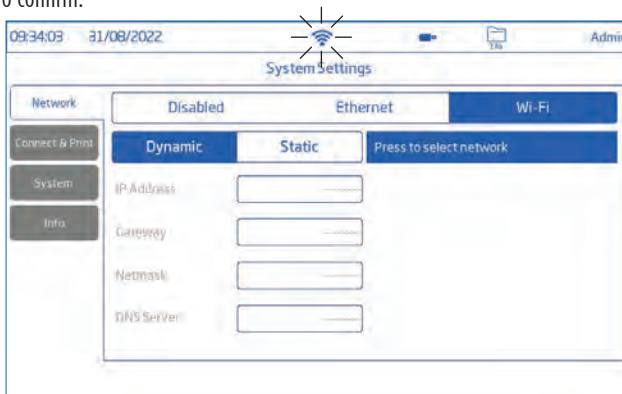

**Notes:** With connection established, tap  or  to check IP address or verify connection status.  
When attempting to connect  icon is displayed  5 sec. .

## Connect & Print

### Options: Connectivity, Printer

#### Connectivity

Tap  to enable (disable) following connectivity options:

- FTP access to meter: log file transfer to an FTP site and meter FTP server connection to client (log download)
- Meter web server: log file download to a web client

- Sending emails: log file transfer via email.

**Note:** Email address is entered under User.

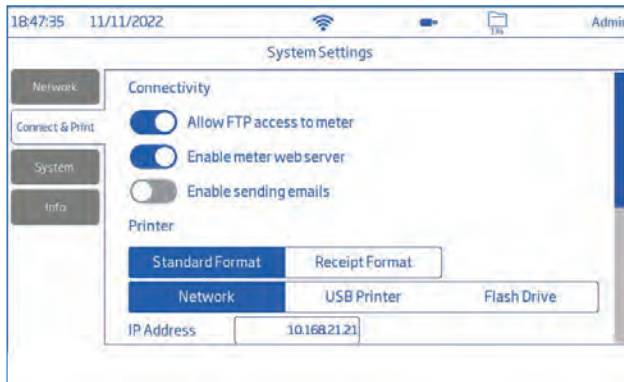

## Printer

### Supported printer types: Standard, Thermal

- Select **Standard Format** to print on an international (ISO) or North American (ANSI) paper size standard.
- Select **Receipt Format** to configure information to be printed on a receipt format.

### Print document options: Network, USB Printer, Flash Drive

- Select **Network** to connect a printer in the same network.  
Tap to enter IP address.
- Select **USB Printer** to connect a printer via USB-A port.
- Select **Flash Drive** to export log files directly to USB Flash Drive.
- Tap **Enable printing manual logs** to send files to configured printer.  
Tap to enable for printing: User, Log, Instrument, and Channel information; Full GLP, Simple GLP, Signature.

**Note:** The connection to the printer (Flash drive) must be made prior to enabling the field selections.  
Ensure internet connection established between printer and internet.



## System

Options: Time, Date, Language, Meter ID, Decimal Separator, Backlight Saver, Beepers, Startup Tutorial, Factory Settings, Reset User

*Note: Use the scroll bar to view or select from entire settings list.*

### Time & Date

Tap  to enable (disable):

- **Set Automatically** (meter must be connected to the internet)
  - ▶ Direct selection from scrollable list of options
  - ▶ UTC options:
    - from UTC 00:00 to UTC+ 14:00
    - from UTC 00:00 to UTC -12:00
- **DST** (Daylight Savings Time) seasonal time change is used in some locations that advances clocks (typically by one hour) during warmer months.

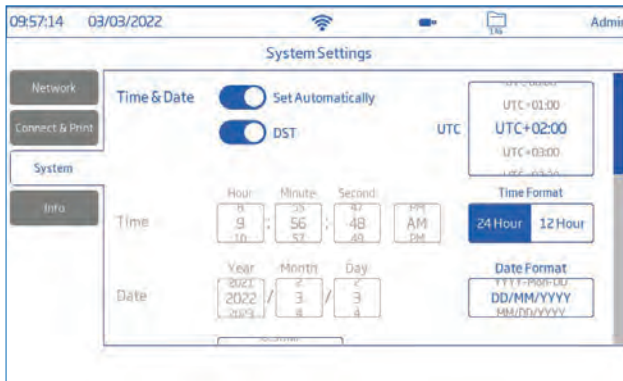
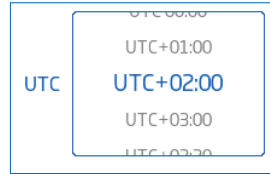

**Time:** Hour, Minute, Second, time of day (AM or PM), time format (24 or 12 Hour)

*Note: Set Automatically must be disabled.*

**Date:** Year, Month, Day

*Note: Date format can be changed if date is configured Automatically (UTC option)*

**Display format:** DD-Mon-YYYY; YYYY-Mon-DD; DD/MM/YYYY; MM/DD/YYYY; YYY/MM/DD; YYYY-MM-DD; Mon DD, YYYY

*Note: Set Automatically must be disabled.*

**Language:** change meter's interface language (select from list of supported options)

**Meter ID** (Admin only)

- Name the meter with a discrete name, location, or number.
- Tap  to save.

Tap  (or corresponding tab) to enable (disable) following settings:

**Decimal Separator:** comma or period, depending on regional preference

**Backlight Saver:** enabled, 1 to 60 minutes (or disabled)

If the backlight turns off after the set period of time, tap screen to turn it back on.

**Beeper:** Key, Alarm, Stability

When enabled, an audible signal alerts users in the event of a wrong key press, an alarm condition, or the stability threshold being exceeded.

**Startup Tutorial:** if disabled (default enabled) the meter does not display the tutorial steps upon power up.

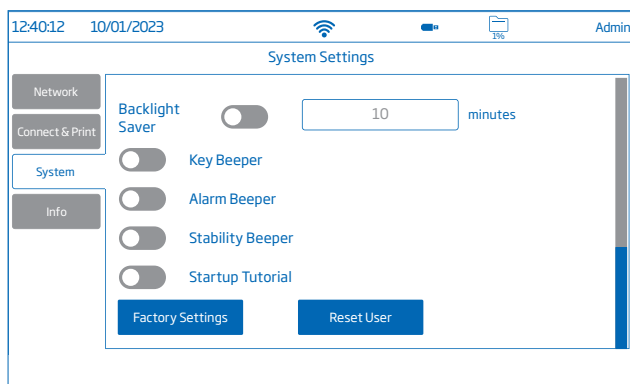

### Factory Settings (Admin only)

Option restores system settings i.e. resolution for measured data, temperature unit, view mode, and alarm to original factory values. Restoring factory settings deletes all user information (including calibration), logs, or configured measurement profiles of all users. When option invoked, the instrument asks for confirmation.

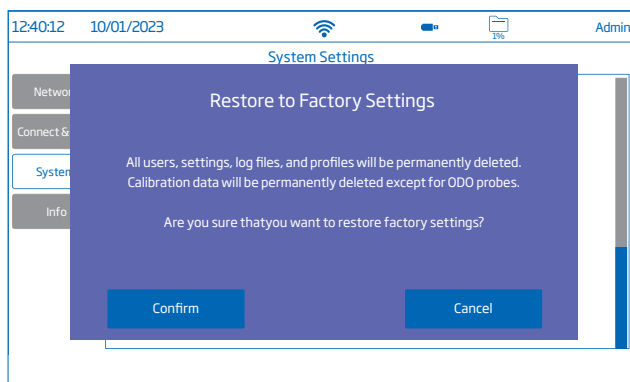

**Note:** The optical sensor stores calibration data on the probe and will not be cleared of data if this function is exercised with the probe connected.

## Reset User

Option restores default settings for this user. All user specific data is permanently deleted, with the exception of username, password, and sensor calibration. Log files and configured profiles are permanently deleted. When option invoked, the instrument asks for confirmation.

## Info

Info displays meter, channel, and Wi-Fi information. If the Wi-Fi is not being used, Wi-Fi displays “Not Enabled.”  
**with optical probe:** probe and cap information is stored



**with polarographic probe**



### 8.3. MEASUREMENT SETTINGS

**Measurement Settings** is the third item under the System Menu and allows setting calibration, reading, temperature, view, alarms, logging, and measurement profile options.

*Note: This function can also be accessed from the Measurement screen directly.*

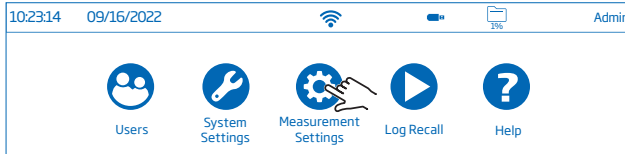

#### Measurement Setup Overview

**Calibration, Reading, Temperature, View, Alarms, Logging, Profile** tabs help user navigate through all measurement operations. The following table presents an overview of possible functions.

<b>Calibration</b>	Last Calibration	Calibrate Clear
	Standard Entry Type	Automatic Manual
	Calibration Reminder	Disabled Daily Periodic
<b>Reading</b>	Stability Criteria	Accurate Medium Fast
	Unit	% Sat, mg/L, ppm
	Reading Mode	Direct Direct/Autohold
	Pressure Source	Automatic Manual
	Pressure	Active when Manual is selected 450.0 to 850.0 mmHg
	Pressure Unit	mmHg, mbar, kPA, inHg, psi, atm
	Salinity	0-130% (where 100% = 35 PSU) 0-45 g/L 0-45 PSU
	Salinity Unit	% g/L PSU

Temperature	Temperature Source	Automatic Manual
	Temperature Unit	°C, °F, K
	Manual	−20.0 to 120.0 °C; −4.0 to 248.0 °F; 253.2 to 393.2 K
	User Temperature Calibration	Calibrate Clear
View	View Type	Basic, Simple GLP, Full GLP, Graph, Table
Alarms	High / Low DO	0.0 to 600.0 % Sat
	High / Low Pressure	450.0 to 850.0 mmHg
	High / Low Temp.	−20.0 to 120.0 °C; −4.0 to 248.0 °F; 253.2 to 393.2 K
Logging	Logging Type	Automatic Manual Autohold (Reading Mode must be Direct/Autohold)
	Sampling Period (Automatic type only)	1, 2, 5, 10, 30 sec. 1, 2, 5, 10, 15, 30, 60, 120, 150, 180 min.
	File Name	Create (Manual or Autohold logging type only)
	Log Note	User defined
	Log Info 1 to 4	User defined
	Sample ID	None Increment Manual
Profiles	Profile Feature	Enable Disable
	Current Profile	Save As Save Delete
	Load Profile	Configured profiles

#### 8.4. LOG RECALL

**Log Recall** is the fourth item under the System's Menu and allows log selection, sharing, and deletion. Logged data is retrieved only by the user that has logged the data.

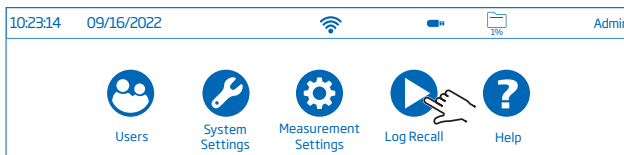

- Data is stored in .CSV files.
- Storage location is independent and organized by user.

- A log (file) can store 1 to 50 000 records i.e. saved measurement data points.
- A single user can store a maximum of 1 000 000 data points.
- Removing or deleting logs frees up log space for additional log files.

**View**

Data can be viewed, plotted (graph), or tabulated (complete with date, time, notes).



From the System Menu screen:

1. Tap  (Log Recall). The instrument displays the Log Recall screen.  
Tap on corresponding table header element to order logged data by Name, Parameter, Start/Stop time stamp, #Samples.  
Tap the up arrow to reverse order.

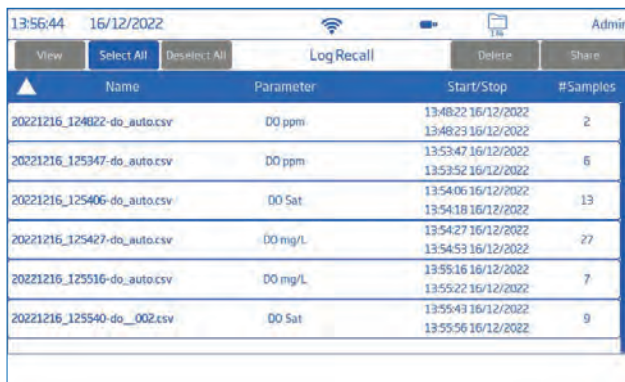
*Note: Option available with .CSV file selected only.*



Name	Parameter	Start/Stop	#Samples
20221216_124822-do_auto.csv	DO ppm	13:48:22 16/12/2022 13:48:23 16/12/2022	2
20221216_125347-do_auto.csv	DO ppm	13:53:47 16/12/2022 13:53:52 16/12/2022	6
20221216_125406-do_auto.csv	DO Sat	13:54:06 16/12/2022 13:54:18 16/12/2022	13
20221216_125427-do_auto.csv	DO mg/L	13:54:27 16/12/2022 13:54:53 16/12/2022	27
20221216_125516-do_auto.csv	DO mg/L	13:55:16 16/12/2022 13:55:22 16/12/2022	7
20221216_125540-do_002.csv	DO Sat	13:55:43 16/12/2022 13:55:56 16/12/2022	9

2. Tap **Name** field to select .CSV file.
3. Tap **View**.
4. Tap  or  icon to have logged data displayed in tabulated form or plotted.

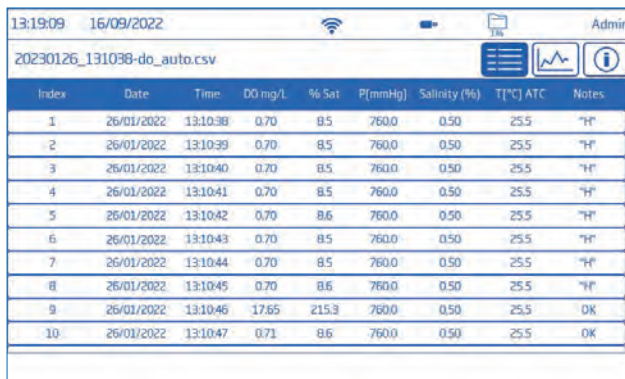

Index	Date	Time	DO mg/L	% Sat	P(mmHg)	Salinity (%)	T[°C] ATC	Notes
1	26/01/2022	13:10:38	0.70	8.5	760.0	0.50	25.5	"H"
2	26/01/2022	13:10:39	0.70	8.5	760.0	0.50	25.5	"H"
3	26/01/2022	13:10:40	0.70	8.5	760.0	0.50	25.5	"H"
4	26/01/2022	13:10:41	0.70	8.5	760.0	0.50	25.5	"H"
5	26/01/2022	13:10:42	0.70	8.6	760.0	0.50	25.5	"H"
6	26/01/2022	13:10:43	0.70	8.5	760.0	0.50	25.5	"H"
7	26/01/2022	13:10:44	0.70	8.5	760.0	0.50	25.5	"H"
8	26/01/2022	13:10:45	0.70	8.6	760.0	0.50	25.5	"H"
9	26/01/2022	13:10:46	17.65	215.3	760.0	0.50	25.5	OK
10	26/01/2022	13:10:47	0.71	8.6	760.0	0.50	25.5	OK



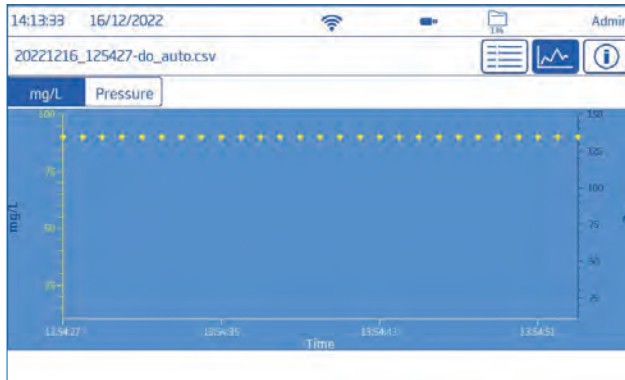

Tap  icon and scroll through USER, LOG, INSTRUMENT, CHANNEL, GLP DATA information.

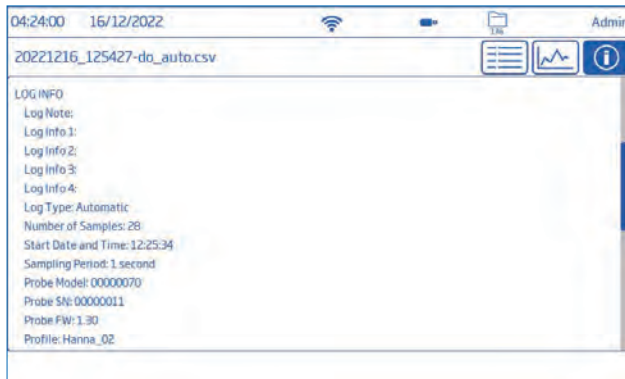

## Select (Deselect) All

To export to a USB-A flash drive:

1. Tap  (Log Recall) to access the Log Recall.
2. Tap **Select All** button to select all log files.  
With all files selected, tap **Delete** to empty the log or tap **Share** to transfer data.
3. Tap **Deselect All** to clear selection.

## Delete

1. Tap  (Log Recall) to access log files.
2. Tap to select required .CSV file (one file) or tap **Select All**.
3. Tap **Delete**.

- The instrument prompts for confirmation.  
Deleted files can not be recovered and the Log Recall screen is displayed blank.

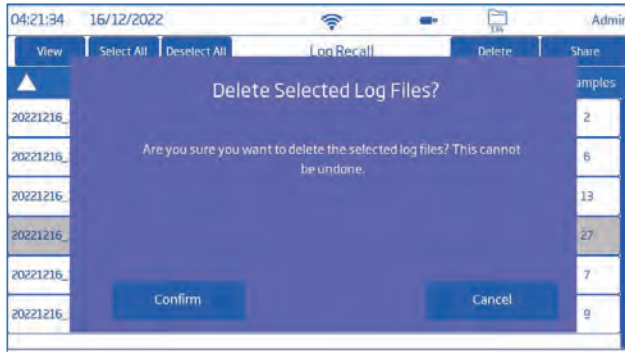

## Share

Options: USB-A, FTP, Email, Print, Web server

### USB-A and USB-C

Plug the USB flash drive into the USB port located on the back.

- Tap (Log Recall) to access Log Recall.
- Select file(s) for transfer or use **Select All** option.
- Tap **Share**. Pop-up flyout is displayed.
- Tap to select USB-A or USB-C. is displayed during data transfer.
- Transfer completion is confirmed and the instrument returns to Log Recall screen.

## FTP

**HI6421** can act as an FTP server (host) or client. Meter has to be connected to the internet and **Allow FTP access to meter** enabled. See System Settings section, Connect & Print tab.

- Use meter's IP address and password to connected and view logged files.
- Enter in the FTP dedicated fields own server information to export logged files to the FTP server.
- Configure FTP server info in the User menu () to use the meter as an FTP client and upload files to an FTP server.

How to connect via **FTP to meter server**

- On preferred FTP software, type the meter's IP address in the Host field.
- Enter the username and password of the user currently logged in.
- Connect to view the files logged on the meter.



How to connect the **meter** to an **FTP server** and share logs

1. In Users menu, type selected server's IP address, username, and password.
2. From System Menu, tap . Log Recall screen opens up.
3. Select file(s) for transfer.
4. Tap **Share**. Pop-up flyout is displayed.
5. Tap to select FTP. The files are being transferred in the root folder of the server.

### FTP server installation and configuration

- PC running Windows 10 or later
- Password protected Windows account
- FTP server must be allowed through the Windows Firewall

#### Installation

1. Navigate to **Start** > **Control Panel** > **Administrative tools** > **Server Manager**.
2. Go to **Roles** and expand **Web Server**.
3. Right click on **Web Server** and then click on **Add Role Services**.
4. Go to **Role Services** and check **FTP Server**.
5. Ensure **IIS Manager** (Internet Information Services) is checked under **Management Tools**.
6. Click **Next** followed by **Install**.
7. Wait for installation to complete.

#### Configuration (PC must be running Windows 10 or later)

1. Navigate to **Start** > **Control Panel** > **Administrative tools** > **IIS Manager** (Internet Information Services).
2. Double click to expand the **IIS Manager** console.
3. Right click on **Sites**, on the Connection pane.
4. Click on **Add FTP Site**, to select. Type the FTP server name and the path to be used for file transfer.

***Note:** Select **Make New Folder** to create a designated folder to store FTP files.*

5. Click **Next**.
6. In the Binding and SSL Settings window keep all default settings but change the SSL option to **No SSL**.
7. Click **Next**.
8. When prompted to authenticate and authorize information, select **Basic and Specified** users.
9. Type local account name to gain access to the server.
10. Check both **Read** and **Write** options.
11. Click **Finish**.

## Email

Meter has to be connected to the internet and **Enable sending emails** enabled (see System Settings, Connect & Print section).

Tap  to access the Users menu and input email address.



18:18:41 11/11/2022 Admin

User Settings

Info 3 info text 3

Info 4 info text

Email Address: admin@email.com  
\*required for filesharing

FTP IP Address: 10.168.19.10

FTP User Name: ftp-user-name

FTP Password: \*\*\*\*\*

1. From System Menu, tap  to access Log Recall.
2. Select file(s) for transfer or use **Select All** option.
3. Tap **Share**. Pop-up flyout is displayed.
4. Select **Email**.
5. Transfer completion is validated when the hourglass disappears and the instrument returns to Log Recall screen.

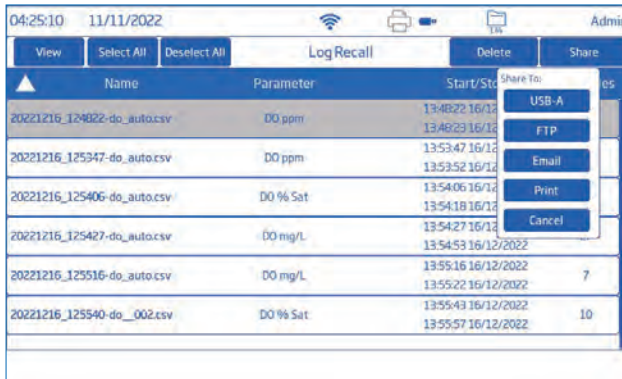

04:25:10 11/11/2022 Admin

View Select All Deselect All Log Recall Delete Share

Name	Parameter	Start/Stop	Share To
20221216_124822-do_auto.csv	DO ppm	13:48:22 16/12/2022 13:48:23 16/12/2022	USB-A
20221216_125347-do_auto.csv	DO ppm	13:53:47 16/12/2022 13:53:52 16/12/2022	FTP
20221216_125406-do_auto.csv	DO % Sat	13:54:06 16/12/2022 13:54:18 16/12/2022	Email
20221216_125427-do_auto.csv	DO mg/L	13:54:27 16/12/2022 13:54:53 16/12/2022	Print
20221216_125516-do_auto.csv	DO mg/L	13:55:16 16/12/2022 13:55:22 16/12/2022	Cancel
20221216_125540-do_002.csv	DO % Sat	13:55:43 16/12/2022 13:55:57 16/12/2022	7
			10

## Print

- Connect either a printer (Network or USB) or plug-in a USB Flash Drive (see System Settings, Connect & Print section).
- Tap **Print** and follow on-screen instructions.

## Web server

Any browser can be used to access the web server and download log files. Meter has to be connected to the internet and **Enable meter web server** enabled (see System Settings, Connect & Print section).

**Note:** Both the meter and the device the browser is accessed from have to be connected to the same network.

1. Tap  for IP address and type address in the browser.



2. Enter the username and password of current user to gain access to logs and tags. Click on file to download to the PC.

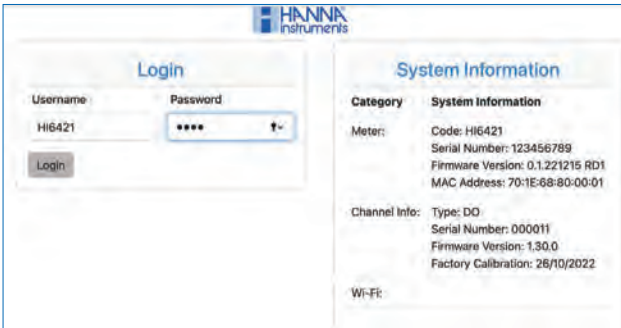

File Name	Parameter	Number of Entries	Start Time	Stop Time		
20221216_124822-dc_auto.csv	DO ppm	2	13:48:22 16/12/2022	13:48:23 16/12/2022	Download	View
20221216_125947-dc_auto.csv	DO ppm	6	13:53:47 16/12/2022	13:53:52 16/12/2022	Download	View
20221216_125406-do_auto.csv	DO % Sat	13	13:54:06 16/12/2022	13:54:18 16/12/2022	Download	View
20221216_125427-do_auto.csv	DO mg/L	27	13:54:27 16/12/2022	13:54:53 16/12/2022	Download	View
20221216_125516-do_auto.csv	DO mg/L	7	13:55:16 16/12/2022	13:55:22 16/12/2022	Download	View
20221216_125540-dc_002.csv	DO % Sat	10	13:55:43 16/12/2022	13:55:57 16/12/2022	Download	View

## PC connection

The logged data can be transferred from the meter to a PC.

- Use the USB-C cable to connect the meter to the PC.
- The meter will appear as a flash drive on the computer.
- Save files to the PC. All logs will be listed as .CSV files.

The .CSV files may be opened with any text editor or spreadsheet application.

All features of the spreadsheet program can be used to analyze and graph the data.

## 8.5. HELP

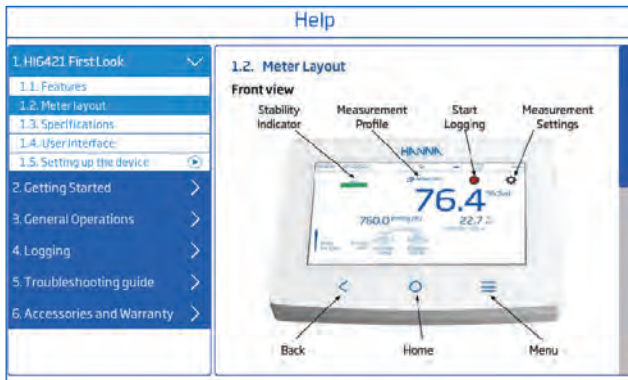
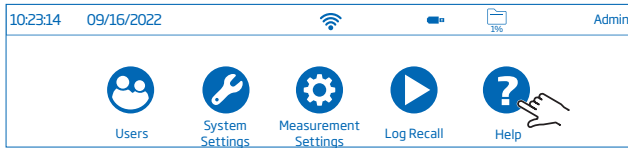

**Help** is the fifth item under the System Menu.

- Tap  to access support and navigate through an overview of system's main functions.



- Tap video to play (stop) video-supported segments:
  - ▶ 1.5. Setting up the device
  - ▶ 3.1. Calibration
  - ▶ 3.2. Reading measurements
- Tap  once to increase video speed.
- The meter supports three playback speeds increasing with each tap:
  - ▶ normal ( $\times 1$ )
  - ▶ medium ( $\times 2$ )
  - ▶ fast ( $\times 4$ )

## 9. MEASUREMENT & PROBE SETUP MENU

From the Measurement screen, tap  to access system and measurement configuration tabs. Alternatively, tap  (Menu key) then .

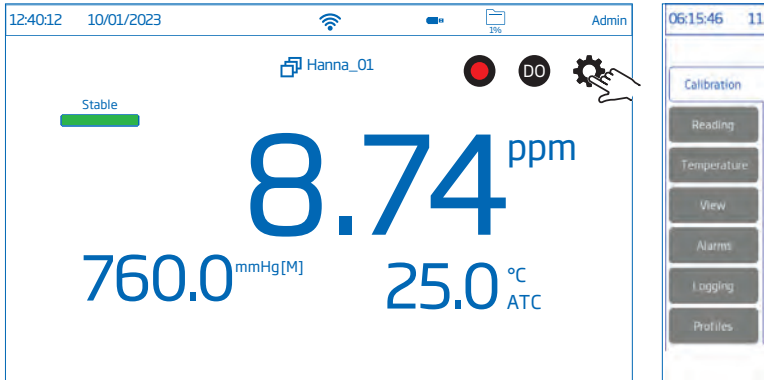

### 9.1. CALIBRATION

Options: Last Calibration, Standard Entry Type, Calibration Reminder, User Pressure Calibration

**Last Calibration:** calibrate or clear a previous calibration

**Standard Entry Type**

- **Automatic:** meter selects the closest calibration standard value to that of the sample being measured
- **Manual:** user selects the standard to be used for calibration

**Calibration Reminder**

- **Disabled**
- **Daily-**calibration interval (hours and minutes)
- **Periodic-**calibration interval (days, hours, minutes)

“Calibrate probe” message is displayed if calibration is not done within set interval.

**User Pressure Calibration:** option available with Pressure Source set to Automatic (under **Reading** tab)

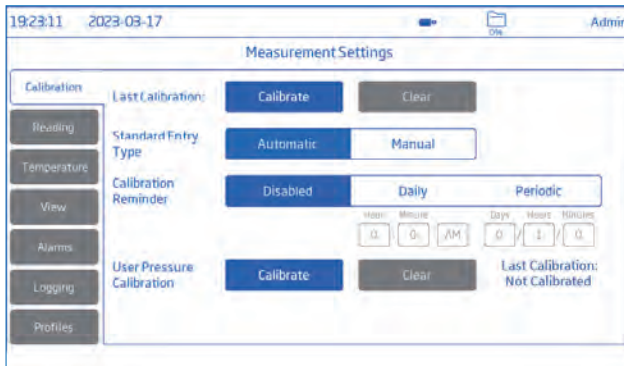

## 9.2. READING



Options: Stability Criteria, Unit, Reading Mode, Pressure Source, Pressure, Pressure Unit, Salinity, Salinity Unit



### Stability Criteria

Options: **Accurate, Medium, Fast**

Allows users to set the stability criterion based upon the setting selected.





While the measurement is changing, the stability indicator is shown partially (); when the criteria is reached the indicator is displayed as a full green bar (.

- **Accurate:** for applications where high accuracy is required  
Measurement is recognized as stable using more critical criteria evaluating measurement fluctuations.
- **Medium:** for applications where average accuracy is accepted  
Measurement is recognized as stable using less critical criteria evaluating measurement fluctuations.  
The measurement may still change after registering stable.
- **Fast:** for applications when stability-evaluation methods are not so critical

Unit: % Sat, mg/L, ppm

### Reading Mode

Options: **Direct, Direct/Autohold**

- **Direct:** as measurement changes, measurement stability is continuously evaluated. Unstable (blinking) or Stable indicator are displayed above the progress bar.
- **Direct/Autohold:**  (lock icon) is displayed between the log and Measurement Menu icons.
  - ▶ Tap  to initiate a measurement.  is displayed.
  - ▶  is displayed blinking until the measurement is stable.
  - ▶ When stable, the indicator stops blinking and measurement freezes at current value.
  - ▶ Tap  to return to direct measurement.



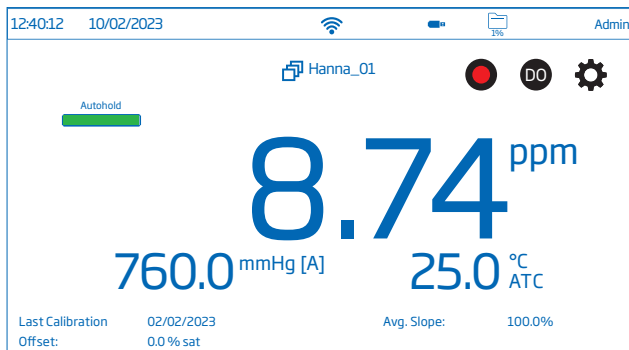

### Pressure Source, Value, Unit

Users can configure the meter-integrated barometer.

**Note:** The meter's integrated barometer may be calibrated under **Calibration** tab. Source must be set to **Automatic**.

- Source: Automatic, Manual
- Value: Tap **Manual** dedicated field and enter the calibration pressure in desired units.
- Unit: mmHg, mbar, kPA, inHg, psi, atm. Tap to select desired unit.

### Salinity Value, Unit

- Salinity value: tap dedicated field to enter value.
- Unit: %, g/L, PSU. Tap to select unit.

## 9.3. TEMPERATURE

Options: Temperature Source, Temperature Unit, Manual, User Temperature Calibration

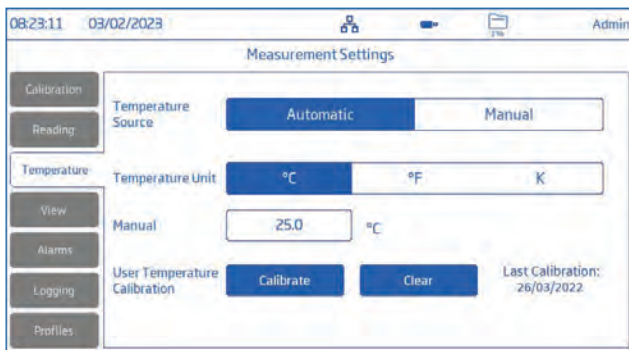

### Temperature Source: Automatic, Manual

Users can select between physical temperature input source (Automatic) and entering sample temperature value manually (Manual).

- Automatic: built-in temperature sensor adjusts measured dissolved oxygen and "ATC" indicates temperature compensation status.
- Manual: sample temperature is entered manually and "MTC" indicates temperature compensation status.

Temperature Unit: Celsius, Fahrenheit, Kelvin degrees

User Temperature Calibration: Calibrate or Clear (with Automatic Temperature Source selected only)

New temperature calibration procedure

1. Tap **Calibrate**.
2. Place the probe and a reference thermometer into a stirred container of water.  
Allow for the reading to stabilize.
3. If the displayed value is different than the reference thermometer reading, tap **Calibrated Temperature** and use the on-screen keypad to adjust the value to that given by the reference thermometer.
4. Tap **Save** to confirm and save the calibration data.

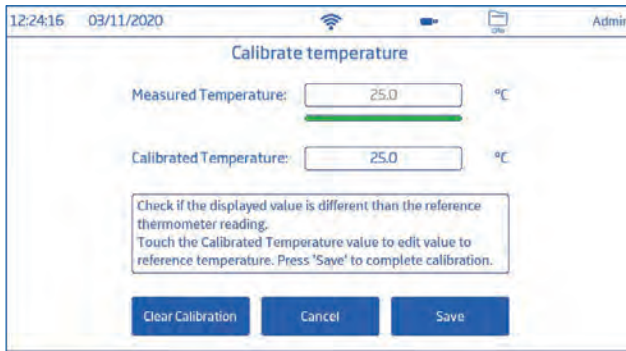

### 9.4. VIEW

Options: Basic, Simple GLP, Full GLP, Graph, Table

- Select preferred display configuration from View Type window.

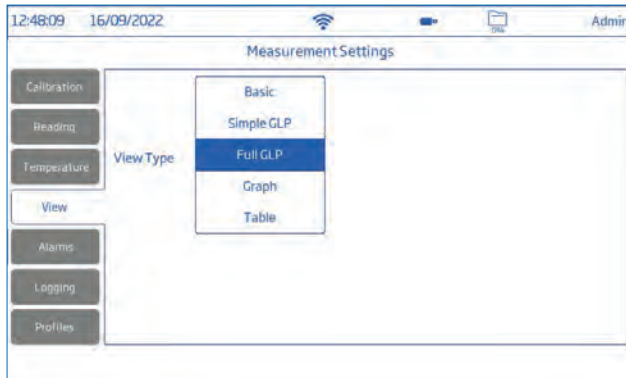

### Basic

Screen displays the measured values, measurement unit, stability and temperature compensation status/source.

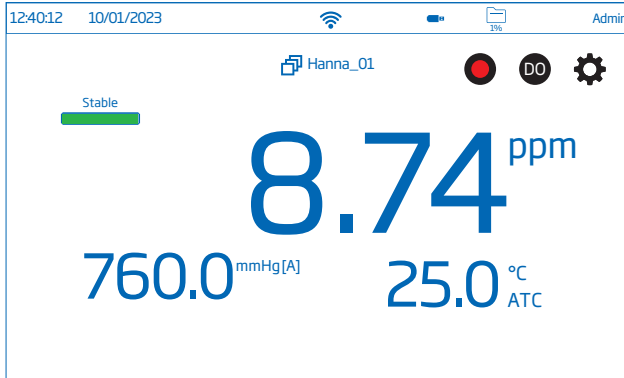

### Simple GLP

Simple GLP screen displays: last calibration date and time, offset value, and average slope (as well as data displayed in Basic screen).

*Note: If no calibration was made, "Not Calibrated" is displayed.*

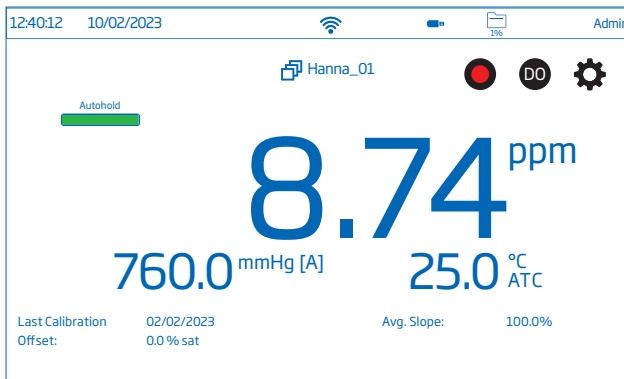

Full GLP

Full GLP screen displays: probe symbol, calibration information, and temperature source (as well as data displayed in Simple GLP screen).

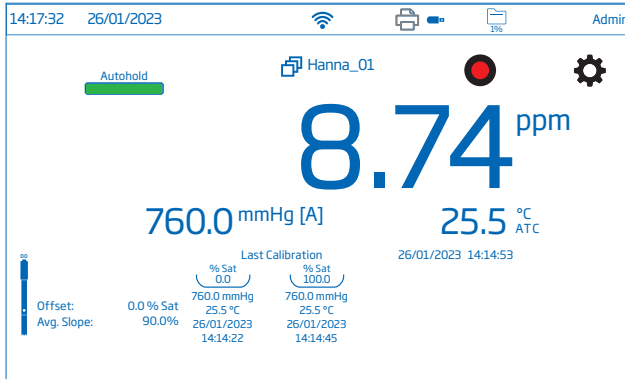

Graph

When Graph is selected, the measured value is plotted as a graph.

To zoom in on a graph:

1. Select Time or parameter axis.
2. With axis selected, pinch (drag) on the display.



## Table

When Table is selected, the measured values are displayed tabulated (complete with date, time, and notes made during logging). The newest data is displayed on the top of the table.

ppm	mmHg	T(°C)	Time	Date	Notes
8.11	760.0	25.0	12:42:41	16/09/2022	
8.10	760.0	25.0	12:42:40	16/09/2022	
8.19	760.0	25.0	12:42:39	16/09/2022	
8.18	760.0	25.0	12:42:38	16/09/2022	
8.17	760.0	25.0	12:42:37	16/09/2022	
8.16	760.0	25.0	12:42:36	16/09/2022	
8.15	760.0	25.0	12:42:35	16/09/2022	
8.74	760.0	25.0	12:42:34	16/09/2022	
8.73	760.0	25.0	12:42:33	16/09/2022	
8.72	760.0	25.0	12:42:32	16/09/2022	
8.71	760.0	25.0	12:42:31	16/09/2022	

## 9.5. ALARMS

### Options: High/Low DO value, High/Low Pressure, High/Low Temperature

Users can set the threshold limits for the measured parameters. When the measurement exceeds set high-threshold value or drops below set low-threshold value, the alarm is triggered and an alarm message is displayed.

If the Alarm Beeper is enabled (See: System Menu Items / System Menu Items / Alarm Beeper), an audible beep will be heard.

**Notes:** High-parameter values cannot be lower than low-parameter ones.

Units change with Reading Settings.

To set an alarm limit:

1. Tap to enable low or high parameter threshold option.
2. Use the on-screen keypad to enter the value.
3. Tap **Enter** to confirm (**Cancel** to exit and return to measurement settings).

Parameter	Unit	Value	Toggle
High DO	% Sat	0.0	Off
Low DO	% Sat	0.0	Off
High Pressure	mmHg	800.0	On
Low Pressure	mmHg	460.0	On
High Temperature	°C	50.0	On
Low Temperature	°C	10.0	On

(alarm icon) is displayed on the measurement screen when an alarm is active.

## 9.6. LOGGING

Options: Logging Type, Sampling Period, File Name, Log Note, Log Info, Sample ID



### Logging Type

- **Automatic:** data is logged automatically at predefined time intervals (i.e. Sampling Period).
  - ▶ A file name is automatically generated, complete with year/month/day, and log starting time (e.g., 20220329\_085101-do\_auto.CSV).
- **Manual:** data is logged every time **M** is tapped.
  - ▶ A file name is automatically generated, complete with year/month/day e.g. 20220329\_085101-do\_Test\_001.
  - ▶ Alternately, tap **Create** to name a manual log file with a custom suffix. e.g. 20230404\_13570-do\_Derry samples
- **Autohold:** Direct/Autohold reading mode must be configured.

*Note: Manual and Autohold records are stored in the same log file, i.e. data logged on different days is stored in the same file. Automatic records are stored separately.*

*Data logged with Autohold option selected, is identified by the "H" in the Notes column.*

### Sampling Period

Option available only with **Automatic** logging type selected.

Time-interval options are selected from scrollable list.

### File Name

Available only with **Manual** and **Autohold** logging type selected.

To create a file name, from Logging screen:

1. Tap **Create**.
2. Use the on-screen keypad to enter a file name (maximum 13 characters).
3. Tap **↩** to confirm.

### Log Note & Log Info

Notes on measured data are saved together with logged data.

## Sample ID

Manual and autohold samples can be labeled with a numerical ID (increments with each new sample logged), a text label, or a text label with numerical ID.

With **Increment** selected:

1. Tap **Sample ID**.
2. Use the on-screen keypad to enter a text prefix, of maximum 15 characters, to the sample name.
3. Tap  to confirm.
4. Select increment from scrollable list.

## 9.7. PROFILES



**Option: Profile Feature, Current Profile** (configure), **Load Profile** (previously configured)

- Tap  to enable(disable) **Profile Feature** option.

### Current Profile

A profile is a sensor setup complete with required measurement and temperature unit, display preference, and alarm threshold options. Once configured and saved the profile can be loaded for applications that require similar configurations.

To save a profile, having previously configured all other application-specific options, from the Measurement screen:

1. Tap .
2. Tap **Profiles** tab.
3. Tap **Save As** and use the keypad to enter profile name.
4. Tap  to confirm.

Once saved, profile name is added to the Load Profile list.

### Load Profile

1. Tap to select a configured profile from the **Load Profile** list.
2. Profile name is automatically entered in the **Current Profile** field.
3. Start measuring.

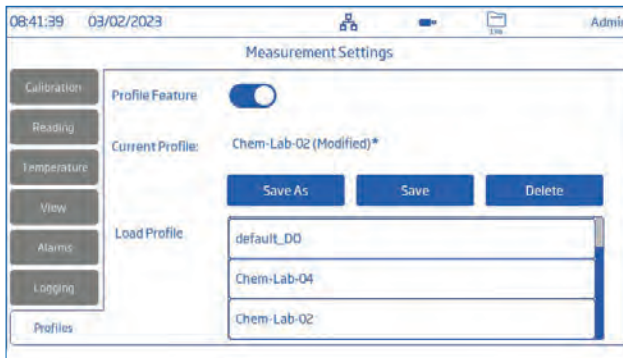

**Note:** Profile setting modifications are indicated by an asterisk (\*) in measurement screen.

## 10. CALIBRATION

The accuracy of dissolved oxygen measurement is directly related to the sensing surface cleanliness and calibration technique. Oily coatings and biological contaminations are the primary cause of calibration drift. A standard solution or a reference DO meter may be used to compare readings during calibration.

HI6421 and HI6421P support:

- Two-point calibration at 100.0 % saturation (or 8.26 mg/L) and 0.0% saturation (or 0.00 mg/L)
- Single-point manual calibration using a standard value set by user (% saturation or mg/L)
- Single-point calibration at 0.0 % saturation (or 0.00 mg/L)
- Single-point calibration at 100.0 % saturation (or 8.26 mg/L)

Calibrate the probe frequently. Additionally, calibration is recommended:

- After probe replacement
- At least once a week
- Following calibration reminder

### **Note:**

- ▶ Perform Temperature calibration (and Pressure if required) prior to DO probe calibration.
- ▶ If calibrating in concentration units, 8.26 mg/L (ppm) is displayed but the actual value of air saturated water at pressure and temperature used for calibration.
- ▶ When automatic calibration is performed it is assumed that the standard value is 100 % water saturated air and 0% O<sub>2</sub> saturated solution.
- ▶ When a user calibration is performed it is assumed that the standard value is the DO value at the current pressure, temperature and salinity.

### General Guidelines

- Set up a routine service schedule where measurement integrity is validated.
- Do not handle the sensing surface of the sensor.
- Avoid rough handling and abrasive environments that can scratch the reactive surface of the sensor.
- Do not return the used standard to the bottle of “fresh” solution.
- For measurements across a temperature gradient (when water temperature is drastically different from the standard), allow the sensor to reach thermal equilibrium before conducting calibrations or making measurements. The heat capacity of the probe is much greater than the air.
- During calibration, the temperature sensor must be in the calibration solution.
- When calibrating in water-saturated air ensure there are no droplets on the DO sensor sensing surface.

### 10.1. PROBE PREPARATION

#### Optical Probe (HI7641133)

**Required accessories:** Smart Cap and O-ring, syringe and sachet with grease, purified water, lens wipe, zero oxygen solution, calibration beakers



1. Remove the shipping cap.
2. Slide the O-ring on the probe tip. Do not roll or twist the O-ring.
3. Use syringe to sparingly lubricate the O-ring with grease.  
Avoid getting grease or fingerprints onto the optical window.
4. Align the cutout arrow on the Smart Cap with the guide on the probe body.

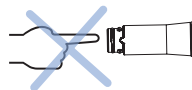

5. Press the Smart Cap onto the probe body until it snaps in place.
6. Handle cap with care!
7. Place the probe in purified water for a minimum of 2 hours to hydrate the Cap before use.

**Note:** Once the cap is installed it should not be removed unless a new cap is required.

Prior to probe initialization, verify time and date are configured correctly in System Settings.

### Polarographic Probe (HI764833)

**Required accessories:** membrane cap and O-ring, electrolyte solution, zero oxygen solution, calibration beakers

- Unscrew the shipping cap and save.
- Take one O-ring and one membrane cap and position the O-ring (1) in the cap (2).

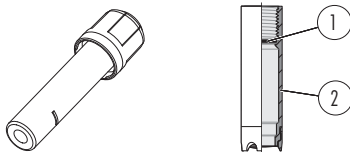

- Rinse the membrane cap with electrolyte and discard.
- Fill the cap, above the O-ring, with electrolyte and tap the side walls to dislodge bubbles that may adhere to the threads.
- Over a sink, with the cathode facing down, screw the cap counter clockwise until the threads are fully engaged.
- Rinse the probe and inspect the membrane for trapped bubbles. If any, discard the electrolyte, refill, and tap the sides. Reinstall.

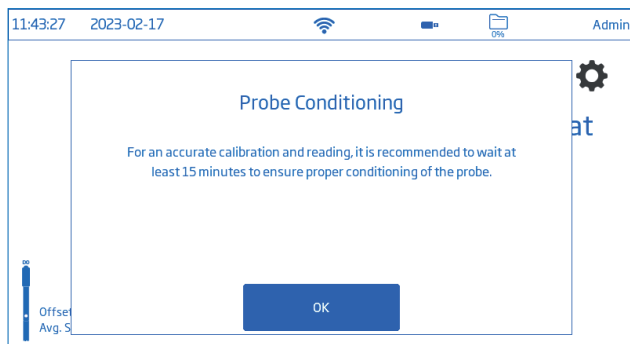

## 10.2. DO CALIBRATION

### Guidelines

- Rinse the probe with purified water.
- Shake any remaining solution off the probe. No droplets should remain on the DO sensor sensing surface.
- For measurements across a temperature gradient (when water temperature is drastically different from the standard), allow the probe to reach thermal equilibrium before conducting calibrations or making measurements.

### Calibration protocol

Slope and Offset use two-point calibration data. During calibration users adjust the sensor's Offset at both 100% and 0% saturation.

### Automatic Calibration

The following options are available for the Dissolved Oxygen calibration:

- Single or two point calibration at 100 or 0% saturation
- Single or two point calibration at 8.26 or 0 ppm (or mg/L)

When automatic calibration is performed it is assumed that the standard value is 100% water saturated air.

### Two-Point Calibration

With the probe correctly plugged in:

1. From Measurement screen, tap  (Measurement Menu icon).
2. Tap on **Temperature** tab and configure **Temperature Source**.
3. Tap **Calibration** tab and configure Standard Entry Type as **Automatic**.
4. Tap **Calibrate** to start the process.
5. Tap **Clear Calibration** to start a fresh calibration and clear all previous calibrations.

If using a new probe, it is recommended to clear all standards and start new.

#### • At 100 % saturation (8.26 mg/L)

##### *Optical probe*

- ▶ Place a moistened sponge in the bottom of the calibration beaker.
- ▶ Place the calibration beaker on the probe body. Do not tighten the calibration beaker on the probe threads.
- ▶ Wait at least 15 minutes for the air to become saturated with water vapor. This condition corresponds to 100 % air saturated water at the temperature of measurement.
- ▶ Allow for the reading to stabilize. The standard value is automatically recognized.

##### *Polarographic probe*

- ▶ Suspend probe with membrane just over beaker of water. Do not put the sensor in an sealed container.

#### • At 0 % saturation (0 mg/L)

- ▶ Fill the calibration beaker 2/3 full with [HI7040](#) Zero Oxygen solution and slowly place the probe in the solution.
- ▶ Dislodge bubbles that may adhere to the sensor.
- ▶ Stir gently for 2-3 minutes.

6. Wait for “Stable” to appear before confirming the standard. After the reading has stabilized, tap **Confirm Standard**. The calibration point is added to the tray.
7. Tap **Save**. The meter returns to Measurement screen.



### Single-Point Calibration at 0 % Saturation (0 mg/L) or 100 % Saturation (8.26 mg/L)

Follow steps steps 1-5 under two-point calibration. Then,

- ▶ Place the sensor into selected standard. The standard value is automatically recognized.
- ▶ After the reading has stabilized, tap **Confirm Standard**. The calibration point is added to the tray.
- ▶ Tap **Save** to complete calibration. The meter returns to the Measurement screen.



### Manual Calibration

- Place probe in water sample users want to calibrate.
  - Determine the value of the water sample independently.
1. Tap **Calibration** tab and configure Standard Entry Type as **Manual**.
  2. Place the probe in sample. Allow time for the reading to stabilize.  
Verify temperature sensor is in the sample.
  3. Tap **Edit Standard**, input the % Saturated value, and tap **Save**.
  4. After the reading has stabilized, tap **Confirm Standard**. The calibration point is added to the tray and will replace either 100% (8.26 ppm) saturation or 0% saturation in the current DO Calibration Status.
  5. The meter automatically returns to the Measurement screen.

### 10.3. PRESSURE COMPENSATION

Both concentration (mg/L and ppm) and % saturation values vary with pressure.

#### Automatic Pressure Source

- Select **Automatic** under Pressure Source to use meter's integrated barometer.

#### Manual Pressure Source

1. Use a reference barometer to obtain the true local barometric pressure reading source.

*Note: Do not use the weather-reported barometric pressure readings as local references as readings are corrected for altitude and only show sea-level values.*

2. From Measurement screen, tap  (Measurement Menu icon).
3. Tap **Reading** tab.
4. Configure Pressure Source to **Manual** and configure preferred pressure unit.
5. Tap **Pressure** and input value.
6. Tap **Save**.

### 10.4. SALINITY COMPENSATION

Concentration measurements (ppm and mg/L) in sea water samples require the salinity value input to account for the lower solubility of oxygen in salt water.

#### Procedure

1. From Measurement screen, tap  (Measurement Menu icon).
2. Tap **Reading** tab.
3. Tap to configure preferred Salinity unit.
4. Tap **Salinity**, input value.
5. Tap **Save**.

## 11. MEASUREMENT

#### Options: Direct, Direct/Autohold

- **Direct**: sample measurements are displayed continuously.
- **Direct/Autohold**: reading is displayed until measurement stability is reached. A measurement that has not reached equilibrium will not be used. After stability criteria is reached, the meter holds the value until the user changes to direct measurement again.

### 11.1. GUIDELINES

- Verify the temperature sensor is submerged in sample during measurement.
- Allow the probe to reach thermal equilibrium with the sample.
- Verify if pressure and temperature measurements are reading correctly, and the probe is calibrated in accordance with sampling protocols.
- The probe should be measuring the partial pressure of the dissolved oxygen in water. Gas bubbles have a greater partial pressure due to the surface tension of the bubble. Noisy or erratic measurement, or higher measurements are possible.

- Set Salinity value if measuring ocean or brackish water samples.
- Carefully lower the probe into sample so no trapped air bubbles at the Cap.
- Routinely inspect the probe for biofouling. Routinely clean off the probe with clean water (between measurements). Biologically active waters may require more frequent cleaning.
- Make sure the optical window / membrane is clean, without any coating, for good sample circulation.

## 11.2. MEASUREMENT TIPS

- Ensure probe is correctly plugged in.
- Only work with recently calibrated probes.
- Use the [HI764060](#) holder for easy transfer in and out of containers during sample measurement.
- To limit sample contamination, pour 2 beakers of sample. Use one beaker to rinse the sensor, and another one for measurement.

### Measuring with polarographic probe

- ▶ Place probe in sample and allow reading to stabilize.
- ▶ For accurate measurements the membrane needs constant oxygen replenishment. Ensure adequate water movement either manually or by use of a stirrer.

## 11.3. DIRECT READINGS

From Measurement screen, tap  (Measurement Menu). Next:



- Tap **Reading** tab and select unit.
- Tap **Direct** to select direct Reading Mode.
- Place the probe into the sample to be measured.

Allow time for the reading to stabilize (Unstable status is indicated on the screen until measurement is stabilized).

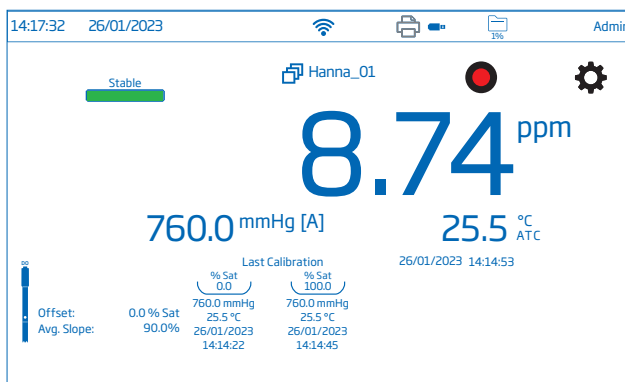
- The measured value is displayed on the LCD, together with GLP information and display preferences.









### 11.4. DIRECT/AUTOHOLD READINGS

Direct/Autohold reading is a reading mode located under the **Reading** tab and identified by  icon on the meter. When selected, the meter will wait until stability criteria is met and once met it will hold the value and display  icon.

To exit Direct/Autohold reading mode and return to regular readings that make visible changes in measurements, users tap  icon. When using Autohold the measurement value can be manually recorded.

#### Procedure

From Measurement screen, tap  (Measurement Menu). Next:

- Tap **Reading** tab and select parameter.
- Tap **Direct/Autohold** to select direct/autohold Reading Mode.
- Place the probe into the sample to be tested.
- Tap  (lock icon) to enable the autohold Reading Mode.
- The measured parameter value will be displayed on the LCD. Allow time for the reading to stabilize.
- Unstable status is indicated with  blinking. When stability criteria is reached  is displayed.
- The measured value is displayed on the LCD, together with GLP information and display preferences.
- While Autohold is enabled ( and  displayed) the reading value is kept on display.
- To return to direct Reading Mode, tap  icon on display.

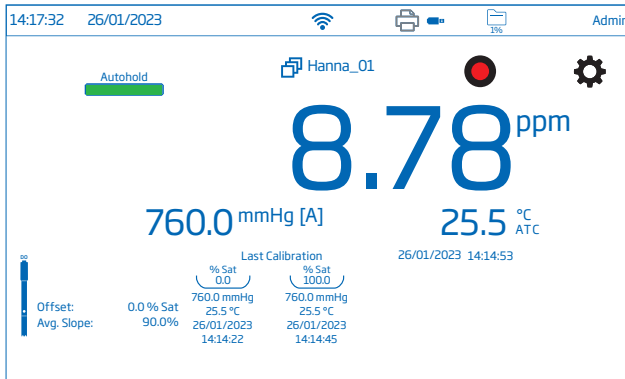

## 12. LOGGING

Tap  to check available storage.

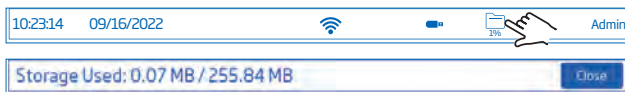

Three logging types are available: Automatic, Manual, and Autohold.

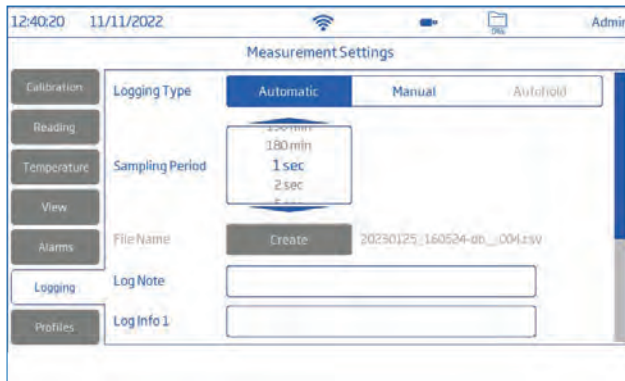

### Automatic logging

- Readings are logged (●) at predefined period intervals. Sampling interval options range from 1 second to 180 minutes.
- Records are continuously added to it until the session stops.
- For each automatic logging session, a new file is created.
- A complete set of GLP information including date, time, mode selection, temperature reading, and calibration information is stored with each log. User and log information e.g. company, address, sample details may also be included on the .CSV file.

### Manual logging

- Readings are logged each time (M) is tapped.
- All manual readings are stored in a single file (i.e. records made on different days share the same file).

### Autohold logging

- Readings are logged each time (D) is tapped and configured stability criteria is reached.
- All Autohold readings are stored in a single log (i.e. records made on different days are logged in the same file).

*Note: Stability criteria can be set to Fast, Medium, or Accurate for all logging types.*

## 12.1. AUTOMATIC LOGGING







1. From Measurement screen, tap ⚙️ (Measurement Menu).
2. Tap **Logging** tab and select **Automatic** logging type.
3. Scroll to select Sampling Period.
4. Tap ○ (Home key) to reenter Measurement screen.
5. From Measurement screen, tap ● symbol to start/stop.

6. During active logging, users can track and log notes.

To add a new log note:



- Tap .
- Use on-screen keypad to enter text.
- Tap  to log entered note. Log Recall view and .CSV log indicate the added log notes.

**Autohold with Automatic logging**



1. Select **Direct/Autohold** in the Reading Mode (**Reading** tab).
2. Select **Automatic** under Logging Type (**Logging** tab).
3. Place probe in sample.
4. Tap  and  symbols to initiate the log.  
Log points will be stored as soon as  is tapped (this includes the changing measurements even when the meter is trying to find a value to hold at).
5. When Autohold is reached,  is displayed and this value will be logged with an “H” in the log notes.
6. Tap  to stop the log and tap  to restore direct measurements.

*Note: Logged data is recorded up to the Autohold changing and every point after is the held value until the log was stopped (i.e. 1,2,3,4,5,5,5,5,5). The Autohold value is identified with an “H” in the log record.*

**12.2. MANUAL LOGGING**

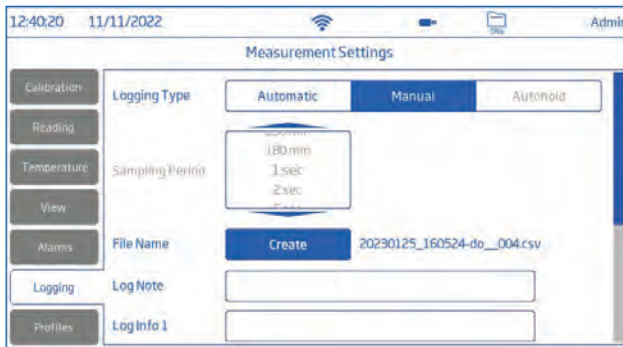
1. From Measurement screen, tap  (Measurement Menu).
2. Tap **Logging** tab and select **Manual** logging type.
3. See option to create file name:
  - Tap **Create**.
  - Use on-screen keypad to enter file name.
  - Tap  to save new name.



4. See option to define sample ID (name and prefix).
5. Tap  (**Home** key) to reenter Measurement screen.
6. From Measurement screen, tap  (manual logging symbol) to log data.  
Data is logged every time symbol is tapped.
7. From Measurement screen, tap  symbol to start/stop logging.



### Autohold with Manual logging

1. Select **Direct/Autohold** in the Reading Mode (**Reading** tab).
2. Select **Manual** under Logging Type (**Logging** tab).

The meter will find a measurement to hold once the meter meets its stability criteria. **Autohold** symbol is displayed.

3. Tap displayed **Hold** symbol to take a manual log of the held measurement. Hold values will be denoted with "H" in the log notes.

**Note:** **Hold** can be tapped either before or after the meter has found its hold value.

4. Tap **Direct** to restore direct measurements.

### 12.3. AUTOHOLD LOGGING

1. From Measurement screen, tap **Settings** (Measurement Menu).
2. Tap **Reading** tab to select stability criteria (Accurate, Medium, or Fast).

**Note:** Autohold logging uses this criteria for logging. Setting this will affect when data is recorded.

3. Tap to select **Direct/Autohold** reading mode.
4. Tap **Logging** tab and select **Autohold** logging type.

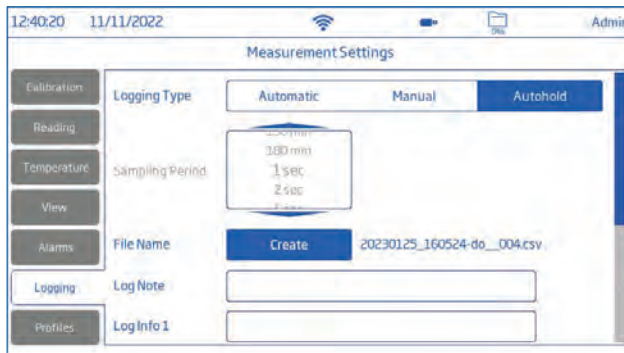

5. Create a file name or have a file previously set up.
6. Option to define sample ID (name and prefix)
  - Tap **Sample ID Prefix** field to start editing.
  - Use the on-screen keypad to enter log file name.
  - Tap **Save** to save new name.
  - Then, scroll to select Prefix value.
7. Tap **Home** key to reenter Measurement screen.
8. Move probe to new sample.
9. Tap **Autohold** to enable autohold.
10. Tap **Autohold Logging** to enable autohold logging. Autohold starts flashing until autohold is reached.
11. Once logged, tap **Direct** to disable autohold.

### .CSV file format naming convention

Files within a data package have the measurement unit automatically included in the file name.

Manual or Autohold logged files retain the distinction between different reading modes in the file name. Users have the option to input file name:

- 20220920\_072224-DO\_auto.CSV
- 20220920\_071058-DOSAT\_002.CSV

### Autohold with Autohold logging

1. Select **Direct/Autohold** in the Reading Mode (**Reading** tab).

2. Select **Autohold** under Logging Type (**Logging** tab).

With Autohold enabled (tap **A** and **B**) the user will see log points stored only when the stability criteria is met ( displayed).

Once the hold value is found, the meter stores this value as a log point into a manual log file.

No other point is stored unless the Autohold is removed (tap **DD**) and the stability criteria is met again.

Whenever Autohold and Autohold logging are enabled together, the user will only see one log point.

3. Tap **DD** to restore direct measurements.

4. To measure the next sample, move sensor into the next sample.

5. Tap **A** to initiate a new Autohold data point.

6. To measure/record additional samples, tap **A** between samples to release the Autohold feature.

## 13. MAINTENANCE

### 13.1. BENCHTOP GENERAL CLEANING

The following steps outline the process to ensure users keep the benchtop clean and disinfected while limiting the risk of damage from unsuitable cleaners.

- Disinfect the screen using commercially available non-ammonia glass or disinfectant cleaner.
- Apply a small amount of cleaner directly to a microfiber or lint-free disposable cloth. Make sure the cloth is damp and not wet.
- Wipe the glass touchscreen clean with the cloth. Do not apply cleaner directly to the interface.

### 13.2. OPTICAL PROBE (HI7641133)

#### General Maintenance

- Inspect O-ring for nicks or other damage. Replacing the o ring is advised.
- Do not substitute other grease or lubricants as it may cause the O-ring to swell.
- After long-term storage or cleaning, calibrate the probe.
- After use, rinse the probe with tap water and dry it.
- The DO cap must be kept hydrated.

## Cleaning the Smart Cap

- Use a mild detergent and a soft-bristled toothbrush to clean.
- Rinse with water after cleaning and dry with a laboratory tissue.
- Hydrate in purified water before use.

**Note:** Smart Caps need to be replaced every year.

## Smart Cap Replacement

One year after a new cap installation, the message “opdo® Cap Expired” is displayed. To maintain measurement accuracy, the Smart Cap replacement is mandatory.

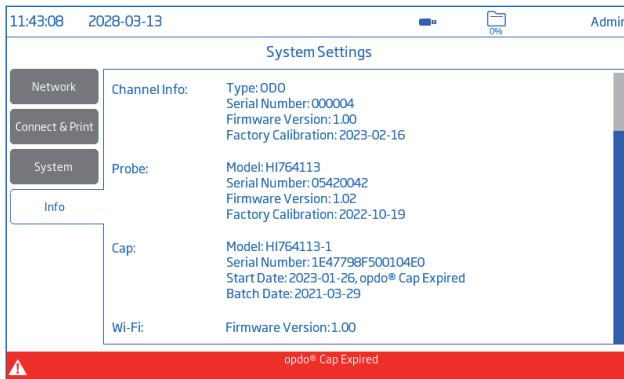
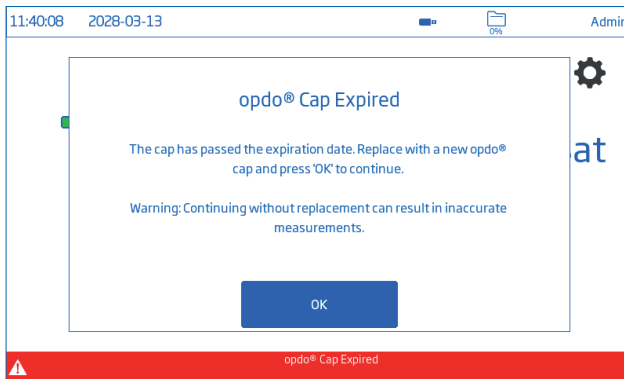

## Probe Replacement Cap Kit

The probe replacement cap kit contains: Smart Cap for opdo probe (1 pc.), sachet with silicone grease (6 g), syringe (1 pc.), lens wipe (1 pc.), certification / instruction sheet (1 pc.)

### Smart Cap Replacement Procedure

1. Turn off the meter and unplug the probe.

**Note:** Verify time and date are properly set on the meter, prior to new cap initialization.

2. Clean off the probe body and dry off with cloth.
3. Remove the expired Smart Cap from the probe by squeezing the cap at the cutout arrow and pulling it off the probe body (do not twist).
4. Remove the used O-ring by rolling it off the body.
5. Clean the O-ring groove and lens with a soft tissue followed by the lens cleaning wipe.
6. Remove the new O-ring from container and slide it on the probe tip (do not roll or twist the O-ring).
7. Use a syringe filled with silicone grease and sparingly lubricate the O-ring with a thin film of grease. Avoid getting grease or fingerprints onto the optical window.
8. Remove the new optical cap from its container and align the cutout arrow on the Smart Cap with the matching guide on the probe body.
9. Slide and press the Smart Cap onto the probe body until the cap snaps in place. Once the cap is installed, it should not be removed unless a new cap is required.

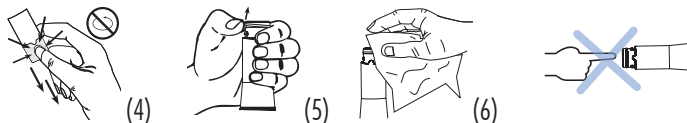

10. Place the probe in purified water to hydrate the Smart Cap before use for a minimum of 2 hours.
11. Connect the probe DIN connector to the meter DIN socket.
12. Power the meter to initiate the cap timer.
13. Calibrate.

### 13.3. POLAROGRAPHIC PROBE (HI764833)

#### General Maintenance

- Inspect membrane surface to ensure is in good condition.
- Rinse carefully with distilled or deionized water to clean.
- Damaged membranes need to be replaced.
- Verify no bubbles are trapped between the cathode and membrane.

#### Cathode Cleaning

1. Remove cap and inspect platinum cathode is bright and untarnished.  
If tarnished, clean with a clean lint-free cardboard or cloth. Gently polish off any stains.
2. Rinse the probe with deionized or distilled water.
3. Install a new membrane cap using fresh electrolyte.

**Note:** Use care when handling the probe tip.

Inspect that the insulator has not been cracked.

## Membrane Cap Replacement

**New probe:** unscrew the shipping cap and save.

**Probe in use:** unscrew the old cap.

1. Take one O-ring and one membrane cap and position the O-ring (1) in the cap (2).
2. Rinse the membrane cap with electrolyte and discard.
3. Fill the cap, above the O-ring, with electrolyte and tap the side walls to dislodge bubbles that may adhere to the threads.
4. Over a sink, with the cathode facing down, screw the cap counter clockwise until the threads are fully engaged.
5. Rinse the probe and inspect the membrane for trapped bubbles. If any, discard the electrolyte, refill, and tap the sides. Reinstall.

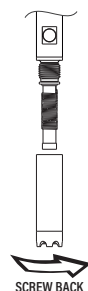
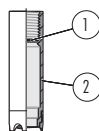

## Storage

Store with protective cap on.

## Conditioning

Before proceeding with the calibration make sure the probe is ready for measurements.

1. Reinstall the plastic protective cap over membrane end.
2. Reconnect probe to meter and allow probe to polarize.

## 14. ERROR MESSAGES

The instrument shows clear warning messages (refer to the instrument's on-display message area, bottom of the screen) when erroneous conditions appear, and when measured values are outside the expected range. The information below provides an explanation of the errors and warnings, and recommended action to be taken.

Displayed Message	Explanation & Recommended Action
DO over range	Reading is over specified measurement range i.e. <ul style="list-style-type: none"> <li>• Optical probe: above 500 % / 90 ppm (mg/L)</li> <li>• Polarographic probe: above 300 % / 45 ppm (mg/L)</li> </ul> Ensure the sample is within specified range.
Temperature under / over range	Temperature outside specified range. <ul style="list-style-type: none"> <li>• Optical probe: below <math>-5^{\circ}\text{C}</math> (<math>23^{\circ}\text{F}</math>) / above <math>50^{\circ}\text{C}</math> (<math>122^{\circ}\text{F}</math>)</li> <li>• Polarographic probe: below <math>0^{\circ}\text{C}</math> (<math>32^{\circ}\text{F}</math>) / above <math>50^{\circ}\text{C}</math> (<math>122^{\circ}\text{F}</math>)</li> </ul> Consider probe replacement if necessary.
Pressure under / over range	Below 450.0 mmHg / above 850.0 mmHg (or equivalent)
Factory calibration expired	DO and temperature calibration date older than 1 year Contact Hanna <sup>®</sup> technical support for the periodic factory calibration.
User calibration expired	Calibrate the meter.
opdo <sup>®</sup> Cap Expired	Replace the cap.

## 16. ABBREVIATIONS

CSV	Comma-Separated Values
FTP	File Transfer Protocol
GLP	Good Laboratory Practice
MTC	Manual Temperature Compensation
NBR	Nitrile Butadiene Rubber
PEI	Polyetherimide
PMMA	Polymethyl Methacrylate
PTFE	Polytetrafluoroethylene
STP	Standard Temperature and Pressure

## 17. ACCESSORIES

### DO SOLUTIONS

HI7040L	Zero oxygen solution set, 500 mL + 12 g
HI7041S	Refilling electrolyte solution, 30 mL

### OTHER ACCESSORIES

HI740036P	100 mL beaker (10 pcs.)
HI740037P	20 mL beaker (10 pcs.)
HI764080A/P	Spare membranes (5 pcs.)
HI764113-1	DO Smart Cap with O-ring
HI764113-2	Calibration / storage vessel
HI7641133	Optical DO probe (opdo <sup>®</sup> )
HI764060	Electrode holder
HI764833	Polarographic DO probe
HI900946	115 Vac to 24 Vdc power adapter, US plug
HI900947	230 Vac to 24 Vdc power adapter, European plug
HI920016	USB type A to C cable

## CERTIFICATION

All Hanna® instruments conform to the CE European Directives and UK Standards.



RoHS  
compliant



**Disposal of Electrical & Electronic Equipment.** The product should not be treated as household waste. Instead hand it over to the appropriate collection point for the recycling of electrical and electronic equipment which will conserve natural resources.

Ensuring proper product and battery disposal prevents potential negative consequences for the environment and human health. For more information, contact your city, your local household waste disposal service, or the place of purchase.

## RECOMMENDATIONS FOR USERS

Before using this product, make sure it is entirely suitable for your specific application and for the environment in which it is used. Any variation introduced by the user to the supplied equipment may degrade the controller's performance. For yours and the controller's safety do not use or store the instrument in hazardous environments.

## WARRANTY

[HI6421](#) is warranted for two years against defects in workmanship and materials when used for its intended purpose and maintained according to instructions. The [HI764833](#) polarographic probe is warranted for a period of six months. The [HI7641133](#) optical probe is warranted for two years. The [HI764113-1](#) Smart Cap is warranted for one year. This warranty is limited to repair or replacement free of charge. Damage due to accidents, misuse, tampering or lack of prescribed maintenance is not covered.

If service is required, contact your local Hanna Instruments office. If under warranty, report the model number, date of purchase, serial number (see engraved on the bottom of the meter) and the nature of the problem. If the repair is not covered by the warranty, you will be notified of the charges incurred. If the meter is to be returned to Hanna Instruments, first obtain a Returned Goods Authorization number from the Technical Service department and then send it with shipping costs prepaid. When shipping any meter, make sure it is properly packed for complete protection.

**REGULATORY NOTICES FOR THE WI-FI MODULE****United States (FCC)** FCC ID: 2ADHKATWINC1500.

This device complies with Part 15 of the FCC Rules. Operation is subject to the following two conditions: (1) this device may not cause harmful interference, and (2) this device must accept any interference received, including interference that may cause undesired operation.

**Canada (ISED)** IC: 20266-WINC1500PB

HVIN: ATWINC1500-MR210PB

PMN: ATWINC1500-MR210PB

This device complies with Industry Canada's license exempt RSS standard(s). Operation is subject to the following two conditions: (1) This device may not cause interference, and (2) This device must accept any interference, including interference that may cause undesired operation of the device. Le présent appareil est conforme aux CNR d'Industrie Canada applicables aux appareils radio exempts de licence. L'exploitation est autorisée aux deux conditions suivantes: (1) l'appareil ne doit pas produire de brouillage, et (2) l'utilisateur de l'appareil doit accepter tout brouillage radioélectrique subi, même si le brouillage est susceptible d'en compromettre le fonctionnement.

Under Industry Canada regulations, this radio transmitter may only operate using an antenna of a type and maximum (or lesser) gain approved for the transmitter by Industry Canada. To reduce potential radio interference to other users, the antenna type and its gain should be so chosen that the equivalent isotropically radiated power (e.i.r.p.) is not more than that necessary for successful communication. Conformément à la réglementation d'Industrie Canada, le présent émetteur radio peut fonctionner avec une antenne d'un type et d'un gain maximal (ou inférieur) approuvé pour l'émetteur par Industrie Canada. Dans le but de réduire les risques de brouillage radioélectrique à l'intention des autres utilisateurs, il faut choisir le type d'antenne et son gain de sorte que la puissance isotrope rayonnée équivalente (p.i.r.e.) ne dépasse pas l'intensité nécessaire à l'établissement d'une communication satisfaisante.

**Japan (MIC)** 005-101762**South Korea (KCC)** R-CRM-mcp-WINC1510MR210P**Taiwan (NCC)** CCAN18LP0321T2

注意！依據 低功率電波輻射性電機管理辦法 第十二條 經型式認證合格之低功率射頻電機，非經許可，公司、商號或使用者均不得擅自變更頻率、加大功率或變更原設計之特性及功能。第十四條 低功率射頻電機之使用不得影響飛航安全及干擾合法通信；經發現有干擾現象時，應立即停用，並改善至無干擾時方得繼續使用。前項合法通信，指依電信規定作業之無線電信。低功率射頻電機須忍受合法通信或工業、科學及醫療用 電波輻射性 電機設備之干擾。

**China (SRRC)** CMIIT ID: 2018DJ1305**ANATEL** 08497-18-08759

*Note: FCC information is marked on the bottom of the device.*