



Overhead Stirrer Multi Mixer MM-1000

Operating Manual

1.	About this edition of the manual.....	2
2.	Safety precautions.....	3
3.	General information.....	4
4.	Getting started.....	4
5.	Operation.....	6
6.	Program setting.....	7
7.	Specifications.....	9
8.	Ordering information.....	9
9.	Guarantee and service.....	10
10.	Storage and transportation.....	10
11.	Compliance.....	11

1. About this edition of the manual

1.1. The current edition of the operating manual applies to the following models:

Model	Version
MM-1000 Multi Mixer , Overhead Stirrer Multi Mixer	V.2AW

2. Safety precautions



Caution!

Make sure you have fully read and understood present manual before using the equipment. Please pay special attention to sections marked by this symbol.

2.1. General safety

- The protection provided by the equipment may be impaired if the equipment is used with accessories (stand, stirrers) not provided or recommended by the manufacturer, or used in a manner not specified by the manufacturer.
- Save the unit from shocks and falling.
- Do not use the unit if it has visible mechanical damage.
- Store and transport the unit as described in the **Storage and transportation** section.
- Before using any cleaning or decontamination methods except those recommended by the manufacturer, check with the manufacturer that the proposed method will not damage the equipment.
- Do not make modifications in design of the unit.

2.2. Electrical safety

- Connect only to the mains with voltage corresponding to that on the serial number label.
- Do not plug the unit into an ungrounded power socket, and do not use an ungrounded extension lead.
- Ensure that the power plug is easily accessible during use.
- Disconnect the unit from the mains before moving.
- If liquid penetrates into the unit, disconnect it from the mains and have it checked by a repair and maintenance technician.
- Do not operate the unit in premises where condensation can form. Operating conditions of the unit are defined in the **Specifications** section.

2.3. During operation

- Do not operate the unit in environments with aggressive or explosive chemical mixtures. Please contact manufacturer for possible operation of the unit in specific atmospheres.
- Do not operate the unit if it is faulty or has been installed incorrectly.
- Do not use outside laboratory rooms.
- Do not operate the unit without dust filters installed.
- Do not grab the unit by the stirrer.

2.4. Biological safety

- The user is responsible to carry out appropriate decontamination if hazardous material spills on or penetrates into the equipment.
- The user is responsible for decontamination of the unit before its decommissioning and utilization.

3. General information

Overhead Stirrer Multi Mixer MM-1000 is designed for stirring liquids up to 20 litres. Quiet and reliable mixer that can provide stable continuous mixing up to 7 days. It can realize three types of motion:

- Rotational
- Reciprocal
- Vibration

MM-1000 performs separate (mono-) (1; 2; 3), consecutive binary cycles (c) (1–2) × c; (1–3) × c and (2–3) × c and complex tri-cycles (1–2–3) × c.

Speed, angle and time of stirrer rotation is under microprocessor control.

Multi-mixer can be used for stirring solutions up to the “medium viscosity” range (from 1,000 to 10,000 mPa·s). It is an ideal instrument for biotechnology, organic synthesis, and analytical laboratories.

The innovative combination of three motion types provides high level of homogeneity due to consecutive combination of laminar and turbulent flows that cause substances to dissolve faster.

Electrically safe and energy efficient — powered by 12 V external power supply.

4. Getting started

- 4.1. **Unpacking.** Remove packing materials carefully and retain them for future shipment or storage of the unit. Examine the unit carefully for any damage incurred during transit. The warranty does not cover in-transit damage. Warranty covers only the units transported in the original package.



Caution!

Do not apply excessive force on the clamping chuck. When moving, hold the unit at the housing, not at the clamping chuck.

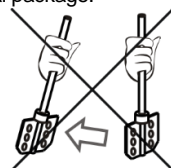

- 4.2. **Complete set.** Package contains:

4.2.1. Standard set

- MM-1000 Overhead Stirrer 1 pce.
- Rod for fixing on the support stand 1 pce.
- External power supply 1 pce.
- Operating manual 1 copy

4.2.2. Optional accessories, on request:

- Stirring element MP-1 1 pce.
- Stirring element MP-2 1 pce.
- Stirring element MP-3 1 pce.
- Stirring element MA-1 1 pce.
- Stirring element MC-1 1 pce.
- Double clamp 1 pce.
- Support stand **SRB** 1 set

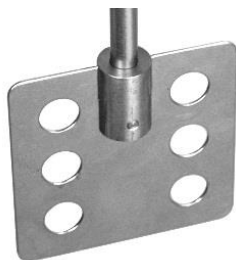

MP-1



MP-2

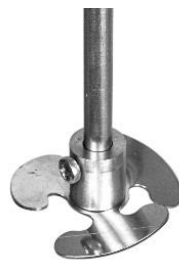

MP-3



MA-1



MC-1



Double clamp



Support stand SRB

4.3. Assembly of the optional SRB stand.

- Unpack the stand. Place the platform on a flat, stable horizontal surface.
- Using the spanner provided, remove the 10 mm nut from one of the two stand parts.
- Screw either part of the stand into the hole in the platform until it stops. Use a spanner to fix the nut to the stand thread protruding under the platform.
- Screw the second part of the stand onto the top of the first part.
- Place the rubber mat on the platform.

4.4. Setup of the appliance.

- Screw the nut (fig. 1/2) onto the threaded rod on the vertical rod (fig. 1/1).
- Screw the threaded rod (fig. 1/1) into the hole (fig. 1/4) on the rear panel of the appliance. Secure it with the nut by turning it clockwise.
- Fasten the appliance to a stand with the double clamp.
- Fix the stirring rod (fig. 1/6) in the clamp (fig. 1/5) without applying excessive transverse axial force.
- Connect the external power supply to the connector on the back of the appliance.
- Remove the protective film from the display.

5. Operation

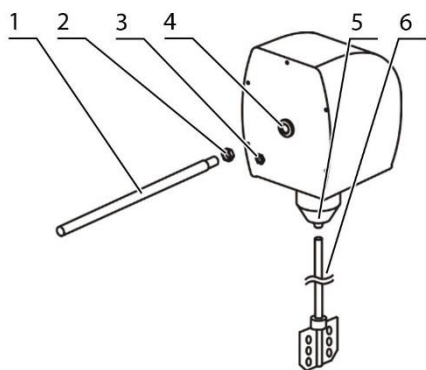

Figure 1. Assembly

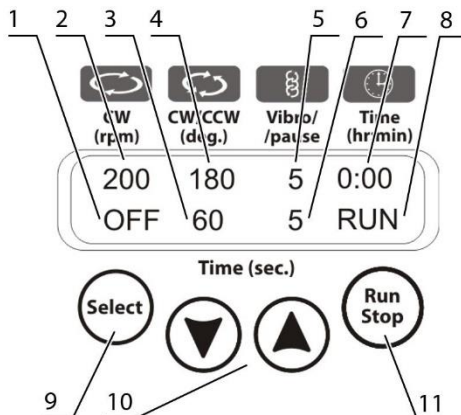

Figure 2. Control panel

- 5.1. Connect the external power supply to the mains.
- 5.2. Dip the stirrer inside the vessel with the liquid being mixed. The stirring element should be completely dipped into the liquid.
- 5.3. Turn on the red power switch on the front panel. Display shows following indications:
 - Upper line: rotation speed (fig. 2/2), reciprocation angle (fig. 2/4), vibration angle (fig. 2/5), overall timer (fig. 2/7);
 - Lower line: rotation, reciprocation and vibro timers (fig. 2/1, 2/3 and 2/6), status (STOP, fig. 2/8).
- 5.4. Set the required program and operation time (see section **Program setting**).
- 5.5. Press the **Run Stop** key (fig. 2/11) to start the program.
- 5.6. The stirrer motion will begin and the corresponding indication, RUN (fig. 2/8) and the changing time values (fig. 2/1, 2/3, 2/6 and 2/7) are be shown on the display.
- 5.7. If the overall operation time is not set and the Time indicator (fig. 2/7) shows 0:00, pressing the **Run Stop** key will start continuous operation of the unit until the Run Stop key is pressed again.
- 5.8. If the operation time is set then the unit will stop after the set time interval elapses. Flashing indication STOP (fig. 2/8) is shown on the display and a repeating sound signal for the end of operation is heard. Press the **Run Stop** key to stop the signal.
- 5.9. Press the **Run Stop** key to repeat the pre-set program.
- 5.10. The unit can be stopped at any time during operation before the set time elapses if necessary by pressing the **Run Stop** key. Pressing the **Run Stop** key again will start the program from the beginning (timer will be restarted).
- 5.11. After finishing the operation, turn off the power switch.
- 5.12. Unplug the external power supply from the mains.

6. Program setting

- 6.1. The program consists of cycles. Each cycle includes motions of three different types (rotational, reciprocating and vibro) set one after another with the duration from 0 to 250 seconds for rotational and reciprocal motion types and from 0 to 5 seconds for vibro motion.
- 6.2. **Changing parameters.** Press the **Select** key (fig. 2/9) to choose the parameter to change, each consecutive press activates the next parameter in cycle. Active parameter is flashing. Use the **▲** and **▼** keys (fig. 2/10) to set the necessary value. Pressing the key for more than 2 s increases value changing speed.
- 6.3. All parameters except overall timer can also be changed during the operation. Unit automatically saves and applies changes to the current work program.
- 6.4. Following parameters are available: rotation and reciprocation speed, reciprocation and vibro turning angle, time for each motion type and overall operation timer.
- 6.5. **Skip a motion.** If the time for a type of motion is set to zero (indication OFF), this type of motion will be skipped in the cycle.
- 6.6. **Pause.** If the turning angle for reciprocating or vibro motions is set to zero (indication 0), unit will interpret this as a pause. The stirring element will not move in this mode during the operation and the overall timer will be counted down.
- 6.7. The overall timer (fig. 2/7) is used to control the operation time. The timer can be set for the period from 1 min to 96 hours (increment 1 min). If the timer is set to 00:00, unit operates non-stop, see 5.7.
- 6.8. Table 1 shows possible motion combinations in the cycle.

Table 1. Motion type combinations

#	Rotational	Reciprocal	Vibro
1	ON	ON	ON
2	ON	OFF	ON
3	ON	Pause	ON
4	ON	OFF	OFF
5	ON	Pause	OFF
6	ON	OFF	Pause
7	ON	Pause	Pause

#	Rotational	Reciprocal	Vibro
8	ON	ON	OFF
9	ON	ON	Pause
10	OFF	ON	ON
11	OFF	Pause	ON
12	OFF	ON	Pause
13	OFF	OFF	ON
14	OFF	ON	OFF

- 6.9. Further examples illustrate program setting for both separate motions and their combinations in the cycle.

- 6.9.1. **Rotational motion.** Set the speed (40-1000 rpm, fig. 2/A) and time (1-250 s, fig. 2/B) of rotational motion. Turn off reciprocal and vibro motions by setting their motion times to zero (indications OFF, fig. 2/C and 2/D).

MM-1000 is programmed to change the direction of rotation when the motion timer is restarted, i.e. if the rotation time is set to 30 s, then the direction is changed every 30 s as shown on figure 3, where positive RPM is clockwise motion and negative - counter clockwise.

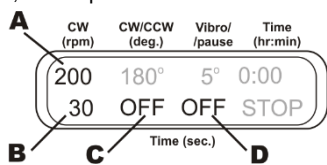

Figure 2.

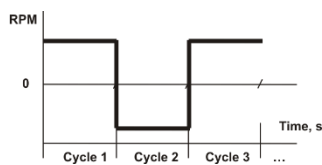

Figure 3.

- 6.9.2. **Rotational + Reciprocal + Vibro motions.** Set the speed (40-1000 rpm, fig. 4/A) and time (1-250 s, fig. 4/D) of rotational motion. Set the angle (30-360°, fig. 4/B) and time (1-250 s, fig. 4/E) of reciprocal motion. Reciprocal and rotational motions have the same speed. Set the turning angle (1-5°, fig. 4/C) and time (1-5 s, fig. 4/F) for vibro motion. Graph in figure 5 shows motion in this mode.

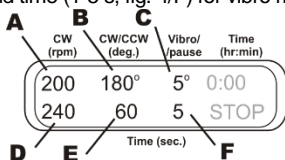

Figure 4.

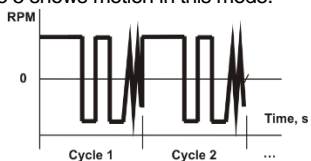

Figure 5.

- 6.9.3. **Rotational + Reciprocal motions + Pause.** Set the speed (40-1000 rpm, fig. 6/A) and time (1-250 s, fig. 6/D) of rotational motion. Set the angle (30-360°, fig. 6/B) and time (1-250 s, fig. 6/E) of reciprocal motion. Reciprocal and rotational motions have the same speed. Set the time of vibro motion to zero (fig. 6/C). Set the time of vibro motion (1-5 s, fig. 6/F) - this is the duration of pause. Graph in figure 7 shows motion in this mode.

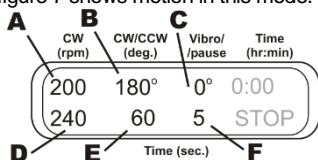

Figure 6.

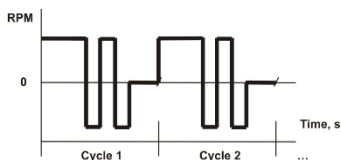

Figure 7.

- 6.9.4. **Vibro motion + Pause.** Turn off Rotational motion by setting time of rotational motion to zero (OFF, fig. 8/C). Set the turning angle of reciprocal motion to zero (fig. 8/A) and set the time for reciprocal motion (1-250 s, fig. 8/D) - this is the duration of pause. Set the turning angle (1-5°, fig. 8/B) and time (1-5 s, fig. 8/E) for vibro motion. Graph in figure 9 shows motion in this mode.

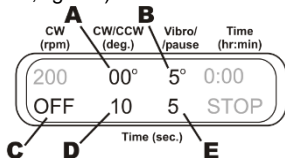

Figure 8.

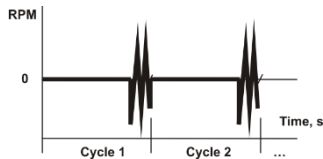

Figure 9.

7. Specifications

The unit is designed for operation in cold rooms, incubators (except CO₂ incubators) and closed laboratory rooms at ambient temperature from +4°C to +40°C in a non-condensing atmosphere and maximum relative humidity 80% for temperatures up to 31°C decreasing linearly to 50% relative humidity at 40°C.

Grant is committed to a continuous programme of improvement and reserves the right to alter design and specifications of the equipment without additional notice.

- 7.1. Rotational motion
 - 7.1.1. Speed range40–1000 rpm (increment 10 rpm)
 - 7.1.2. Timer0–250 s
- 7.2. Reciprocal motion
 - 7.2.1. Turning angle0°–360° (increment 30°)
 - 7.2.2. Timer0–250 s
- 7.3. Vibrating motion
 - 7.3.1. Turning angle0°–5° (increment 1°)
 - 7.3.2. Timer0–5 s
- 7.4. General timer of operation 1 min - 96 h (increment 1 min) / non-stop
- 7.5. Maximal stirring volume (water)20 L
- 7.6. Maximal stirring liquid viscosity 1000 mPa·s
- 7.7. Dimensions (w/out rod) 140 x 135 x 250 mm
- 7.8. Rod for fixing on the support stand, diam. x length Ø 12 mm x 260 mm
- 7.9. Stirrer shaft Ø 8 mm
- 7.10. Stirrer material.....Stainless steel (AISI 304)
- 7.11. Input current/power consumption..... 12 V, 700 mA / 8.4 W
- 7.12. External power supply input 100–240 V~, 50/60 Hz, output 12 V=
- 7.13. Weight, accurate within ±10%.....2.4 kg

8. Ordering information

- 8.1. Models and versions available:

Model	Version
MM-1000 Multi Mixer, Overhead stirrer, without accessories	V.2GW

- 8.2. To inquire about or order the optional accessories, contact manufacturer or your local manufacturer representative.

- 8.2.1. Optional accessories:

Description
MP-1, paddle stirring element, 378x(70x70)x8 mm
MP-2, propeller stirring element, 2 blades 326x55x8 mm
MP-3, propeller stirring element 3 blades 325x50x8 mm
MA-1, anchor stirring element, 332x90x8 mm
MC-1, centrifugal stirring element, 358x60(110)x8 mm
Double clamp for fixing the unit
SRB stand for unit setup, dimensions 285x375x840 mm

9. Guarantee and service

- 9.1. **Guarantee.** When used in laboratory conditions and according to this operating manual, this product is guaranteed for TWO YEARS against faulty materials or workmanship.
- 9.2. **Service.** There are no user-serviceable parts inside the unit. For all maintenance and repairs (except as defined below) return to our service department in the UK or in other countries, our distributor.
- 9.3. **Cleaning and disinfection.**
- 9.3.1. **Cleaning the outside parts.** Use mild soap and water with a soft cloth or sponge for cleaning the exterior. Rinse remaining washing solution with distilled water. Wipe dry the excess water with clean, soft cloth or sponge.
- 9.3.2. **Disinfecting the exterior plastic and metal parts.** Use 75% ethanol or DNA/RNA removing solution (e.g., PDS-250). After disinfecting it is necessary to wipe the surfaces dry.
- 9.3.3. **Autoclaving.** Stirrer elements, support stand and rods are autoclavable, 15 min / 121°C. The unit itself is not autoclavable.

10. Storage and transportation

- 10.1. Store and transport the unit in a horizontal position (see package label) at ambient temperatures between -20°C and +60°C and maximum relative humidity of 80%.
- 10.2. After transportation or storage and before connecting it to the electric circuit, keep the unit under room temperature for 2-3 hrs.
- 10.3. Extended storage of the unit does not require special procedures.

11. Compliance

EU Declaration of Conformity

All the products covered by this Manual comply with the requirements of the EU harmonised legislation verified using the following standards

Low Voltage Directive (2014/35/EC) for Electrical safety.	LVS EN 61010 Part 1 LVS EN 61010 Part 2-051
EMC directive (2014/30/EC) for Electromagnetic compatibility	LVS EN 61326-1
RoHS Directive (Directive 2011/65/EC including 2015/863) for Hazardous substances	LVS EN 50581

UK Declaration of Conformity

All the products covered by this Manual comply with the requirements of UK statutory requirements verified using the following standards.

Electrical Equipment (Safety) Regulations 2016	BS EN 61010 Part 1 BS EN 61010 Part 2-051
Electromagnetic Compatibility Regulations 2016	BS EN 61326-1
The Restriction of the Use of Certain Substances in Electrical and Electronic equipment Regulations 2012	BS EN 50581

Waste Electrical and Electronic Equipment (WEEE)



All the products covered by this Manual are marked with the crossed-out wheellie bin symbol indicating they must not be disposed of with unsorted waste. Safe recycling of WEEE helps conserve natural resources and protect human health.

Grant Instruments complies fully with the UK Waste Electrical & Electronic Equipment (WEEE) regulations 2013. We are a member of the B2B compliance scheme (Scheme Approval Number WEE/MP3338PT/SCH), which handle our WEEE obligations on our behalf. Grant Instruments have been issued with a unique registration number by the Environmental Agency, this reference number is WEE/GA0048TZ.

For information regarding WEEE collections in the UK please contact our B2B Compliance Scheme directly on 01691 676 124 or www.b2bcompliance.org.uk

In the EU, Grant Instruments complies with WEEE Directive 2012/19/EU.

Contact your local equipment supplier for WEEE collections.

REACH Regulations

This product does not contain any Substances of Very High Concern (SVHCs) at greater than 0.1% that have to be identified in accordance with Regulation (EC) No 1907/2006 and therefore does not have an entry in the SCIP database.

Grant-bio

**Grant Instruments
(Cambridge) Ltd**

Shepreth

Cambridgeshire

SG8 6GB

UK

Tel: +44 (0) 1763 260811

Email: salesdesk@grantinstruments.com

www.grantinstruments.com

Representative in the European Union

Grant Instruments Europe B.V

Strawinskylaan 411

WTC, Tower A, 4th Floor

1077 XX Amsterdam

The Netherlands

Email: grant@eu.grantinstruments.com