

Laboratory & Industrial Ovens & Furnaces

LEADING HEAT TECHNOLOGY





SCIENCE FOR SOLIDS

HEAT TREATMENT
ELEMENTAL ANALYSIS
MATERIALOGRAPHY &
HARDNESS TESTING
MILLING & SIEVING
PARTICLE CHARACTERIZATION

As part of the VERDER Group, the business division VERDER SCIENTIFIC sets standards in the development, manufacture and sales of laboratory and analytical equipment. The instruments are used in the areas of quality control, research and development for sample preparation and analysis of solids.

Leading Heat Technology

The Carbolite Gero brand is synonymous with high quality, leading heat technology in the design and manufacture of laboratory and industrial ovens and furnaces ranging from 30°C to 3000°C and sold globally to over 100 countries.

On 1st January 2016 Carbolite (UK) and Carbolite Gero (Germany) joined to become one company under the name of Carbolite Gero. With the combined product lines the company will strengthen its market position locally and globally. In the past, both companies gained strong, established reputations for engineering expertise in applied heating technology.

Carbolite Gero has two manufacturing and sales sites. One is based in Derbyshire, United Kingdom, where Carbolite has been manufacturing laboratory and industrial ovens and furnaces up to 1800°C since 1938; the second facility is located in Neuhausen, southern Germany, where high temperature furnaces up to 3000°C with a large variety of solutions for vacuum and other modified atmospheres have been manufactured since 1982.

In addition to the wide range of standard products as shown in this catalogue, Carbolite Gero is an expert in the development of customized equipment for complex heat treatment processes. Solving customers' individual application requirements has given Carbolite Gero an important place in aerospace, engineering, materials science, heat treatment, medical, bioscience and contract testing laboratories globally to name a few. Not only can Carbolite Gero supply products with Standards-compliant furnace and oven designs (eg, Nadcap heat treatment processes (AMS2750F)), but also fully traceable certification for control, measurement, recording and data acquisition devices, issued by an independent UKAS accredited laboratory.

All products, and more, featured in this catalogue are available through your local Carbolite Gero office or an extensive network of dealers and local sales organisations.

www.carbolite-gero.com



Laboratory & Industrial Ovens up to 700°C

Products in this section include both laboratory and industrial ovens with maximum operating temperatures up to 700°C.

	Model	up to	Page
Ovens Selection Guide			
			12
Laboratory Ovens			
Laboratory Bench Mounted Ovens	AX	250°C	13
Natural Convection Ovens	PN	300°C	14
Fan Convection Ovens	PF	300°C	15
High Temperature Bench Mounted Ovens	LHT	600°C	16
Industrial Ovens			
General Purpose Ovens	GP	300°C	17
Rapid Cooling Ovens	TLD	400°C	18
High Temperature Industrial Ovens	HT	600°C	19
Large General Purpose Ovens	LGP	700°C	20
Atmosphere Controlled Ovens			
High Temperature Modified Atmosphere Ovens	HTMA	700°C	22
Clean Room Ovens			
Clean Room Ovens	CR	250°C	23
High Temperature Clean Room Ovens	HTCR	600°C	24



Disclaimer

As Carbolite Gero has a policy of continuous product development, improvements and changes will be made during the lifetime of this catalogue. Carbolite Gero reserves the right to amend the specifications at any time and in any particular way without prior notice provided that the ultimate performance of the equipment is not reduced by such action.

If the dimensions or technical specification of a product in this catalogue are critical, it is important that Carbolite Gero is contacted to confirm the details prior to order placement.

Laboratory & Industrial Chamber Furnaces up to 1800°C

Products in this section include an extensive range of chamber furnace with maximum operating temperatures up to 1800°C. Application specific equipment includes the ranges of ashing and annealing furnaces.

	Model	up to	Page
Chamber Furnaces Selection Guide			
			28
Laboratory Chamber Furnaces			
Economy Chamber Furnaces	ELF	1100°C	29
Standard Chamber Furnaces	CWF	1300°C	30
Burn-off Chamber Furnaces	CWF-B	1200°C	30
Chamber Furnaces with Balance	CWF-BAL	1100°C	30
CWF retorts	CWF	1100°C	32
Air Recirculating Furnaces	HRF	750°C	33
Rapid Heating Chamber Furnaces	RWF	1200°C	34
Top Loading Chamber Furnaces	VCF	1200°C	35
High Temperature Chamber Furnaces	RHF	1600°C	36
High Temperature Bottom Loading Furnaces	BLF	1800°C	38
High Temperature Laboratory Chamber Furnaces	HTF	1800°C	39
Industrial Chamber Furnaces			
High Temperature Industrial Chamber Furnaces	HTF	1800°C	40
General Purpose Chamber Furnaces	GPC	1300°C	41
GPC A107 retorts	GPC	1300°C	42
Modified Atmosphere Chamber Furnaces	GPCMA	1200°C	44
Annealing Furnaces	GLO	1100°C	46
Top Hat Furnaces	HB	1800°C	48
Large Chamber Furnaces	LCF	1400°C	50
Static or Bogie Hearth Chamber Furnaces	SBCF	1100°C	51
Ashing Furnaces Selection Guide			
			52
Ashing Furnaces			
Standard Ashing Furnaces	AAF	1200°C	53
Ashing Furnace with Balance	AAF-BAL	1100°C	55
Specialist Ashing Furnaces	GSM	1100°C	56
Afterburner Ashing Furnaces	ABF	800°C	57
Asphalt Binder Analyser	ABA	750°C	58

Horizontal & Vertical Tube Furnaces up to 1800°C

Products in this section include an extensive range of tube furnaces with maximum operating temperatures up to 1800°C. The range of tube furnaces includes horizontal and vertical, single and 3-zone models as well as models specifically for use under vacuum.

	Model	up to	Page
Tube Furnaces Selection Guide			
Universal Tube Furnaces			
NEW	Mini, Small, Medium Tube Furnaces	TF1, TF3	1200°C 66
NEW	Small, Medium Tube Furnaces, 1600°C	TF1, TF3	1600°C 78
NEW	Horizontal and Vertical Tube Furnaces	FHA, FHC	1350°C 74
	High Temperature Horizontal Tube Furnaces	HTRH	1800°C 80
	High Temperature Vertical Tube Furnaces	HTRV	1800°C 82
Split Tube Furnaces			
NEW	Small, Medium, Large Split Tube Furnaces	TS1, TS3	1200°C 70
NEW	Horizontal and Vertical Split Tube Furnaces	FST, FZS	1200°C 76
	High Temperature Vertical Split Tube Furnaces	HTRV-A	1700°C 84
	Rotating Horizontal Split Tube Furnaces	TSR	1150°C 89
	Rotary Reactor Tube Furnaces	TSO	1100°C 90
Gradient Tube Furnaces			
NEW	Compact Gradient Split Tube Furnaces	TG2, TG3	1200°C 88
Special Application Furnaces			
	Coal and Coke Test Equipment		92
	Cupellation Furnaces	CF	1200°C 94
	Carbon-14 and Tritium Furnaces	MTT	1200°C 95
	Vacuum, Inert and Reactive Gas Furnaces		3000°C 96
	Custom Designed Ovens & Furnaces		1800°C 97

Product Configurations

All Carbolite Gero products are fitted with a controller from a sophisticated range of temperature controllers and optional data loggers. Tube furnaces often require additional work tubes and accessories for use with modified atmosphere and vacuum. Chamber furnaces can also be used with modified atmosphere by fitting a retort. Detailed information on these options as well as power supply information can be found on the following pages.

Product Configurations	
Temperature Control Options	100
Work Tube Selection Guide	106
Work Tube Packages	107
Work Tube Accessories	110
Vacuum Pump Packages for Tube Furnaces	112
NEW Inert gas packages	113
Laboratory Gas Safety System	114
Gas Safety System for hydrogen from RT	115
Modified Atmosphere Options	116
Accessories	
	118
Power Supply Information	
	120
Index	
	124



Manufactured at Carbolite Gero Hope



Manufactured at Carbolite Gero Neuhausen

Temperature

Temperature is a measure of the heat or kinetic energy of the particles within a substance.

There are three primary mechanisms of heat transfer: convection, conduction and radiation. All three mechanisms occur within Carbolite Gero products.

In **convection** heat transfer occurs by the movement of gases or liquids. The movement occurs within a fluid or gas by the tendency of hotter, and therefore less dense, material to rise, and colder denser material to sink under the influence of gravity. This results in transfer of heat. Most Carbolite Gero products contain an atmosphere of air or another gas and heat will be transferred within the atmosphere by convection. The graph shows that convection is the dominant heat transfer mechanism below 700°C. Carbolite Gero ovens work in the temperature range up to 700°C and often use fans to mix the atmosphere to improve the temperature uniformity within the working chamber.

Conduction is the process by which heat is directly transmitted through the material of a substance when there is a difference of temperature between adjoining regions. Different materials have different heat conductance which is a measure of their heat conduction. Carbolite Gero often uses thermal insulation material with extremely low heat conductance to contain heat within the working chamber.

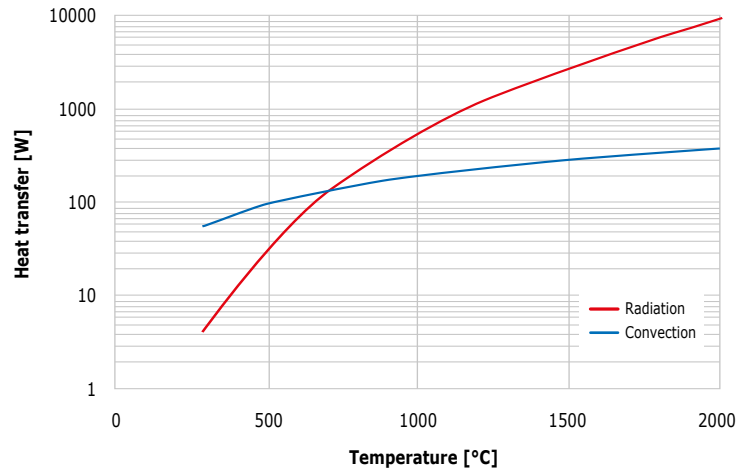

Radiation is the emission of energy as electromagnetic waves. Radiation can pass through a gas atmosphere or a vacuum, but not through a solid. From the graph we can see that radiation is the dominant heat transfer mechanism above 700°C. Carbolite Gero furnaces are designed for radiant heat transfer where chamber design, location of heating elements and use of thermal insulation techniques are critical for superior performance. Because radiation cannot pass through a solid Carbolite Gero utilises radiation shields as a thermal insulation technique. An example of this is the application of radiation shields in a tube furnace, or the radiation shield in a Carbolite Gero metallic vacuum furnace.



Atmosphere

A critical factor in the use of Carbolite Gero products is the determination of the atmosphere required for a heat treatment process. The table below provides an overview of product type, its heating element material and the type of atmospheres or vacuum in relation to the temperature range. For gas tight ovens below 700°C modified atmospheres are available but vacuum is not possible.

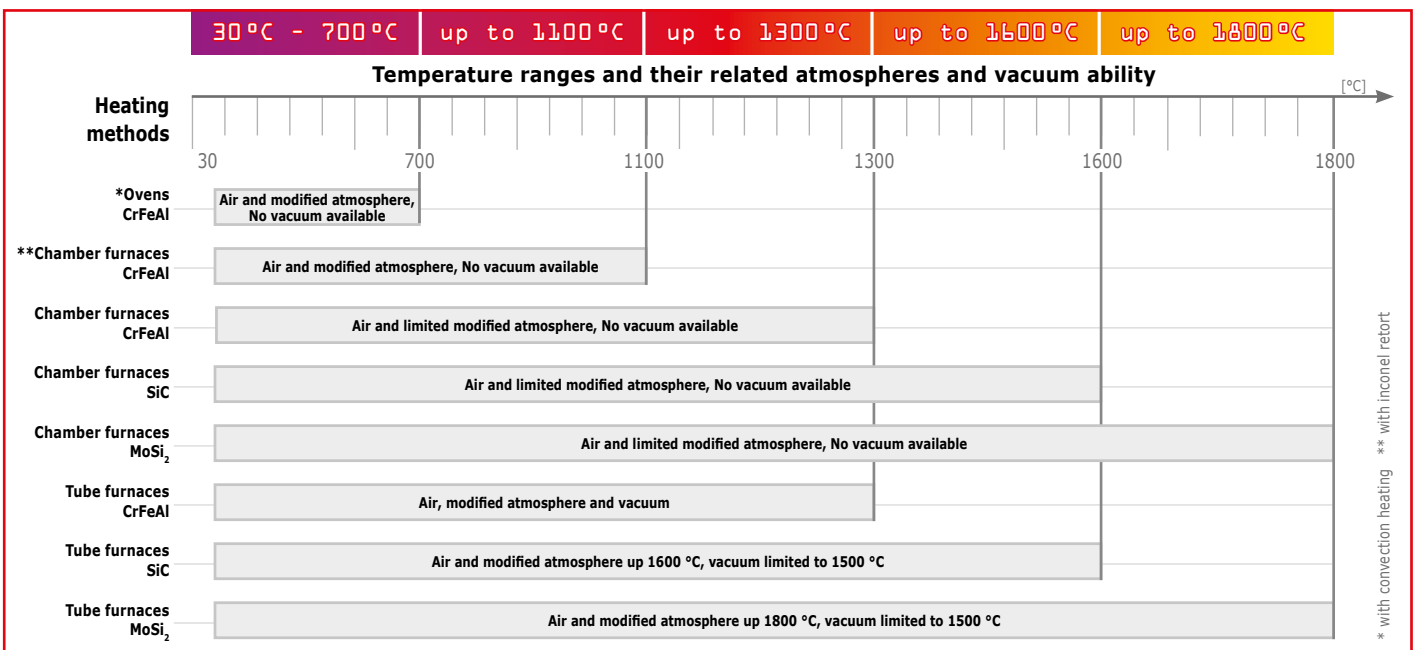
Chamber furnaces up to 1800°C are not gas tight so the control of the atmosphere is limited and vacuum is not possible. In these products gas tight retorts are required to achieve modified atmosphere such as oxygen, nitrogen, argon, hydrogen or formation gas up to 1100°C (see pages 32 & 43). Tube furnaces can be used with work tube packages to provide vacuum up to 1500°C and modified atmospheres up to 1800°C.



Application Matrix

-  specially suited for
-  limited suitability
- not suited for
- * requires additional option

		Application																	
		Ashing/calcination/ LOI/burn-off	Sintering	Pyrolysis	Transport reactions (including CVD)	Hardening / tempering	Melting	Materials testing	Tensile testing	Thermocouple calibration	Annealing / stress relieving	Drying / moisture extraction*	Stoving & curing*	Clean room applications	Precious metals applications	Coal assay including ash fusibility	Asphalt binder analysis	Dental	Carbon-14 & tritium

Ovens (see pages 10-25)

Models

Temperature Range	Models	Ashing/calcination/ LOI/burn-off	Sintering	Pyrolysis	Transport reactions (including CVD)	Hardening / tempering	Melting	Materials testing	Tensile testing	Thermocouple calibration	Annealing / stress relieving	Drying / moisture extraction*	Stoving & curing*	Clean room applications	Precious metals applications	Coal assay including ash fusibility	Asphalt binder analysis	Dental	Carbon-14 & tritium
up to 600 °C	AX, PN, PF GP, LGP, LHT, HT, HTMA				-		-		-	-				-	-	-	-	-	-
	CR, HTRC	-	-	-	-		-		-	-			-		-	-	-	-	-
	TLD	-	-	-	-		-		-	-			-	-	-	-	-	-	-

Chamber Furnaces (see pages 26-59)

Temperature Range	Models	Ashing/calcination/ LOI/burn-off	Sintering	Pyrolysis	Transport reactions (including CVD)	Hardening / tempering	Melting	Materials testing	Tensile testing	Thermocouple calibration	Annealing / stress relieving	Drying / moisture extraction*	Stoving & curing*	Clean room applications	Precious metals applications	Coal assay including ash fusibility	Asphalt binder analysis	Dental	Carbon-14 & tritium
up to 750 °C	ABA		-	-	-	-	-		-	-	-	-	-	-	-	-	-		-
up to 1300 °C	ELF			-	-		-		-	-		-	-	-	-	-	-	-	-
	HRF	-		-	-		-		-	-			-	-	-	-	-	-	-
	CWF, RWF, GPC, LCF, SBCF				-				-	-		-	-	-	-	-	-	-	-
	GLO	-		-	-		-		-	-		-	-	-	-	-	-	-	-
	AAF, AAF-BAL, CWF-B, CWF-BAL, GSM, ABF				-		-		-	-		-	-	-	-	-	-	-	-
	VCF				-	-			-	-		-	-	-	-	-	-	-	-
up to 1400 °C - 1800 °C	RHF, HTF			-	-				-	-		-	-	-	-	-	-	-	-
up to 1300 °C - 1800 °C Bottom loading/top hat furnaces	BLF, HB				-				-	-		-	-	-	-	-	-	-	-

Tube Furnaces (see pages 60-97)

Temperature Range	Models	Ashing/calcination/ LOI/burn-off	Sintering	Pyrolysis	Transport reactions (including CVD)	Hardening / tempering	Melting	Materials testing	Tensile testing	Thermocouple calibration	Annealing / stress relieving	Drying / moisture extraction*	Stoving & curing*	Clean room applications	Precious metals applications	Coal assay including ash fusibility	Asphalt binder analysis	Dental	Carbon-14 & tritium
up to 1350 °C Single zone	FHA, FST												-	-	-	-	-	-	-
up to 1350 °C 3-zone	FHC, FZS												-	-	-	-	-	-	-
up to 1600 °C Single zone	TF						-					-	-	-	-	-	-	-	-
up to 1600 °C 3-zone	TF						-					-	-	-	-	-	-	-	-
up to 1700 °C - 1800 °C Single zone	HTRH, HTRV, HTRV-A						-					-	-	-	-	-	-	-	-
up to 1700 °C - 1800 °C 3-zone	HTRH-3						-					-	-	-	-	-	-	-	-
up to 1100 °C - 1200 °C Single zone rotating tube furnace	TSO, TSR				-	-	-		-	-	-	-	-	-	-	-	-	-	-
up to 1100 °C - 1200 °C 3-zone rotating tube furnace	TSR				-	-	-		-	-	-	-	-	-	-	-	-	-	-

Application Specific Furnaces (see pages 92-97)

Temperature Range	Models	Ashing/calcination/ LOI/burn-off	Sintering	Pyrolysis	Transport reactions (including CVD)	Hardening / tempering	Melting	Materials testing	Tensile testing	Thermocouple calibration	Annealing / stress relieving	Drying / moisture extraction*	Stoving & curing*	Clean room applications	Precious metals applications	Coal assay including ash fusibility	Asphalt binder analysis	Dental	Carbon-14 & tritium
	CAF G5	-	-	-	-	-	-	-	-	-	-	-	-	-	-	-		-	-
	CF, SCF		-	-	-	-	-	-	-	-	-	-	-	-		-	-	-	-
	MTT					-	-		-		-	-	-	-	-	-	-	-	
	PTC	-	-	-	-	-	-	-		-	-	-	-	-	-	-	-	-	-

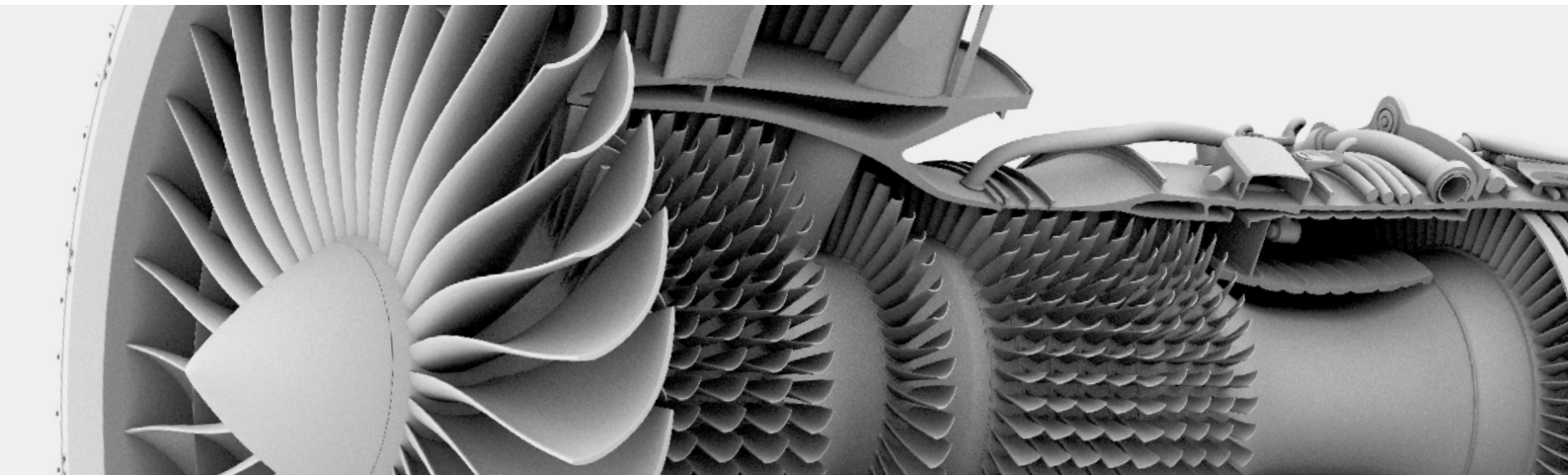

Carbolite Gero's Expertise in Pyrometry and the Application of AMS2750F

Created by the Performance Review Institute, the Nadcap programme is designed to provide an accreditation and quality assurance framework for a defined range of 'special processes and products' that are used within the Aerospace and Defence sectors. It was originally sponsored by Boeing and is now adopted by all Western aerospace manufacturers.

Nadcap is becoming increasingly important in the aerospace sector with accreditation frequently being requested by companies such as: GE Aviation, Rolls Royce plc, MTU, Snecma, Turbomeca, Boeing, Vought Aircraft Industries, Bombardier, Honeywell,

Hamilton Sundstrand and Sikorsky Aircraft.

Manufacturers and end users must follow the requirements of the SAE Aerospace Standard Number AMS2750F. In this Standard ovens and furnaces are classified by their temperature uniformity and the type of control instrumentation that they use.

Carbolite Gero has significant expertise in supplying aerospace customers with ovens and furnaces designed for full Nadcap compliance.

Some examples are shown on the following pages identified by this AMS icon.



What is Nadcap?

National Aerospace and Defence Contractors Accreditation Programme

A quality system for aerospace manufacturers and subcontractors controlled through audited standards.

Other standards aligned within Nadcap

- Aerospace Standard AS7102 Ref A
- Audit Control AC 7102 Rev B
- Rolls Royce standard RPS 953 issue 12

For product to conform with AMS2750F the following have to be defined:

1. Temperature range of compliance
2. Class of temperature uniformity required – either Class 1, 2, 3, 4, 5 or 6
3. Temperature Instrumentation type – either Type A, B, C, D, D+ or E – see diagram on the next page
4. Uniform zone required – define H x W x D
5. Temperature Uniformity Survey (TUS) required either with charge or empty chamber
6. System Accuracy Test (SAT) requirements

Class	Uniformity
1	±3°C
2	± 5°C or ± 6°C
3	± 7°C or ± 8°C
4	±10°C
5	±14°C
6	±28°C

For class 1 uniformity, ±3°C, the size of an oven chamber needs to be significantly larger than the working volume. If a working volume of 600 mm x 600 mm x 600 mm is required we recommend a chamber volume of at least 800 mm x 800 mm x 800 mm.

Product instrumentation 'Type'

Control instrumentation type is defined as Type A, B, C, D, D+ or E. The differences between these types are shown in the diagram below and relate to the number of recording thermocouples permanently installed in the work-space and the instrumentation used to monitor these.

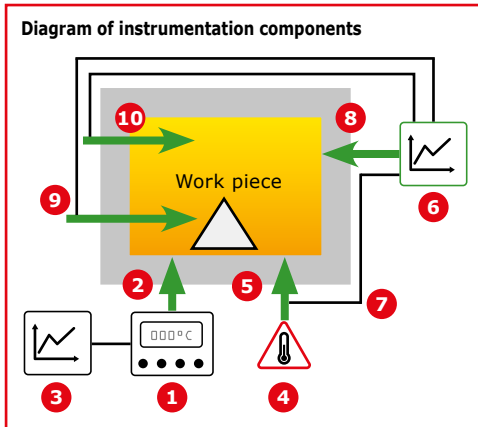

Instrumentation components		Type A	Type B	Type C	Type D	Type D+	Type E
1	Control instrument with temperature display	X	X	X	X	X	X
2	Control sensor	X	X	X	X	X	X
3	Control instrument recorder	X	X	X	X	X	
4	Over-temperature protection instrument	X	X	X	X	X	
5	Over-temperature protection sensor	X	X	X	X	X	
6	Multipoint chart recorder (or separate channel in control instrument recorder)	X	X	X			
7	High temperature protection sensor connected to multipoint recorder	X		X			
8	Low temperature sensor connected to multipoint recorder	X		X			
9	Load sensor connected to multipoint recorder	X	X				
10	Recording sensor(s) per zone.					X	

Examples of products built to comply with AMS2750F

Model	Page	Max temp. (°C)	Temp. uniformity ± (°C)	AMS2750F uniformity class	AMS2750F instrument. type
PF800	15	250	5	2	D
PF200	15	300	5	2	D
PF60	15	300	5	2	B
PF200	15	250	5	2	D
GP450A	17	300	10	4	D
GP450A	17	300	5	2	D
GP220B	17	250	6	2	B
LGP2/935	20	250	6	2	C
LGP2/1212	20	250	6	2	A
LGP2/1750	20	250	5	2	C
LGP4/1419	20	425	6	2	A
LGP6/1180 S&C	20	625	10	4	B
LGP6/1750	20	625	5	2	C
LGP6/2700	20	625	6	2	D
HT4/220	19	400	6	2	D
HT5/95	19	500	14	5	B
HT5/350	19	500	6	2	C
HT6/220	19	600	6	2	A
HRF 7/45B	45	750	6	2	D
HRF 7/45	45	750	5	2	D
CWF 12/36	30	1200	10	4	D
CWF 13/65	30	1300	6	2	D
GPC 12/131	39	750	5	2	D
LCF 14/350	42	1400	8	3	D
LCF 12/560	42	1200	6	2	B

AMS2750F uniformity data for the LGP oven range

Model size	Uniform Volume [mm]			
	CLASS 1 (±3°C)	CLASS 2 (±6°C)	CLASS 3 (±8°C)	CLASS 4 (±10°C)
500	500x500x500	600x600x600	625x625x625	650x650x650
730	600x600x600	700x700x700	725x725x725	750x750x750
1000	700x700x700	750x750x750	825x825x825	850x850x850
1500	1200x700x700	1250x750x750	1300x825x825	1300x850x850
1750	900x900x900	950x950x950	1025x1025x1025	1050x1050x1050
2160	1200x900x900	1250x950x950	1325x1025x1025	1350x1050x1050
3370	1100x1100x1100	1200x1200x1200	1225x1225x1225	1250x1250x1250

LGP 2: Operate at a maximum temperature of 250°C
Temperature Spread:
CLASS 1: 150°C - 250°C one temp only between this range
CLASS 2, 3 & 4: 150°C - 250°C -> Two points between this range

LGP 4: Operate at a maximum temperature of 425°C
Temperature Spread:
CLASS 1: 250°C - 425°C one temp only between this range
CLASS 2, 3 & 4: 250°C - 425°C -> Two points between this range

LGP 6: Operate at a maximum temperature of 625°C
Temperature Spread:
CLASS 1: 425°C - 625°C one temp only between this range
CLASS 2, 3 & 4: 425°C - 625°C -> Two points between this range

Laboratory & Industrial Ovens up to 700 °C



Ovens	Models	Page
Ovens Selection Guide		12
Laboratory Ovens	AX, PN, PF, LHT	13
Industrial Ovens	GP, TLD, HT, LGP	17
Atmosphere Controlled Ovens	HTMA	22
Clean Room Ovens	CR, HPCR	23

As discussed in the Physics of Heat (page 6) Carbolite Gero defines ovens as operating up to 700°C, where heat transfer is predominantly by convection (as shown right).

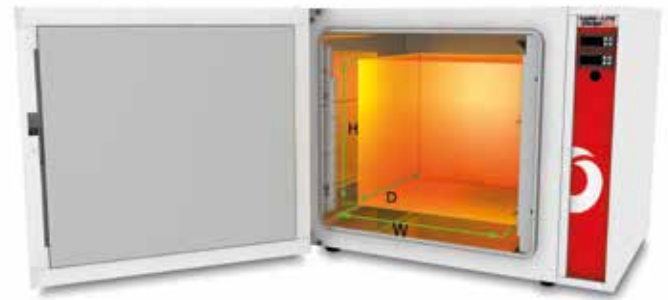

Carbolite Gero's design features optimised uniform volume

Factors to consider when selecting an oven:

What temperature?

- Carbolite Gero offers several ranges of ovens with different maximum operating temperatures from maximum temperatures of 250°C to as high as 700°C with minimum working temperatures of ambient +30°C to +60°C
- Ovens are suitable for use at their maximum operating temperature.

What size?

- Carbolite Gero's smallest bench mounted oven has a capacity of 30 litres, but larger standard volume ovens up to 14,000 litres are available.
- The uniform volume of an oven is smaller than the total volume due to the heat losses through the walls and door.

Natural or fan convection?

- Simple ovens do not have a fan fitted, but have elements mounted in the chamber base. Air circulates by convection; the warmed air at the base initially rises then falls as it cools. The resulting slow airflow is preferable, for example, for processes involving powders which may be disturbed by fan convection or where there is a risk of cross contamination between samples.

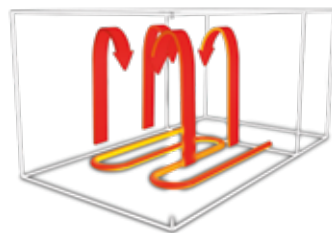

- In fan convection ovens the elements are located on the side of the oven and on smaller ovens the fan blows air through an air-guide, over the heating elements and around the chamber. On larger ovens, where there is room for a more complex air guide, the fan pulls air over the elements. The fan action thoroughly mixes the heated air, equalising its temperature before blowing it around the chamber and over the sample. This provides a uniform volume within the oven chamber for applications that require a specific temperature uniformity (the image top right shows a typical optimised uniform zone h x w x d).



Advantages of fan convection

- Ovens heat up and recover the temperature more quickly
- The higher airflow improves the contact between the sample/load and as a result the sample/load also heats up faster
- The airflow conveys the heat to the temperature sensor more quickly, resulting in improved control stability
- The temperature uniformity is improved
- The fan promotes higher airflow in and out of the chamber and speeds up drying by faster removal of vapour (water or solvents – see additional note regarding the use of solvents in ovens)
- Variable speed fans are also offered which can be a solution to the problem of disturbing the samples/ cross contamination

Exhaust options

Exhaust fan – an extraction unit is fitted to the oven and is provided with an on/off switch. Suitable for use in applications creating large amounts of fumes which need to be extracted from the oven.

Moisture extraction (MEO) – this option makes the oven suitable for drying processes which contain a lot of moisture. It includes the air exhaust fan option, plus the addition of sealing the chamber seams to prevent moisture from entering the insulation.

Stoving and curing – designed for use with paints, resins and solvents, this option can remove small quantities of volatile solvents from the chamber. It includes the air exhaust fan and sealing of the chamber seams. An airflow failure sensor cuts heating if the exhaust system is not working effectively. An explosion relief panel is also added: a section of the chamber lining and the outer case are replaced with a lightweight thermal insulation panel which is covered with aluminium foil; in the event of an explosion this panel is harmlessly pushed out of the oven to release the pressure. Electronic over-temperature protection is fitted as standard with this option. The fitting of the stoving and curing option enables ovens to meet the requirements of BS EN 1539 : 2015 'Dryers and ovens, in which flammable substances are released – safety requirements'.

NOTE: This option is suitable for small amounts of solvent only – please consult Carbolite Gero regarding your application before ordering this option.



AX – Laboratory Bench Mounted Ovens

The Apex AX range of 250°C laboratory ovens, comprises three bench mounted models equipped with the R38 digital PID temperature controller.



AX 60

AX 30

Standard features

- 250°C maximum operating temperature
- Equipped with the R38 digital PID temperature controller as standard
- 30, 60 or 120 litre chamber volumes
- Fan convection for rapid heating & excellent uniformity
- Chemically resistant stainless steel liner
- Two adjustable nickel-chrome plated wire shelves
- Lever latch door & airtight silicone seal
- Built to comply with BS EN 61010-2-010:2003

Options (specify these at time of order)

- Over-temperature protection (recommended to protect valuable contents & for unattended operation)
- Digital countdown timer to switch oven off
- Additional sets of shelves & runners
- Lockable door
- Low voltage options for use below 220 V
- Routine spares kit
- Oven stacking frame

Technical data

CGH Model	Max. temp. [°C]	Temperature uniformity [°C]	Heat-up time [mins]	Recovery time [mins]	Dimensions: Internal H x W x D [mm]	Dimensions: External H x W x D [mm]	Shelves fitted / accepted	Shelf loading each / total [kg]	Volume [litres]	Air changes / hr	Max. power [W]	Holding power [W]	Weight [kg]
AX 30	250	±5.0 @ 250°C	23	3	295 x 300 x 320	440 x 590 x 465	2 / 4	10 / 20	28	65	1000	342	24
AX 60	250	±5.0 @ 250°C	25	3	395 x 400 x 420	540 x 690 x 565	2 / 6	10 / 30	66	28	1500	465	37
AX 120	250	±5.0 @ 250°C	26	3	495 x 500 x 520	640 x 790 x 665	2 / 8	10 / 40	128	14	2000	622	55

i Please note:

- Minimum operating temperature approximately ambient plus 30°C
- Uniformity is measured in an empty chamber with vents closed, after a stabilisation period
- Maximum power and heat up time based on a 240 V supply
- Shelf loadings are based on evenly distributed weight
- External dimensions with door closed
- The uniform volume is smaller than the total chamber volume



PN – Natural Convection Ovens

The Peak range 300°C laboratory ovens are available in both PN natural convection and in the PF fan convection models. All PN models are bench mounted.

In the PN ovens air circulation depends upon natural convection. The resulting slow airflow is preferable, for example, for processes involving powders which may be disturbed by fan convection or where there is a risk of cross contamination between samples.

The reduced complexity makes natural convection a less expensive option.



PN 60 with 301 controller option

Standard features

- 300 °C maximum operating temperature
- R38 PID controller (see below for other controller options)
- Economical natural convection models
- Chemically resistant stainless steel liner
- Two nickel-chrome plated wire shelves
- Lever latch door & airtight silicone seal
- Compliant with safety standard BS EN 61010-2-010:2003

Options (specify these at time of order)

- A range of sophisticated digital controllers, multisegment programmers and data loggers with digital communication options is available (see page 100)
- Over-temperature protection (recommended to protect valuable contents & for unattended operation)
- Access port for independent thermocouple
- Accessory shelves & runners
- Cable access ports
- Viewing window
- Interior light
- Stacking frame
- Lockable door
- Door interlock activated by temperature alarm relay or program segment output (EPC3016, EPC3008 or nanodac)
- Door switch to isolate elements
- Floor stands & wheeled trolleys
- Routine spares kit

Heavy duty options

Model	Reinforced base	Heavy duty shelves	
	Max. weight [kg]	Max. quantity	Max. weight / shelf [kg]
PN 30	40	2	20
PN 60	60	3	20
PN 120	80	3	25
PN 200	100	4	25

Please note: Reinforced base, shelf runners and shelves supplied as a package

Technical data

CGH	Max. temp. [°C]	Temp. stability [°C]	Temperature uniformity [°C]	Heat-up time [mins]	Recovery time [mins]	Dimensions: Internal H x W x D [mm]	Dimensions: External H x W x D [mm]	Shelves fitted / accepted	Shelf loading each / total [kg]	Volume [litres]	Max. power [W]	Holding power [W]	Weight [kg]
PN 30	300	±0.5	±7.0 @ 300°C	52	8.5	255 x 330 x 320	470 x 665 x 470	2 / 3	10 / 20	27	750	300	37
PN 60	300	±0.5	±7.0 @ 300°C	52	8.5	350 x 392 x 420	570 x 765 x 570	2 / 5	10 / 30	57	1000	480	55
PN 120	300	±0.5	±7.0 @ 300°C	52	8.5	450 x 492 x 520	670 x 865 x 670	2 / 9	10 / 40	115	1500	720	74
PN 200	300	±0.5	±7.0 @ 300°C	58	10	700 x 592 x 520	920 x 965 x 670	2 / 15	10 / 50	215	2250	1160	96

Please note:

- Minimum operating temperature approximately ambient plus 30°C
- Uniformity is measured in an empty chamber with vents closed, after a stabilisation period
- Maximum power and heat up time based on a 240 V supply

- Shelf loadings are based on evenly distributed weight
- External dimensions with door closed
- Temperature uniformity is smaller than the total chamber volume



PF – Fan Convection Ovens

The Peak range 300°C laboratory ovens are available as both PF fan convection and PN natural convection models.

Fan convection provides greater temperature uniformity and faster recovery rates than natural convection.

Standard features

- 300°C (PF 30 to PF 200) or 250°C (PF 400, PF 800) maximum operating temperatures
- R38 PID controller (PF 30 to PF 200). Carbolite Gero 301 controller with single ramp to setpoint facility (PF 400 & PF 800)
- 28 to 910 litre chamber volumes
- Fan convection for rapid heating & recovery & excellent uniformity
- Chemically resistant stainless steel liner
- Two nickel-chrome plated wire shelves (The PF 400 is supplied with 3 wire shelves, the PF 800 with 3 perforated stainless steel shelves)
- Lever latch door & airtight silicone seal
- Compliant with safety standard BS EN 61010-2-010:2003

Heavy duty options

Model	Reinforced base	Heavy duty shelves	
	Max. weight [kg]	Max. quantity	Max. weight / shelf [kg]
PF 30	40	2	20
PF 60	60	3	20
PF 120	80	3	25
PF 200	100	4	25
PF 400	150	5	25
PF 800	225	5	75

Please note: Reinforced base, shelf runners and shelves supplied as a package

Technical data

Model	Max. temp. [°C]	Temp. stability [°C]	Temp. uniformity [°C]	Heat-up time [mins]	Recovery time [mins]	Dimensions: Internal H x W x D [mm]	Dimensions: External H x W x D [mm]	Shelves fitted / accepted	Shelf loading each / total [kg]	Volume [litres]	Air changes / hr	Max. power [W]	Holding power [W]	Weight [kg]
PF 30	300	±0.2	±5.0 @ 300°C	40	4	300 x 290 x 320	470 x 665 x 470 (Bench-top)	2 / 3	10 / 20	28	50 / 312*	1000	560	37
PF 60	300	±0.2	±5.0 @ 300°C	36	4	400 x 390 x 420	570 x 765 x 570 (Bench-top)	2 / 5	10 / 30	66	21 / 137*	1500	775	55
PF 120	300	±0.2	±5.0 @ 300°C	35	4	500 x 490 x 520	670 x 865 x 670 (Bench-top)	2 / 9	10 / 40	127	11 / 72*	2000	900	74
PF 200	300	±0.2	±5.0 @ 300°C	42	5	750 x 590 x 520	920 x 965 x 670 (Bench-top)	2 / 15	10 / 50	230	6 / 40*	2700	1180	96
PF 400	250	±0.2	±5.0 @ 250°C	85	25	1500 x 605 x 510	1835 x 1025 x 1100 (Floor-standing)	3 / 14	10 / 75	460	66*	6000	2200	200
PF 800	250	±0.2	±5.0 @ 250°C	100	30	1500 x 1200 x 510	1835 x 1615 x 1100 (Floor-standing)	3 / 7	10 / 100	910	33*	9000	3500	280

i Please note:

- Minimum operating temperature approximately ambient plus 30°C
- Uniformity is measured in an empty chamber with vents closed, after a stabilisation period
- Maximum power and heat up time based on a 240 V supply
- Stoving and curing option may require increased maximum power

- External dimensions with door closed
- The uniform volume is smaller than the total chamber volume
- Shelf loadings are based on evenly distributed weight

* When equipped with optional exhaust fan



PF120 oven with CC-T1 controller

Options (specify these at time of order)

- A range of sophisticated digital controllers, multisegment programmers and data loggers with digital communication options is available (see page 100)
- Over-temperature protection (recommended to protect valuable contents & for unattended operation)
- Access port for independent thermocouple
- Cable entry port
- Variable speed fan control
- Stoving & curing for extraction of small volumes of volatile solvents (not compatible with viewing window option)
- Viewing window (not compatible with stoving & curing option)
- Interior light (not compatible with stoving & curing option)
- Air exhaust fan
- Moisture extraction option (comprising sealed seams and air exhaust fan)
- Lockable door
- Door interlock activated by temperature alarm relay or program segment output (EPC3016, CC-T1, EPC3008 or nanodac)
- Door switch to isolate elements and fan



LHT – High Temperature Bench Mounted Ovens

The LHT laboratory high temperature ovens comprise three sizes of bench mounted ovens, each available with maximum operating temperatures of 400°C, 500°C and 600°C.

Standard features

- 400°C, 500°C or 600°C operating temperatures
- R38 PID controller (see below for other controller options)
- 30, 60 & 120 litre capacities
- Heavy duty convection fan for good uniformity
- Low thermal mass insulation for fast response & energy efficiency
- Corrosion resistant, brushed stainless steel interior
- 2 Multi-position shelves
- Suitable for continuous operation
- Hard wearing, zinc coated & stoved epoxy polyester coated exterior



LHT 6/60 with CC-T1 controller

Options (specify these at time of order)

- A range of sophisticated digital controllers, multisegment programmers and data loggers with digital communication options is available (see page 100)
- Over-temperature protection (recommended to protect valuable contents & for unattended operation)
- Viewing window
- Cable entry port
- Variable speed fan
- Floor stands & stacking frame with vent
- Routine spares kit
- Air exhaust fan (may alter achievable uniformity)
- Door interlock activated by temperature alarm relay or program segment output (EPC3016, CC-T1, EPC3008 or nanodac)

Heavy duty options

Model	Reinforced base	Heavy duty shelves	
	Max. weight [kg]	Max. quantity	Max. weight / shelf [kg]
LHT 30	40	2	20
LHT 60	60	3	20
LHT 120	80	3	25

Please note: Reinforced base, shelf runners and shelves supplied as a package

Technical data

CGH	Max. temp. [°C]	Temp. stability [°C]	Temperature uniformity [°C]	Heat-up time [mins]	Recovery time [mins]	Dimensions: Internal H x W x D [mm]	Dimensions: External H x W x D [mm]	Shelves fitted / accepted	Shelf loading each / total [kg]	Volume [litres]	Max. power [W]	Weight [kg]
LHT 4/30	400	±0.5	±5.0 @ 250°C	50	10	300 x 300 x 305	570 x 860 x 550	2	10 / 20	30	1000	73
LHT 4/60	400	±0.5	±5.0 @ 250°C	-	16	400 x 400 x 405	670 x 930 x 670	2 / 3	15 / 30	60	1500	99
LHT 4/120	400	±0.5	±5.0 @ 250°C	-	20	645 x 455 x 405	920 x 1060 x 670	2 / 4	15 / 40	120	2250	137
LHT 5/30	500	±0.5	±5.0 @ 250°C	-	10	300 x 300 x 305	570 x 860 x 550	2	10 / 20	30	2000	73
LHT 5/60	500	±0.5	±5.0 @ 250°C	50	16	400 x 400 x 405	670 x 930 x 670	2 / 3	15 / 30	60	2250	99
LHT 5/120	500	±0.5	±5.0 @ 250°C	-	20	645 x 455 x 405	920 x 1060 x 670	2 / 4	15 / 40	120	3000	137
LHT 6/30	600	±0.5	±5.0 @ 250°C	70	10	300 x 300 x 305	570 x 860 x 550	2	10 / 20	30	2000	73
LHT 6/60	600	±0.5	±5.0 @ 250°C	-	10*	400 x 400 x 405	670 x 930 x 670	2 / 3	15 / 30	60	2250	99
LHT 6/120	600	±0.5	±5.0 @ 250°C	-	-	645 x 455 x 405	920 x 1060 x 670	2 / 4	15 / 40	120	3000	137

ⓘ Please note:

- Minimum operating temperature approximately ambient plus 60°C
- *Recovery to 500°C setpoint

- External dimensions with door closed
- The uniform volume is smaller than the total chamber volume
- Maximum power and heat up time based on a 240 V supply



GP – General Purpose Ovens

The GP general purpose 300°C industrial ovens are supplied in three sizes and two configurations: vertical (A) and horizontal (B) airflow.

This range also provides a foundation upon which a wide range of custom modifications can be added. Typical examples of which are the more sophisticated control systems and data recording that is required for applications such as AMS2750F heat treatment under Nadcap, or modifications to handle heavier loads or assist in loading and unloading the oven, or simply larger chamber sizes than are offered in the standard range.

Standard features

- 300°C maximum operating temperature
- Carbolite Gero 301 controller with single ramp to setpoint facility
- 430 grade ferritic stainless steel internal case
- Robust external construction from steel section & zinc coated mild steel panels
- Mineral insulated metal sheathed heating elements
- Adjustable chamber ventilation

Heavy duty options

Model	Reinforced base	Heavy duty shelves	
	Max. weight [kg]	Max. quantity	Max. weight / shelf [kg]
GP 220A	150	3	50
GP 330A	200	4	50
GP 450A	250	5	50
GP 220B	150	3	50
GP 330B	225	3	75
GP 450B	225	3	75

Please note: Reinforced base, shelf runners and shelves supplied as a package



GP 450A with EPC3016P1 programmer option and over-temperature protection, plus AMS2750F thermocouple connection loops

GP 330B with EPC3008P10 programmer and exhaust fan option

Options (specify these at time of order)

- A range of sophisticated digital controllers, multisegment programmers and data loggers with digital communication options is available (see page 100)
- Over-temperature protection (recommended to protect valuable contents & for unattended operation)
- Port for independent thermocouple
- Cable access ports
- Bespoke models are available for AMS2750F (Nadcap) compliant applications
- Additional shelves
- Door interlock activated by temperature alarm relay or program segment output (EPC3016, CC-T1, EPC3008 or nanodac)
- Stoving & curing for extraction of small volumes of volatile solvents (not compatible with viewing window option)
- Viewing window (not compatible with stoving & curing option)
- Interior light (not compatible with stoving & curing option)
- Air exhaust fan
- Moisture extraction option (comprising sealed seams and air exhaust fan)

Technical data

Model	Max. temp. [°C]	Temp. stability [°C]	Temp. uniformity [°C]	Heat-up time [mins]	Recovery time [mins]	Dimensions: Internal H x W x D [mm]	Dimensions: External H x W x D [mm]	Shelves fitted / accepted	Shelf loading each / total [kg]	Doors	Volume [litres]	Air changes / hr	Max. power [W]
GP 220A	300	±0.5	±5.0	75	24	610 x 610 x 610	1240 x 862 x 850 (Bench-top)	3 / 5	15 / 45	Single door	220	107*	3000
GP 330A	300	±0.5	±5.0	80	28	915 x 610 x 610	1545 x 862 x 850 (Floor-standing or optional stand)	4 / 8	15 / 60	Single door	330	76*	4500
GP 450A	300	±0.5	±5.0	75	30	1220 x 610 x 610	1850 x 862 x 850 (Floor-standing)	5 / 11	15 / 75	Single door	450	59*	6000
GP 220B	300	±0.5	±5.0	75	24	610 x 610 x 610	910 x 1190 x 850 (Bench-top)	3 / 5	15 / 45	Single door	220	107*	3000
GP 330B	300	±0.5	±5.0	80	30	610 x 915 x 610	910 x 1495 x 850 (Bench-top)	3 / 5	15 / 45	Double Door	330	76*	4500
GP 450B	300	±0.5	±5.0	75	35	610 x 1220 x 610	910 x 1800 x 850 (Bench-top)	3 / 5	20 / 60	Double Door	450	59*	6000

i Please note:

- Minimum operating temperature approximately ambient plus 30°C
- Uniformity is measured in an empty chamber with vents closed, after a stabilisation period
- Maximum power and heat up time based on a 240 V supply
- Stoving and curing option may require increased maximum power
- Shelf loadings are based on evenly distributed weight
- External dimensions with door closed
- The uniform volume is smaller than the total chamber volume
- * When equipped with optional exhaust fan



TLD – Rapid Cooling Ovens

These ovens are frequently used for annealing thermo-luminescent dosimeters (TLD) that have been used to measure exposure to ionising radiation.

The TLD ovens are designed to heat to 400°C, cooling rapidly to ambient temperature using forced air cooling. This rapid cycling capability is also suitable for other small scale tempering and annealing applications.



TLD/3 with over-temperature option

Standard features

- 400 °C maximum operating temperature
- CC-T1 programmable controller providing automatic activation of the cooling blower
- Horizontal forced air circulation from rear mounted fan
- Excellent performance & reliability
- Stainless steel liner
- Stainless steel mesh shelves

Options (specify these at time of order)

- A range of sophisticated digital controllers, multisegment programmers and data loggers with digital communication options is available (see page 100)
- Independent over-temperature protection with digital setpoint & display

Technical data

CGH	Max. temp. [°C]	Temp. stability [°C]	Temperature uniformity [°C]	Heat-up time [mins]	Heating/cooling rate [°C/mins]	Dimensions: Internal H x W x D [mm]	Dimensions: External H x W x D [mm]	Shelves fitted / accepted	Shelf loading each / total [kg]	Volume [litres]	Max. power [W]	Weight [kg]
TLD/3	400	±1	±5.0	60	4*	150 x 150 x 100	530 x 370 x 500	2 / 2	1 / 2	3	1000	26
TLD/28	400	±1	±5.0	60	4*	305 x 305 x 305	880 x 675 x 865	2 / 2	10 / 20	28	2250	95

i Please note:

- Minimum operating temperature approximately ambient plus 50°C
- Uniformity is measured in an empty chamber with vents closed, after a stabilisation period
- Maximum power and heat up time based on a 240 V supply

- External dimensions with door closed
- The uniform volume is smaller than the total chamber volume
- * Based upon cooling an empty chamber



HT – High Temperature Industrial Ovens

The HT high temperature ovens are manufactured in four standard chamber sizes with maximum operating temperatures of 400°C, 500°C, 600°C and 700°C. Their robust construction incorporates heavy duty hinges, door catches and shelving systems.

This range also provides a foundation upon which a wide range of custom modifications can be added. Typical examples are the more sophisticated control systems and data recording that is required for applications such as AMS2750F heat treatment under Nadcap, or modifications to handle heavier loads or assist in loading and unloading the oven, or simply larger chamber sizes than are offered in the standard range.

Standard features

- 400°C, 500°C, 600°C or 700°C operating temperatures
- Carbolite Gero 301 controller providing single ramp to set point
- 28, 95, 220 or 350 litre capacity
- Stainless steel liner and perforated shelves



HT 6/220 with EPC3016P1 programmer and over-temperature options

Options (specify these at time of order)

- A range of sophisticated digital controllers, multisegment programmers and data loggers with digital communication options is available (see page 100)
- Over-temperature protection (recommended to protect valuable contents & for unattended operation)
- Additional shelves
- Viewing window (not compatible with stoving and curing option)
- Stoving & curing options for extraction of small volumes of volatile solvents (not compatible with viewing window option or gas inlet option)
- Door interlock activated by temperature alarm relay or program segment output (EPC3016, CC-T1, EPC3008 or nanodac)

Heavy duty options

Model	Reinforced base	Heavy duty shelves	
	Max. weight [kg]	Max. quantity	Max. weight / shelf [kg]
HT 28	40	2	20
HT 95	100	3	25
HT 220	150	4	50
HT 350	250	4	60

Please note: Reinforced base, shelf runners and shelves supplied as a package

Technical data

CGH Model	Max. temp. [°C]	Temp. stability [°C]	Temperature uniformity [°C]	Heat-up time [mins]	Recovery time [mins]	Dimensions: Internal H x W x D [mm]	Dimensions: External H x W x D [mm]	Shelves fitted / accepted	Shelf loading each / total [kg]	Volume [litres]	Max. power [W]
HT 4/28	400	±0.5	±5.0	60	10	305 x 305 x 305	880 x 685 x 885	2 / 2	10 / 20	28	1000
HT 4/95	400	±0.5	±5.0	60	10	455 x 455 x 455	1010 x 880 x 1120	3 / 4	15 / 30	94	3000
HT 4/220	400	±0.5	±5.0	60	10	610 x 610 x 610	1160 x 1030 x 1280	3 / 4	25 / 50	227	4000
HT 4/350	400	±0.5	±5.0	60	10	700 x 700 x 700	1775 x 1750 x 1200	3 / 3	25 / 50	343	6000
HT 5/28	500	±0.5	±5.0	60	16	305 x 305 x 305	880 x 685 x 885	2 / 2	10 / 20	28	2000
HT 5/95	500	±0.5	±5.0	60	16	455 x 455 x 455	1010 x 880 x 1120	3 / 4	15 / 30	94	4500
HT 5/220	500	±0.5	±5.0	60	16	610 x 610 x 610	1160 x 1030 x 1280	3 / 4	25 / 50	227	6000
HT 5/350	500	±0.5	±5.0	60	16	700 x 700 x 700	1775 x 1750 x 1200	3 / 3	25 / 50	343	7500
HT 6/28	600	±0.5	±5.0	75	20	305 x 305 x 305	880 x 685 x 885	2 / 2	10 / 20	28	2000
HT 6/95	600	±0.5	±5.0	70	20	455 x 455 x 455	1010 x 880 x 1120	3 / 4	15 / 30	94	4500
HT 6/220	600	±0.5	±5.0	90	20	610 x 610 x 610	1160 x 1030 x 1280	3 / 4	25 / 50	227	9000
HT 6/350	600	±0.5	±5.0	90	20	700 x 700 x 700	1775 x 1750 x 1200	3 / 3	25 / 50	343	12000
HT 7/28	700	±0.5	±5.0	90	24	305 x 305 x 305	905 x 735 x 885	2 / 2	8 / 16	28	3000
HT 7/95	700	±0.5	±5.0	95	24	455 x 455 x 455	1035 x 930 x 1120	3 / 4	10 / 30	94	6000
HT 7/220	700	±0.5	±5.0	120	24	610 x 610 x 610	1185 x 1080 x 1280	3 / 4	15 / 45	227	10000

i Please note:

- Minimum operating temperature approximately ambient plus 60°C
- Uniformity is measured in an empty chamber with vents closed, after a stabilisation period
- Maximum power and heat up time based on a 240 V supply

- Stoving and curing option increases the maximum power by 1500 W
- Shelf loadings are based on evenly distributed weight
- External dimensions with door closed
- The uniform volume is smaller than the total chamber volume



LGP – Large General Purpose Ovens

The LGP large general purpose ovens offer the greatest choice of options in size and maximum temperature. The range spans from 500 to more than 13000 litres, with a temperature span from 250°C to 700°C.

The LGP range is often customised in order to precisely meet the user's requirements.

Typical examples of which are the more sophisticated control systems and data recording that is required for applications such as AMS2750F heat treatment under Nadcap, or modifications to handle heavier loads or assist in loading and unloading the oven, or simply larger chamber sizes than are offered in the standard range.



LGP 2/3370 with exhaust fan option

Standard features

- 250°C, 425°C, 625°C or 700°C maximum operating temperatures
- PID digital set and display using the EPC3016P1 controller
- 500 to 13820 litre chamber volumes
- Large capacity, rugged well proven designs
- Robust construction, for heavy duty cycles
- Efficient air circulation and excellent temperature uniformity from heavy duty impellers
- Corrosion resistant ferritic grade 430 stainless steel interior
- Steel section & zinc coated, painted mild steel exterior
- Single & double door models
- Shelf runners on models up to 1000 litres (optional on models up to 5830 litres)
- Low thermal mass insulation for fast response & energy efficiency
- Fully adjustable chamber ventilation
- Over-temperature protection (recommended to protect valuable contents & for unattended operation)
- LGP 4/ and LGP 6/ models include independent element over-temperature protection
- **NEW** Ethernet communications



LGP 4/1000 with exhaust fan option

Options (specify these at time of order)

- A range of sophisticated digital controllers, multisegment programmers and data loggers with digital communication options is available (see page 100)
- Bespoke models are available for AMS2750F (Nadcap) compliant applications
- Access ports for cables & pipes
- Exhaust proving switch
- Manual or motorised vertically opening doors
- Vertical airflow impellers
- Explosion relief panels
- Interior light (subject to temperature limitations)
- Standard or heavy duty shelves
- A wide range of sample loading & handling accessories can also be supplied



Shelf Runners and Shelves Information

Models 500, 730 and 1000 litres: supplied with 4 pairs of shelf runners as standard. Shelves are available at extra cost.

For the following models the shelf runners and shelves are available at additional cost:

Models 1500, 2160 and 3370 litres: available with 7 pairs of shelf runners.

Model 1750 litres: available with 5 pairs of shelf runners.

Model 5830 litres: available with 9 pairs of shelf runners.

Larger capacity models are not supplied with any shelf runners.

Technical data

CGH	Max. temp. [°C]	Temp. stability [°C]	Temperature uniformity [°C]	Heat-up time [mins]	Dimensions: Internal H x W x D [mm]	Dimensions: External H x W x D [mm]	Doors	Shelf loading each / total [kg]	Volume [litres]	Max. power [W]
LGP 2/500	250	±0.5	±5.0 @250°C	60	800 x 800 x 800	1300 x 1710 x 1350	Single door	50 / 200	500	9000
LGP 2/730	250	±0.5	±5.0 @250°C	60	900 x 900 x 900	1400 x 1810 x 1450	Single door	50 / 200	730	9000
LGP 2/1000	250	±0.5	±5.0 @250°C	60	1000 x 1000 x 1000	1500 x 1910 x 1550	Single door	50 / 200	1000	12000
LGP 2/1500	250	±0.5	±5.0 @250°C	60	1500 x 1000 x 1000	2000 x 1910 x 1550	Single door	50 / 350	1500	13500
LGP 2/1750	250	±0.5	±5.0 @250°C	60	1200 x 1200 x 1200	1700 x 2110 x 1750	Single door	50 / 250	1750	18000
LGP 2/2160	250	±0.5	±5.0 @250°C	60	1500 x 1200 x 1200	2000 x 2110 x 1750	Single door	50 / 350	2160	18000
LGP 2/3370	250	±0.5	±5.0 @250°C	60	1500 x 1500 x 1500	2000 x 3010 x 2050	Double door	50 / 350	3370	24000
LGP 2/5830	250	±0.5	±5.0 @250°C	60	1800 x 1800 x 1800	2300 x 3310 x 2350	Double door	50 / 450	5830	35000
LGP 2/8000	250	±0.5	±5.0 @250°C	60	2000 x 2000 x 2000	2500 x 3510 x 2550	Double door	-	8000	42000
LGP 2/13820	250	±0.5	±5.0 @250°C	60	2400 x 2400 x 2400	2900 x 3910 x 2950	Double door	-	13820	60000
LGP 4/500	425	±0.5	±5.0 @250°C	60	800 x 800 x 800	1450 x 1820 x 1520	Single door	50 / 200	500	9000
LGP 4/730	425	±0.5	±5.0 @250°C	60	900 x 900 x 900	1550 x 1920 x 1620	Single door	50 / 200	730	12000
LGP 4/1000	425	±0.5	±5.0 @250°C	60	1000 x 1000 x 1000	1650 x 2020 x 1720	Single door	50 / 200	1000	18000
LGP 4/1500	425	±0.5	±5.0 @250°C	60	1500 x 1000 x 1000	2150 x 2620 x 1720	Single door	50 / 350	1500	21000
LGP 4/1750	425	±0.5	±5.0 @250°C	60	1200 x 1200 x 1200	1850 x 2820 x 1920	Single door	50 / 250	1750	24000
LGP 4/2160	425	±0.5	±5.0 @250°C	60	1500 x 1200 x 1200	2150 x 2820 x 1920	Single door	50 / 350	2160	27000
LGP 4/3370	425	±0.5	±5.0 @250°C	60	1500 x 1500 x 1500	2150 x 3120 x 2220	Double door	50 / 350	3370	36000
LGP 4/5830	425	±0.5	±5.0 @250°C	60	1800 x 1800 x 1800	2450 x 3420 x 2520	Double door	50 / 350	5830	48000
LGP 4/8000	425	±0.5	±5.0 @250°C	60	2000 x 2000 x 2000	2650 x 3620 x 2720	Double door	50 / 450	8000	54000
LGP 6/500	625	±0.5	±5.0 @250°C	75	800 x 800 x 800	1450 x 1820 x 1520	Single door	50 / 200	500	13500
LGP 6/730	625	±0.5	±5.0 @250°C	75	900 x 900 x 900	1550 x 1920 x 1620	Single door	50 / 200	730	18000
LGP 6/1000	625	±0.5	±5.0 @250°C	75	1000 x 1000 x 1000	1650 x 2020 x 1720	Single door	50 / 200	1000	24000
LGP 6/1500	625	±0.5	±5.0 @250°C	75	1500 x 1000 x 1000	2150 x 2620 x 1720	Single door	50 / 350	1500	30000
LGP 6/1750	625	±0.5	±5.0 @250°C	75	1200 x 1200 x 1200	1850 x 2820 x 1920	Single door	50 / 250	1750	36000
LGP6/2160	625	±0.5	±5.0 @250°C	75	1500 x 1200 x 1200	2150 x 2820 x 1920	Single door	50 / 350	2160	40000
LGP 6/3370	625	±0.5	±5.0 @250°C	75	1500 x 1500 x 1500	2150 x 3120 x 2220	Double door	50 / 350	3370	48000
LGP 6/5830	625	±0.5	±5.0 @250°C	75	1800 x 1800 x 1800	2450 x 3420 x 2520	Double door	50 / 450	5830	72000
LGP 7/500	700	±0.5	±5.0 @250°C	-	800 x 800 x 800	1450 x 1820 x 1520	Single door	50 / 200	500	18000
LGP 7/730	700	±0.5	±5.0 @250°C	-	900 x 900 x 900	1550 x 1920 x 1620	Single door	50 / 200	730	21000
LGP 7/1000	700	±0.5	±5.0 @250°C	-	1000 x 1000 x 1000	1650 x 2020 x 1720	Single door	50 / 200	1000	27000
LGP 7/1500	700	±0.5	±5.0 @250°C	-	1500 x 1000 x 1000	2150 x 2620 x 1720	Single door	50 / 350	1500	33000

i Please note:

- Minimum operating temperature approximately ambient plus 35°C
- Uniformity is measured in an empty chamber with vents closed, after a stabilisation period
- Maximum power and heat up time based on a 240 V supply

- Shelf loadings are based on evenly distributed weight
- External dimensions with door closed
- The uniform volume is smaller than the total chamber volume



HTMA – High Temperature Modified Atmosphere Ovens

The HTMA range of modified atmosphere high temperature ovens is for use with inert atmospheres.

Separate flow controls for purge and process gases mean that once the chamber has been purged of atmospheric air process gas can be used with lower flow rates. Switching between purge and process gases can either be done manually or by adding the option of an automatic programmable control system. Oxygen levels down to **50 ppm** are achievable.



HTMA 6/28 with EPC3008P10 programmer and automatic gas control options

Standard features

- 400 °C, 500 °C, 600 °C or 700 °C maximum operating temperatures
- Carbolite Gero 301 PID controller with single ramp to setpoint and including over-temperature protection
- 28, 95, 220, 500 & 1000 litre capacities
- Rear mounted fan & side air guides give horizontal 'airflow'
- Fully seam welded to contain modified atmosphere
- Manual gas control via needle valves & flowmeters (nickel brass)
- Corrosion resistant stainless steel interior with perforated shelves & runners
- Stainless steel pipe-work, nickel brass flow-meter & solenoid valves
- Single side hinged door, with metal heat seal & rubber gas tight seal, closed using non slam handle
- Gas inlet connection: bulkhead compression fitting to suit 10 mm outside diameter tube (maximum inlet pressure = 2 bar)

Options (specify these at time of order)

- A range of sophisticated digital controllers, multisegment programmers and data loggers with digital communication options is available (see page 100)
- Automatic gas control (requires a EPC3016P1, CC-T1, EPC3008P10 or Nanodac series programmable controller)
- Stainless steel flow-meter & solenoid valves, instead of nickel brass
- Fixed or castor mounted floor stands
- Oxygen sensor fitted to gas outlet to monitor oxygen level, displayed as percentage. Only available for use with nanodac™ instruments.
- Door interlock activated by temperature alarm relay or program segment output (EPC3016, CC-T1, EPC3008 or nanodac)

Technical data

CGH	Max. temp. [°C]	Heat-up time [mins]	Recovery time [mins]	Dimensions: Internal H x W x D [mm]	Dimensions: External H x W x D [mm]	Shelves fitted / accepted	Shelf loading each / total [kg]	Volume [litres]	Max. power [W]	Weight [kg]
HTMA 4/28	400	60	10	305 x 305 x 305	990 x 810 x 885	2 / 2	10 / 20	28	1000	73
HTMA 4/95	400	75	16	455 x 455 x 455	1120 x 1015 x 1120	3 / 4	15 / 30	94	3000	99
HTMA 4/220	400	120	20	610 x 610 x 610	1270 x 1165 x 1280	3 / 4	25 / 50	227	4000	179
HTMA 4/500	400	-	-	800 x 800 x 800	1305 x 1115 x 1450	3 / 5	- / -	500	7500	-
HTMA 4/1000	400	-	-	1000 x 1000 x 1000	1310 x 1530 x 1635	3 / 5	- / -	1000	12000	-
HTMA 5/28	500	60	10	305 x 305 x 305	990 x 810 x 885	2 / 2	10 / 20	28	2000	73
HTMA 5/95	500	75	16	455 x 455 x 455	1120 x 1015 x 1120	3 / 4	15 / 30	94	4500	99
HTMA 5/220	500	120	20	610 x 610 x 610	1270 x 1165 x 1280	3 / 4	25 / 50	227	6000	179
HTMA 5/500	500	-	-	800 x 800 x 800	1305 x 1115 x 1450	3 / 5	- / -	500	9000	-
HTMA 5/1000	500	-	-	1000 x 1000 x 1000	1310 x 1530 x 1635	3 / 5	- / -	1000	15000	-
HTMA 6/28	600	60*	10*	305 x 305 x 305	990 x 810 x 885	2 / 2	10 / 20	28	2000	73
HTMA 6/95	600	75*	16*	455 x 455 x 455	1120 x 1015 x 1120	3 / 4	15 / 30	94	4500	99
HTMA 6/220	600	120*	20*	610 x 610 x 610	1270 x 1165 x 1280	3 / 4	25 / 50	227	9000	179
HTMA 6/500	600	-	-	800 x 800 x 800	1305 x 1115 x 1450	3 / 5	- / -	500	12000	-
HTMA 6/1000	600	-	-	1000 x 1000 x 1000	1310 x 1530 x 1635	3 / 5	- / -	1000	15000	-
HTMA 7/28	700	90	24	305 x 305 x 305	1085 x 860 x 890	2 / 2	8 / 16	28	3000	85
HTMA 7/95	700	95	24	455 x 455 x 455	1145 x 1065 x 1120	3 / 4	10 / 30	94	6000	115
HTMA 7/220	700	120	24	610 x 610 x 610	1295 x 1215 x 1280	3 / 4	15 / 45	227	10000	195

Please note:

- Minimum operating temperature approximately ambient plus 60°C
- Uniformity is measured in an empty chamber with vents closed, after a stabilisation period

- Maximum power and heat up time based on a 240 V supply
- External dimensions with door closed

* Nominal values based upon a representative sample of products



CR – Clean Room Ovens

The CR range of 250°C clean room ovens comprises nine standard models in sizes from the 30 litre model to the 1790 litre model which, once processed through a customer’s standard material entry regime, are suitable for operation within an **ISO 14644-1 Class 5** environment*. All sources of particulate contamination are fully sealed. Their easily cleaned stainless steel interiors and gloss white epoxy exteriors prevent the shedding of particulate contamination.

*Federal Standard 209E Class 100 was superseded in 2001 by ISO 14644-1 Class 5



CR 70 & CR 30

Standard features

- 250°C maximum operating temperature
- Carbolite Gero 301 controller with single ramp to setpoint
- 30 to 1790 litre chamber volumes
- Fully sealed low thermal mass insulation to avoid shedding fibres
- Fully enclosed brushless fan motor
- Perforated stainless steel shelves
- Particle free silicone rubber door seal
- Membrane control panel with clear bright LED display

Options (specify these at time of order)

- A range of sophisticated digital controllers, multisegment programmers and data loggers with digital communication options is available (see page 100)
- Over-temperature protection (recommended to protect valuable contents & for unattended operation)
- Access port for independent thermocouple
- Cable access port
- Viewing window
- Frame to enable units to be stacked one upon another
- Lockable door
- Door switch to isolate elements and fan
- Fully customised through wall (flange fitted) designs are available
- Door interlock activated by temperature alarm relay or program segment output (EPC3016, CC-T1, EPC3008 or nanodac)
- **NEW** Inert atmosphere option

Technical data

CGH Model	Max. temp. [°C]	Temp. stability [°C]	Temperature uniformity [°C]	Heat-up time [mins]	Recovery time [mins]	Dimensions: Internal H x W x D [mm]	Dimensions: External H x W x D [mm]	Shelves fitted / accepted	Shelf loading each / total [kg]	Volume [litres]	Max. power [W]
CR/30	250	±0.2	±3.0 @ 250°C	35	4	310 x 310 x 310	685 x 460 x 670 (Bench-top or optional stand)	2 / 2	10 / 20	30	1000
CR/70	250	±0.2	±3.0 @ 250°C	35	4	310 x 470 x 470	685 x 620 x 820 (Bench-top or optional stand)	2 / 2	10 / 20	68	1500
CR/130	250	±0.2	±4.0 @ 250°C	35	4	550 x 470 x 470	925 x 620 x 820 (Bench-top or optional stand)	3 / 5	10 / 40	121	2000
CR/180	250	±0.2	±5.0 @ 250°C	58	5	770 x 470 x 470	1145 x 620 x 820 (Bench-top or optional stand)	3 / 7	10 / 50	170	2500
CR/220	250	±0.2	±5.0 @ 250°C	75	4	610 x 610 x 610	1360 x 940 x 970 (Bench-top or optional stand)	3 / 5	15 / 45	227	3000
CR/330	250	±0.2	±5.0 @ 250°C	80	6	915 x 610 x 610	1670 x 940 x 970 (Floor-standing or optional stand)	4 / 8	15 / 60	340	4500
CR/450	250	±0.3	±5.0 @ 250°C	75	9	1220 x 610 x 610	1930 x 940 x 970 (Floor-standing or optional stand)	5 / 11	15 / 75	450	6000
CR/840	250	±0.3	±5.0 @ 250°C	-	-	1525 x 915 x 610	2235 x 1395 x 970 (Floor-standing)	6	15 / -	850	12000
CR/1790	250	±0.3	±5.0 @ 250°C	-	-	1220 x 1220 x 1220	1930 x 1750 x 1580 (Floor-standing)	5	15 / -	1810	18000

i Please note:

- Minimum operating temperature approximately ambient plus 30°C
- Uniformity is measured in an empty chamber with vents closed, after a stabilisation period
- Maximum power and heat up time based on a 240 V supply

- Shelf loadings are based on evenly distributed weight
- External dimensions with door closed
- The uniform volume is smaller than the total chamber volume



HTCR – High Temperature Clean Room Ovens



HTCR 4/95

HTCR 6/28
with EPC3016P1 programmer option

The HTCR range of clean room ovens comprises **15 standard models with five sizes between 28 and 1000 litres available with maximum temperatures of 400 °C, 500 °C and 600 °C.**

Once processed through a customer's standard material entry regime HTCR Ovens are suitable for operation within an **ISO 14644-1 Class 6** environment. Federal Standard 209E Class 1000 was superseded in 2001 by ISO 14644-1 Class 6.

Optionally HTCR ovens can be supplied for operation within an **ISO 14644-1 Class 5** environment: Federal Standard 209E Class 100 was superseded in 2001 by ISO 14644-1 Class 5.

Airflow in HTCR

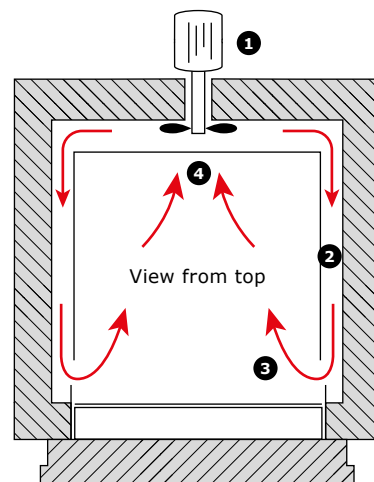

- 1) Air circulation fan
- 2) Heating elements heat the air
- 3) Heated air enters the chamber
- 4) Air from the chamber moves into the circulation fan

Airflow path as viewed from above

Standard features

- 400 °C, 500 °C or 600 °C maximum operating temperatures
- Carbolite Gero 301 PID controller with single ramp to setpoint and including over-temperature protection
- 28 to 1000 litre chamber volumes
- Fully sealed low thermal mass insulation avoids shedding fibres
- Fully enclosed brushless fan motor
- Smooth easily cleaned gloss epoxy exterior
- Polished stainless steel sealed interior
- Perforated stainless steel shelves
- Particle free silicone rubber door seal
- Membrane control panel with clear bright LED display
- Double skin construction for cool safe outer case temperature
- Door switch



HTCR – High Temperature Clean Room Ovens

Options (specify these at time of order)

- A range of sophisticated digital controllers, multisegment programmers and data loggers with digital communication options is available (see page 100)
- ISO-14644-1 Class 5 models are optionally available
- Access port for independent thermocouple
- Cable access port
- Lockable door
- Fixed or castor mounted floor stands
- Through wall (flange fitted) as well as fully bespoke designs are available
- Door interlock activated by temperature alarm relay or program segment output (EPC3016, CC-T1, EPC3008 or nanodac)

Clean room classifications

Standard	Classification			
	5	6	7	8
ISO 14644-1	5	6	7	8
BS 5295	E/F	G/H	J	K
Federal standard 209E	100	1000	10000	100000

Technical data

CGH Model	Max. temp. [°C]	Temp. stability [°C]	Temp. uniformity [°C]	Heat-up time [mins]	Recovery time [mins]	Dimensions: Internal H x W x D [mm]	Dimensions: External H x W x D [mm]	Shelves fitted / accepted	Shelf loading each / total [kg]	Volume [litres]	Max. power [W]
HTCR 4/28	400	±0.5	±5.0 @ 250°C	60	10	305 x 305 x 305	880 x 675 x 885 (Bench-top or optional stand)	2 / 2	10 / 20	28	1000
HTCR 4/95	400	±0.5	±5.0 @ 250°C	90	10	455 x 455 x 455	1010 x 810 x 1120 (Bench-top or optional stand)	3 / 4	15 / 30	94	3000
HTCR 4/220	400	±0.5	±5.0 @ 250°C	75	16	610 x 610 x 610	1160 x 1030 x 1280 (Bench-top or optional stand)	3 / 4	10 / 50	227	4000
HTCR 4/500	400	±0.5	±5.0 @ 250°C	-	-	800 x 800 x 800	1305 x 1115 x 1450 (Floor-standing or optional stand)	3 / 5	-	510	7500
HTCR 4/1000	400	±0.5	±5.0 @ 250°C	-	-	1000 x 1000 x 1000	1310 x 1530 x 1635 (Floor-standing or optional stand)	3 / 5	-	1000	12000
HTCR 5/28	500	±0.5	±5.0 @ 250°C	75	16	305 x 305 x 305	880 x 675 x 885 (Bench-top or optional stand)	2 / 2	10 / 20	28	2000
HTCR 5/95	500	±0.5	±5.0 @ 250°C	110	16	455 x 455 x 455	1010 x 810 x 1120 (Bench-top or optional stand)	3 / 4	15 / 30	94	4500
HTCR 5/220	500	±0.5	±5.0 @ 250°C	105	16	610 x 610 x 610	1160 x 1030 x 1280 (Bench-top or optional stand)	3 / 4	10 / 50	227	6000
HTCR 5/500	500	±0.5	±5.0 @ 250°C	-	-	800 x 800 x 800	1305 x 1155 x 1450 (Floor-standing or optional stand)	3 / 5	10 / 20	510	9000
HTCR 5/1000	500	±0.5	±5.0 @ 250°C	-	-	1000 x 1000 x 1000	1310 x 1530 x 1635 (Floor-standing or optional stand)	3 / 5	15 / 30	1000	15000
HTCR 6/28	600	±0.5	±5.0 @ 250°C	110	20	305 x 305 x 305	880 x 675 x 885 (Bench-top or optional stand)	2 / 2	10 / 50	28	2000
HTCR 6/95	600	±0.5	±5.0 @ 250°C	110	20	455 x 455 x 455	1010 x 810 x 1120 (Bench-top or optional stand)	3 / 4	10 / 20	94	4500
HTCR 6/220	600	±0.5	±5.0 @ 250°C	120	20	610 x 610 x 610	1160 x 1030 x 1280 (Bench-top or optional stand)	3 / 4	15 / 30	227	9000
HTCR 6/500	600	±0.5	±5.0 @ 250°C	-	-	800 x 800 x 800	1305 x 1155 x 1450 (Floor-standing or optional stand)	3 / 5	-	510	12000
HTCR 6/1000	600	±0.5	±5.0 @ 250°C	-	-	1000 x 1000 x 1000	1310 x 1530 x 1635 (Floor-standing or optional stand)	3 / 5	-	1000	15000

i Please note:

- Minimum operating temperature approximately ambient plus 60°C
- Uniformity is measured in an empty chamber with vents closed, after a stabilisation period
- Maximum power and heat up time based on a 240 V supply

- External dimensions with door closed
- The uniform volume is smaller than the total chamber volume

Laboratory & Industrial Chamber Furnaces up to 1800 °C



Chamber Furnaces	Models	Page
Chamber Furnaces Selection Guide		28
Laboratory Chamber Furnaces	ELF, CWF, CWF-B, CWF-BAL, HRF, RWF, VCF, RHF, BLF, HTF	29
Industrial Chamber Furnaces	HTF, GPC, GPCMA, GLO, HB, LCF, SBCF	40
Ashing Furnaces Selection Guide		52
Ashing Furnaces	AAF, AAF-BAL, GSM, ABF, ABA	53

Carbolite Gero's extensive chamber furnace range has a maximum operating temperature of 1800 °C and chamber capacities up to 725 litres. They are suitable for a variety of laboratory, pilot scale and industrial applications. Although there is flexibility in size and temperature, if the application requires the use of modified atmosphere (above 1100 °C) or vacuum then a furnace from Carbolite Gero's tube furnace range should be selected.

Carbolite Gero's design features optimised uniform volume

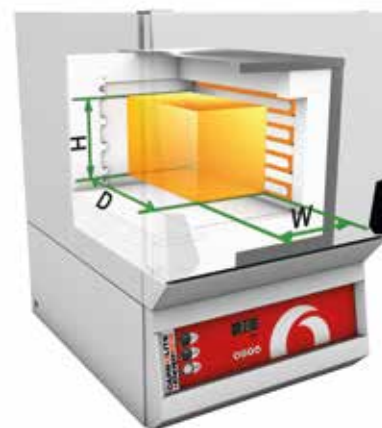

The selection of a chamber furnace should take into account the following factors:

General considerations

- Chamber furnaces have the advantage of being able to heat larger items than tube furnaces
- The size of the chamber required and how it is loaded/unloaded will determine which style of furnace is best for the application
- For applications involving chemical vapours, gases or humidity please check with Carbolite Gero or your local dealer which furnace meets the requirements

What temperature?

- Carbolite Gero considers all products above 700 °C which are heated using radiant heat, (rather than convection), as furnaces
- The range of chamber furnaces is available up to a maximum operating temperature of 1800 °C
- Continuous operation of a furnace at its maximum temperature will reduce its life. Recommended maximum continuous operating temperature is 100 °C below the maximum operating temperature
- Furnaces are designed to operate at high temperatures. Operation below temperatures of approximately 600 °C will be less accurate and continuous use at low temperatures may reduce the element life of some furnaces, ie MoSi₂ heated furnaces
- Each furnace has a uniform working volume; this is a three-dimensional space which meets a specific tolerance and is smaller than the total chamber volume. Carbolite Gero's designs optimise this uniform volume for applications that require a specific temperature uniformity (the image top right shows a typical optimised uniform volume H x W x D)

Chamber design

- The simplest and least expensive furnaces have front opening side or bottom-hinged doors
- Higher specification front opening 'up and away' vertically lifting doors keep the hot face insulation away from the operator, increasing safety and comfort
- Where tall objects and crucibles need lifting in and out of the chamber, vertically loading furnaces with heating elements in the chamber sides are available
- Bottom loading furnaces allow the load to be lifted into the heated chamber, or lowered to cool them

Modified atmosphere

To work with inert gases or modified atmosphere, one of the following options must be selected at order placement:

- A gasket, elastomer seal or sand sealed retort in a front opening chamber furnace
- An inverted crucible on a modified hearth in a bottom loading furnace (BLF 1600°C, 1700°C and 1800°C models)

Temperature control

- All furnaces are supplied with accurate PID (proportional, integral and derivative) single ramp to setpoint controllers providing accurate control and minimal temperature overshoot. Higher temperature furnaces feature an 24-segment programmer as standard
- Multi-segment and/or multi-program controllers are available as an option on most models, please see page 100
- Over-temperature protection is strongly recommended when a furnace is operating whilst unattended, or where the sample is valuable

Application specific and custom built furnaces

Carbolite Gero designs and manufactures all the furnaces within its range. Many options are available, as well as fully customised furnaces for specific applications. For examples of custom built furnaces and ovens please see page 95 or separate catalogue 'Custom Designed Ovens & Furnaces up to 1800°C'

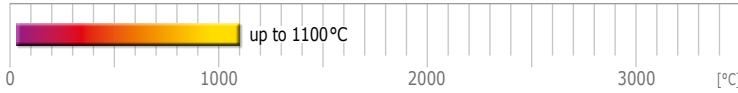

ELF – Economy Chamber Furnaces

The ELF laboratory furnaces comprise three bench mounted models designed for light duty and general use up to 1100 °C.

They have a simple drop down door and a top mounted ceramic chimney. The combination of low thermal mass insulation and free radiating wire elements embedded in the chamber sides provide efficient heating.

Standard features

- 1100 °C maximum operating temperature
- Carbolite Gero 301 controller with single ramp to setpoint and process timer
- 6, 14 or 23 litre chamber volumes
- Drop down door with air gap to minimise external temperature
- Delayed start / process timer function as standard
- Vacuum formed, low thermal mass insulation
- Hard ceramic hearth fitted as standard
- Ventilated via top mounted ceramic chimney

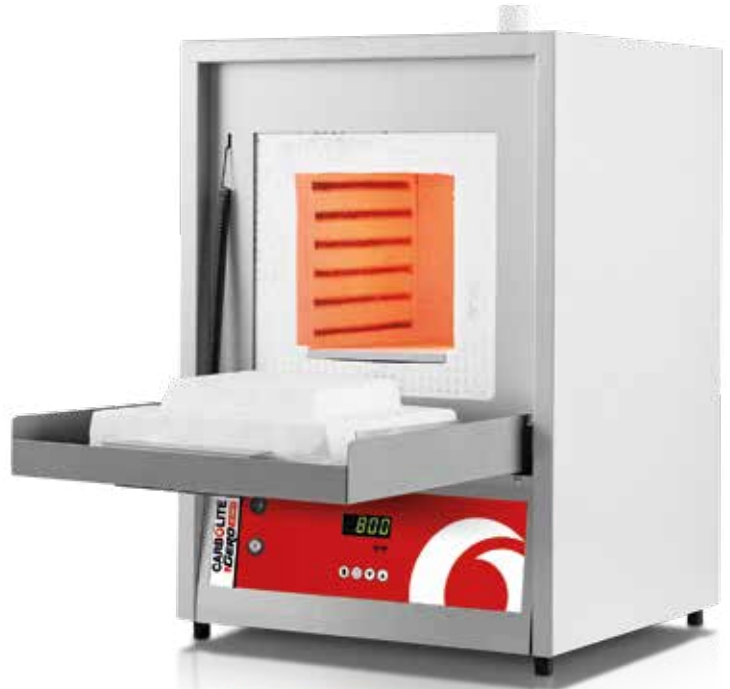

ELF 11/6

Options (specify these at time of order)

- Over-temperature protection (recommended to protect valuable contents & for unattended operation)

Heat-up and cool down rates for ELF 11/6

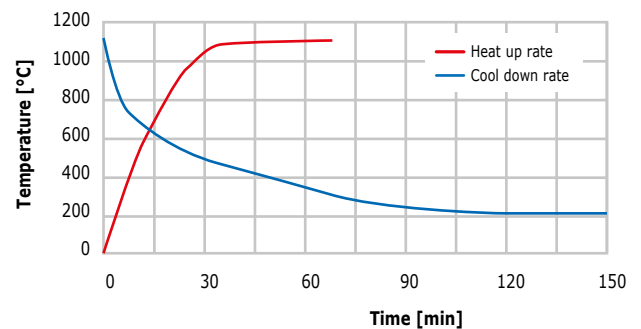

Technical data

Model	Max. temp. [°C]	Heat-up time [mins]	Max. continuous operating temp. [°C]	Dimensions: Usable chamber H x W x D [mm]	Dimensions: External H x W x D [mm]	Temperature uniformity of ±5 °C within H x W x D [mm]	Volume [litres]	Max. power [W]	Holding power [W]	Thermocouple type	Weight [kg]
ELF 11/6	1100	28	1000	165 x 180 x 210	580 x 410 x 420	125 x 140 x 140	6	2000	900	K	24
ELF 11/14	1100	43	1000	210 x 220 x 310	630 x 450 x 520	170 x 180 x 205	14	2600	1300	K	31
ELF 11/23	1100	26	1000	235 x 255 x 400	715 x 505 x 690	195 x 215 x 305	23	5000	1550	K	52

i Please note:
 - Heat up time is measured to 100°C below max, using an empty chamber
 - Holding power is measured at continuous operating temperature

- External dimensions with door closed and including chimney
 - The uniform volume is smaller than the total chamber volume

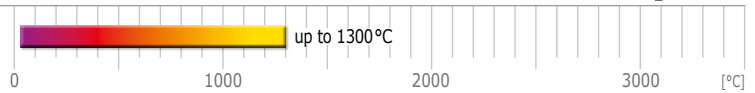

CFW, CWF-B and CWF-BAL Standard Chamber Furnaces

The CWF range of general purpose laboratory chamber furnaces is bench mounted. Models are available in five sizes with a maximum operating temperature up to 1300°C.

The airflow in the CWF-B furnaces is enhanced by the addition of air inlet holes in the door and a tall chimney which rapidly removes the fumes from the furnace.

Standard features

- Carbolite Gero 301 controller for CWF & CWF-B with single ramp to setpoint and process timer
- Soft closing door on 5, 13, 21 & 23 litre models
- Vertical lift door keeps heated surface away from the user
- Delayed start / process timer function as standard
- Hard wearing alumina element carriers, furnace entrance & hearth
- Energy efficient low thermal mass insulation
- Free radiating wire wound elements for optimum uniformity
- Easy access to elements & controls simplifies maintenance & servicing

CFW:

- 1100°C, 1200°C or 1300°C maximum operating temperature
- 5, 13, 23, 36 or 65 litre chamber volumes

CFW-B:

- Enhanced airflow from tall chimney & door vents for full combustion

CFW-BAL:

- 3216CC controller with single ramp to setpoint and process timer
- With integrated balance that runs independently of the furnace control system
- Software supplied with the balance may be used to monitor the balance reading via a computer
- Maximum capacity of balance is 3 kg with a resolution of 0.01 g (other capacities available)



CFW 11/13 with CC-T1 temperature programmer

The CWF-BAL furnace with integral balance can be used for thermogravimetric analysis (TGA) and loss on ignition (LOI) applications, where weight change of the sample must be monitored during the heating process. This is required, for example, in the determination of inorganic matter content in materials such as cement, lime, calcinated bauxite and refractories. For applications involving organic matter content, please refer to page 55 for the AAF-BAL.

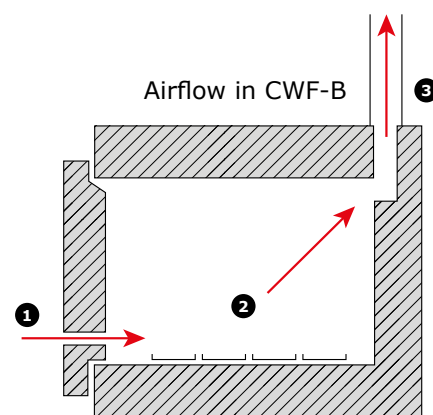

- 1) Air inlets through the door plug
- 2) Airflow through the chamber promotes burning of the samples

- 3) Chimney pulls air through the chamber

Options (specify these at time of order)

- A range of sophisticated digital controllers, multisegment programmers and data loggers with digital communication options is available (see page 100)
- Over-temperature protection (recommended to protect valuable contents & for unattended operation)
- A range of Inconel retorts to work with modified atmospheres up to 1100°C, please see page 32 for additional information
- AMS2750F Nadcap compatible models are available for aerospace applications
- CWF-BAL: 8 kg balance with a resolution of 0.1 g

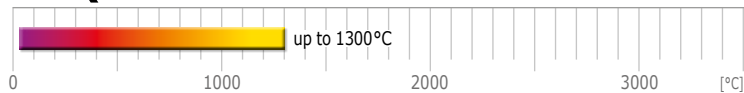

CFW, CWF-B and CWF-BAL Standard Chamber Furnaces



CWF 12/36 with EPC3016P1 programmer option



CWF-BAL 11/21 with optional Nanodac data logger

Technical data

CGH Model	Max. temp. [°C]	Heat-up time [mins]	Max. continuous operating temperature [°C]	Dimensions: Usable chamber H x W x D [mm]	Dimensions: External H x W x D [mm]	Dimensions: External with door open H x W x D [mm]	Temperature uniformity of $\pm 5^\circ\text{C}$ within H x W x D [mm]	Volume [litres]	Max. power [W]	Weight [kg]
Standard Chamber Furnaces										
CWF 11/5	1100	47	1000	135 x 140 x 250	585 x 375 x 485	800 x 375 x 485	85 x 90 x 110	5	2400	30
CWF 11/13	1100	76	1000	200 x 200 x 325	655 x 435 x 610	905 x 435 x 610	120 x 120 x 185	13	3100	47
CWF 11/23	1100	36	1000	235 x 245 x 400	705 x 505 x 675	990 x 505 x 675	155 x 165 x 285	23	7000	68
CWF 12/5	1200	51	1100	135 x 140 x 250	585 x 375 x 485	800 x 375 x 485	85 x 90 x 125	5	2400	30
CWF 12/13	1200	88	1100	200 x 200 x 325	655 x 435 x 610	905 x 435 x 610	120 x 120 x 200	13	3100	47
CWF 12/23	1200	45	1100	235 x 245 x 400	705 x 505 x 675	990 x 505 x 675	155 x 165 x 325	23	7000	68
CWF 12/36	1200	37	1100	250 x 320 x 450	810 x 690 x 780	1105 x 690 x 780	170 x 240 x 357	36	9000	100
CWF 12/65	1200	40	1100	278 x 388 x 595	885 x 780 x 945	1245 x 780 x 945	178 x 288 x 455	65	14000	165
CWF 13/5	1300	75	1200	135 x 140 x 250	585 x 375 x 485	800 x 375 x 485	85 x 90 x 150	5	2400	30
CWF 13/13	1300	121	1200	200 x 200 x 325	655 x 435 x 610	905 x 435 x 610	120 x 120 x 225	13	3100	47
CWF 13/23	1300	55	1200	235 x 245 x 400	705 x 505 x 675	990 x 505 x 675	155 x 165 x 340	23	7000	68
CWF 13/36	1300	47	1200	250 x 320 x 450	810 x 690 x 780	1105 x 690 x 780	170 x 240 x 400	36	9000	100
CWF 13/65	1300	45	1200	278 x 388 x 595	885 x 780 x 945	1245 x 780 x 945	178 x 288 x 520	65	14000	165
Burn-off Chamber Furnaces										
CWF-B 11/13	1100	103	1000	200 x 200 x 325	655 x 435 x 610	905 x 435 x 610	n/a	13	3100	47
CWF-B 12/13	1200	130	1100	200 x 200 x 325	655 x 435 x 610	905 x 435 x 610	n/a	13	3100	47
Chamber Furnace with Integral Balance										
CWF-BAL 11/21	1100	60	1000	215 x 245 x 400	705 x 505 x 675 (400 x 170 x 500)*	990 x 505 x 675	n/a	21	7000	80

i Please note:
 - Heat up time is measured to 100°C below max, using an empty chamber
 - Holding power is measured at continuous operating temperature
 - Maximum power and heat up time based on a 240 V supply

- The uniform volume is smaller than the total chamber volume
 * Dimensions of control box



Atmosphere Retorts for CWF Furnaces

A retort can be used for various heat treating processes requiring a controlled inert or reactive atmosphere, e.g. to prevent oxidation or to enhance surface hardness. The A105 retort, which incorporates a silicone rubber seal, can achieve lower oxygen levels than the A107 retort which uses a sand seal. Manufactured in either NiCr alloy (Inconel) with a maximum operating temperature of 1100 °C or 314 grade stainless steel with a maximum operating temperature of 1050 °C.

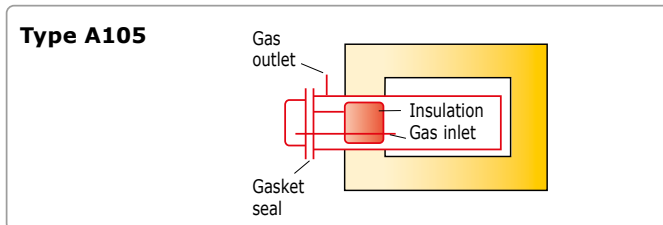

The A105 NiCr alloy (Inconel) retort is sealed by a removable front opening insulated door fitted with a silicone rubber seal. Gas inlet and outlet connections are easily accessible at the front. Oxygen levels down to 30 ppm are achievable. A105 retorts for CWF furnaces are fitted with a 3 mm thermocouple gland through the centre of the door. The retort and furnace must be ordered together as the furnace is modified to allow it to be used with, and without, the retort.

The A105 retort can be used in combination with the laboratory gas safety system for safe use with hydrogen (see page 114)

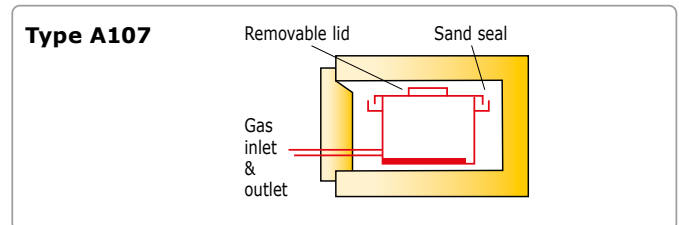

The A107 NiCr alloy (Inconel) retort with a shallow removable lid locates into a sand seal on top of a deep base. Can be used for annealing and pack carburising. Front mounted gas inlet/outlet connections extend through slots in the furnace door.

The retort and furnace must be ordered together as the furnace is modified to allow it to be used with, and without, the retort.



Technical data

A105 internal dimensions

CGH Model	Height h/H [mm]	Width W [mm]	Depth [mm]	Door type
CWF __/13	135/150	150	275	pull out
CWF __/23	170/185	195	350	pull out
CWF 12/36	180/200	270	400	pull out
CWF 12/65	200/225	335	540	pull out

A107 internal dimensions

CGH Model	Height h [mm]	Width W [mm]	Depth [mm]	Lid type
CWF __/13	130	140	255	lift off
CWF __/23	155	160	330	lift off
CWF 12/36	160	205	375	lift off
CWF 12/65	200	250	500	lift off

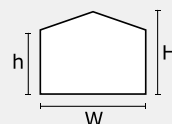



HRF – Air Recirculating Furnaces

The 750°C HRF air recirculation furnaces comprise two bench-mounted models and two floor-standing models.

Equipped with powerful fans and horizontal air-guides these models are intended to provide rapid heating with high thermal transfer to the chamber contents and high uniformity within the chamber.

These designs frequently form the base from which custom designed chambers with non-standard sizes or control configurations are made. HRF ovens are often supplied with modifications to enable heat treatment within AMS2750F Nadcap compliant production environments.



HRF 7/22 with EPC3016P1 programmer and over-temperature options

Standard features

- 750°C maximum operating temperature
- Programmable EPC3016P1 controller
- 22, 45, 112 or 324 litre chamber volumes
- Wire elements located in both sides of the chamber
- Stainless steel liner
- Combination of low thermal mass and refractory board insulation

Options (specify these at time of order)

- A range of sophisticated digital controllers, multisegment programmers and data loggers with digital communication options is available (see page 100)
- Over-temperature protection (recommended to protect valuable contents & for unattended operation)
- Additional sets of shelves & runners

Airflow in HRF

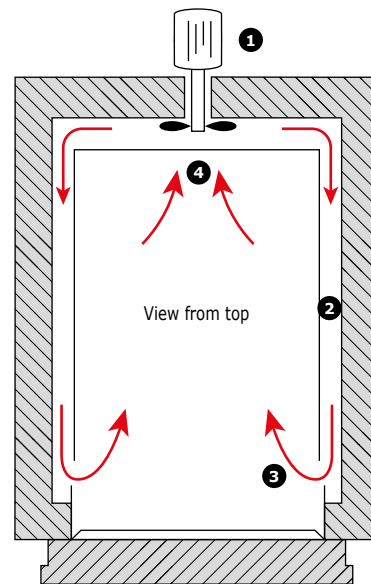

- 1) Air circulation fan
- 2) Heating elements heat the air
- 3) Heated air enters the chamber
- 4) Air from the chamber moves into the circulation fan

Technical data

Model	Max. temp. [°C]	Dimensions: Internal H x W x D [mm]	Dimensions: External H x W x D [mm]	Shelves fitted / accepted	Shelf loading each / total [kg]	Volume [litres]	Max. power [W]	Thermocouple type	Weight [kg]
HRF 7/22C	750	220 x 200 x 495	590 x 450 x 870 (Bench-top)	0 / 3	10 / 20	22	3000	K	61
HRF 7/45B	750	295 x 265 x 560	840 x 600 x 1000 (Bench-top)	0 / 3	10 / 20	45	6000	K	110
HRF 7/112	750	400 x 400 x 700	1550 x 1000 x 1600 (Floor-standing)	0 / 2	15 / 40	112	18000	K	480
HRF 7/324	750	600 x 600 x 900	1800 x 1200 x 2280 (Floor-standing)	1 / 1	50 / 50	324	24000	K	1000

i Please note:
 - External dimensions with door closed and including chimney
 - Heat up time is measured to 100°C below max, using an empty chamber

- Maximum power and heat up time based on a 240 V supply
 - HRF 7/22 and HRF 7/45 have 3 integral shelf runners

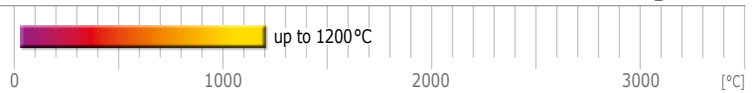

RWF – Rapid Heating Chamber Furnaces

The RWF rapid wire chamber furnaces are available in three chamber sizes with maximum operating temperatures of 1100 °C or 1200 °C.

The free radiating wire elements in combination with low thermal mass insulation are designed to provide rapid thermal response within the chamber.

Standard features

- 1100 °C or 1200 °C maximum operating temperature
- Carbolite Gero 301 controller, with single ramp to setpoint & process timer
- 5, 13 or 23 litre chamber volumes
- Ambient to 1000 °C in as little as 10 minutes
- Rapid thermal response from free radiating coiled wire elements
- Low thermal mass insulation for fast response & energy efficiency
- Soft closing vertical lift door keeps heated surface away from the user
- Hard wearing hearth

RWF 12/5



Options (specify these at time of order)

- A range of sophisticated digital controllers, multisegment programmers and data loggers with digital communication options is available (see page 100)
- Over-temperature protection (recommended to protect valuable contents & for unattended operation)

Heat-up and cool down rates
for RWF 12/13

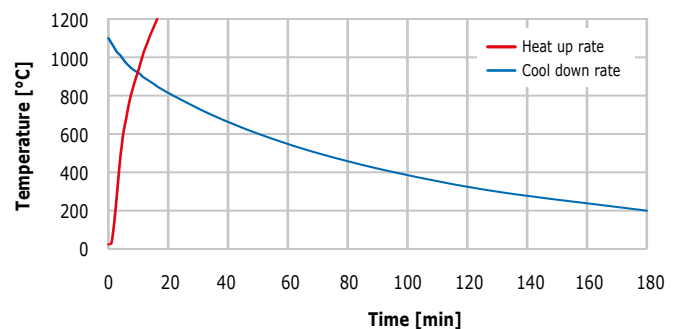

Technical data

CGH	Max. temp. [°C]	Heat-up time [mins]	Max. continuous operating temperature [°C]	Dimensions: Usable chamber H x W x D [mm]	Dimensions: External H x W x D [mm]	Dimensions: External with door open H x W x D [mm]	Volume [litres]	Max. power [W]	Holding power [W]	Thermocouple type	Weight [kg]
RWF 11/5	1100	10	1000	130 x 160 x 250	585 x 375 x 325	800 x 375 x 325	5	2750	680	K	28
RWF 11/13	1100	11	1000	195 x 210 x 325	655 x 435 x 610	905 x 435 x 610	13	5000	1200	K	45
RWF 11/23	1100	13	1000	220 x 260 x 400	705 x 505 x 675	990 x 505 x 675	23	9100	1800	K	65
RWF 12/5	1200	12	1100	130 x 160 x 250	585 x 375 x 485	800 x 375 x 485	5	2750	820	R	28
RWF 12/13	1200	13	1100	195 x 210 x 325	655 x 435 x 610	905 x 435 x 610	13	5000	1450	R	45
RWF 12/23	1200	15	1100	220 x 260 x 400	705 x 505 x 675	990 x 505 x 675	23	9100	2100	R	65

i Please note:

- Heat up time is measured to 100 °C below max, using an empty chamber
- Holding power is measured at continuous operating temperature

- Maximum power and heat up time based on a 240 V supply
- The uniform volume is smaller than the total chamber volume

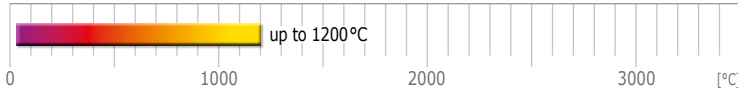

VCF – Top Loading Chamber Furnaces

These top loading chamber furnaces are particularly suited for applications involving tall crucibles and heavy components.

Heating elements in all four walls minimise the risk of damage from spills and ensures good temperature uniformity. The smaller two furnaces may be bench-mounted, but best access is provided when these furnaces are located on the floor.

Standard features

- 1200 °C maximum operating temperature
- Carbolite Gero 301 controller with single ramp to setpoint & process timer
- 5, 10, 23 or 100 litre chamber volume
- Free radiating wire elements in all 4 sides of chamber
- Vented top opening door
- Angled control panel, protected but clearly visible
- Thermocouple protected by ceramic sheath



VCF 12/5 with EPC3008P10 programmer option

Options (specify these at time of order)

- A range of sophisticated digital controllers, multisegment programmers and data loggers with digital communication options is available (see page 100)
- Over-temperature protection (recommended to protect valuable contents & for unattended operation)

Technical data

CGH Model	Max. temp. [°C]	Heat-up time [mins]	Dimensions: Usable chamber H x W x D [mm]	Dimensions: External H x W x D [mm]	Volume [litres]	Max. power [W]	Holding power [W]	Thermocouple type	Weight [kg]
VCF 12/5	1200	102	260 x 155 x 130	660 x 530 x 405 (Floor-standing)	5	2500	900	R	50
VCF 12/10	1200	138	365 x 180 x 155	765 x 600 x 430 (Floor-standing)	10	3000	1200	R	60
VCF 12/23	1200	125	450 x 250 x 200	850 x 600 x 500 (Floor-standing)	23	6000	2500	R	130
VCF 12/100	1200	150	600 x 410 x 410	1100 x 930 x 950 (Floor-standing)	100	15000	6000	R	200

i Please note:
 - Maximum continuous operating temperature is 100°C below maximum temperature
 - Heat up time is measured to 100°C below max, using an empty chamber

- Holding power is measured at continuous operating temperature
 - The uniform volume is smaller than the total chamber volume

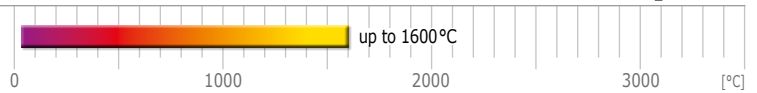

RHF – High Temperature Chamber Furnaces

The RHF range of silicon carbide heated high temperature chamber furnaces comprises four chamber sizes, each available with three maximum operating temperatures of 1400 °C, 1500 °C and 1600 °C.

Robust construction and high quality elements provide rapid heating rates (typically reaching 1400 °C in under 40 minutes) and a long reliable working life.

Standard features

- 1400 °C, 1500 °C or 1600 °C maximum operating temperature
- Carbolite Gero 301 PID controller with single ramp to setpoint & process timer
- 3, 8, 15 or 35 litre chamber volumes
- Soft closing vertical lift door (3 & 8 litre models only)
- Silicon carbide heating elements provide long life and are able to withstand the stresses of intermittent operation
- RHF 3 & 8 litre have a cast alumina hearth
RHF 15 & 35 have silicon carbide hearth
- Low thermal mass insulation for energy efficiency & rapid heating & cooling



RHF 15/3 with EPC3008P10 programmer option



RHF 16/35 with EPC3016P1 programmer and over-temperature options

Options (specify these at time of order)

- A range of sophisticated digital controllers, multisegment programmers and data loggers with digital communication options is available (see page 100)
- Over-temperature protection (recommended to protect valuable contents & for unattended operation)
- Silicon carbide protection tiles (see details on the opposite page)

Power supplies for RHF furnaces

A characteristic of the control systems used with silicon carbide elements results in a power supply which will be larger than expected e.g. RHF 14/3 at 4500 W =

- Single phase / 200–240 V / 30 A or
- 2 phase / 380–415 V / 15 A per phase.

See pages 120–123 for power supply information.

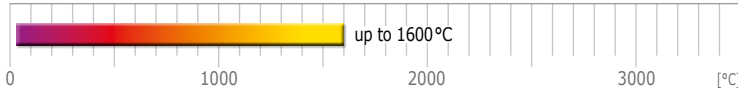

SiC Protection Tile Option

The RHF chamber furnace range is available with optional heating element protection tiles. When this option is specified, silicon carbide (SiC) tiles are added to the insulation assembly, positioned on both sides of the chamber to create a barrier between the working chamber and the heating elements. This will protect the heating elements from potentially harmful contaminants that might be placed in the chamber.

The addition of the heating element protection tiles option reduces the width of the internal chamber and the maximum operating temperature. The table below shows the amended technical data.

Technical data (SiC option)

Model	Max. temp. [°C]	Dimensions: Usable chamber H x W x D [mm]	Volume [litres]
RHF 14/3	1300	120 x 80 x 205	2
RHF 14/8	1300	170 x 130 x 270	6
RHF 14/15	1300	220 x 180 x 310	12
RHF 14/35	1300	250 x 260 x 465	30
RHF 15/3	1400	120 x 80 x 205	2
RHF 15/8	1400	170 x 130 x 270	6
RHF 15/15	1400	220 x 180 x 310	12
RHF 15/35	1400	250 x 260 x 465	30
RHF 16/3	1500	120 x 80 x 205	2
RHF 16/8	1500	170 x 130 x 270	6
RHF 16/15	1500	220 x 180 x 310	12

Application examples

- If the process creates small amounts of acid, NOx or water.
- Burn-off processes which create a lot of fumes.
- Melting different kinds of glass which emit aggressive gases.
- This option can also be specified in combination with a gas inlet where the user requires reduced oxygen content in the chamber. The protection tiles prevent gases leaking out of the chamber through the double spiral heating elements.

Note: The additional protection tiles reduce the width of the standard chamber, and reduce the maximum temperature achievable in the chamber.

RHF chamber with SiC protection tiles

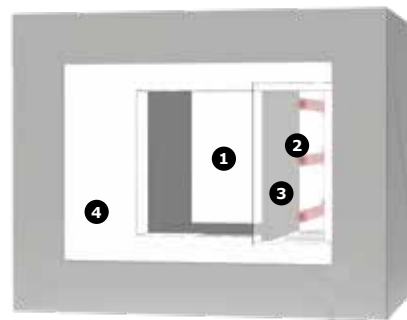

- 1) Working chamber
- 2) Heating elements
- 3) SiC protection tiles
- 4) Thermal insulation

Technical data

CGH Model	Max. temp. [°C]	Heat-up time [mins]	Dimensions: Usable chamber H x W x D [mm]	Dimensions: External with door open H x W x D [mm]	Volume [litres]	Holding power [W]	Max. power [W]	Thermo-couple type	Weight [kg]
RHF 14/3	1400	33	120 x 120 x 205	655 x 435 x 610 (905) (Bench-top)	3	1900	4500	R	42
RHF 14/8	1400	22	170 x 170 x 270	705 x 505 x 675 (990) (Bench-top)	8	3200	8000	R	64
RHF 14/15	1400	35	220 x 220 x 310	810 x 690 x 780 (1105) (Bench-top)	15	2900	10000	R	125
RHF 14/35	1400	38	250 x 300 x 465	885 x 780 x 945 (1245) (Bench-top)	35	6000	16000	R	179
RHF 15/3	1500	45	120 x 120 x 205	655 x 435 x 610 (905) (Bench-top)	3	2000	4500	R	46
RHF 15/8	1500	40	170 x 170 x 270	705 x 505 x 675 (990) (Bench-top)	8	3500	8000	R	61
RHF 15/15	1500	46	220 x 220 x 310	810 x 690 x 780 (1105) (Bench-top)	15	3000	10000	R	125
RHF 15/35	1500	46	250 x 300 x 465	885 x 780 x 945 (1245) (Bench-top)	35	6200	16000	R	178
RHF 16/3	1600	42	120 x 120 x 205	655 x 435 x 610 (905) (Bench-top)	3	2300	4500	R	42
RHF 16/8	1600	35	170 x 170 x 270	705 x 505 x 675 (990) (Bench-top)	8	4000	8000	R	61
RHF 16/15	1600	58	220 x 220 x 310	810 x 690 x 780 (1105) (Bench-top)	15	3500	10000	R	140
RHF 16/35	1600	113	250 x 300 x 465	1530 x 900 x 1020 (1885) (Floor-standing)	35	7000	16000	R	270

i Please note:
 - Maximum continuous operating temperature is 100°C below maximum temperature
 - Heat up time is measured to 100°C below max, using an empty chamber

- Holding power is measured at continuous operating temperature

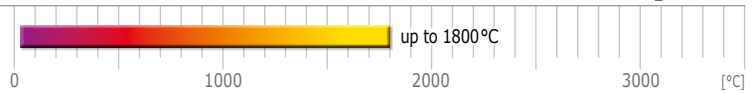

BLF – High Temperature Bottom Loading Furnaces

BLF bottom loading furnaces use an electrically operated elevator hearth, which as it rises into the furnace chamber, lifts the load into the heated zone.

This furnace provides the following advantages: easy loading of samples and uniform heating achieved by locating elements in all six side walls of the chamber.

Standard features

- 1600°C, 1700°C & 1800°C maximum operating temperature
- Programmable EPC3016P1 controller
- 3 to 21 litre capacities
- Ideal for: sintering high performance ceramics, melting glass under high temperature or working with modified atmospheres
- Rapid heating & cooling cycles can be achieved through raising & lowering the hearth
- Electrically operated elevator hearth protects operator from the chamber's radiant heat
- Hearth cage with safety interlock
- Excellent temperature uniformity as a result of the hexagonal chamber
- Over-temperature protection to protect load or furnace during unattended operation
- 1600°C model heated by silicon carbide elements
- 1700°C & 1800°C models heated by molybdenum disilicide elements
- **NEW** Ethernet communications



BLF 17/3 with optional CC-T1 touchscreen programmer

The 1600°C is ideal for sintering of zirconia dental crowns and frameworks. The silicon carbide heating elements will not cause discolouration of the zirconia.

Options (specify these at time of order)

- A range of sophisticated digital controllers, multisegment programmers and data loggers with digital communication options is available (see page 100)
- Compatible crucibles
- Modified hearth for the introduction of gases into an inverted crucible (not gas tight)
- Radiation shutter
- Customised options including: adaptation to introduce thermocouple or stirrer through the chamber roof and rotating hearth
- Plasma sprayed alumina protection tube to protect heating elements from sample contamination

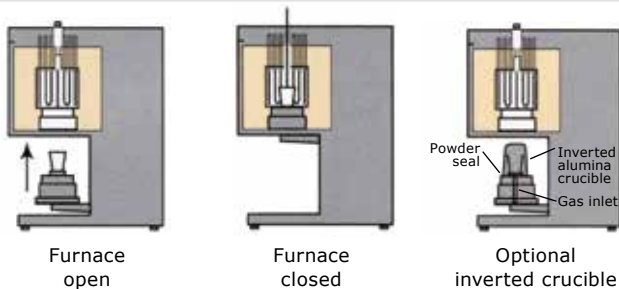

Technical data

CGH Model	Max. temp. [°C]	Heat-up time [mins]	Dimensions: Usable chamber H x Diameter [mm]	Dimensions: External H x W x D [mm]	Volume [litres]	Max. power [W]	Thermocouple type	Weight [kg]
BLF 16/3	1600	80	190 x 150	1025 x 750 x 530 (Bench-top)	3	6000	R	155
BLF 17/3	1700	80	190 x 150	975 x 750 x 530 (Bench-top)	3	4125	B	155
BLF 17/8	1700	80	250 x 200	1950 x 1360 x 880 (Floor-standing)	8	8130	B	424
BLF 17/21	1700	180	300 x 300	1850 x 1250 x 900 (Floor-standing)	21	12000	B	600
BLF 18/3	1800	112	190 x 150	975 x 750 x 530 (Bench-top)	3	4775	Pt20%Rh/Pt40%Rh	155
BLF 18/8	1800	110	250 x 200	1950 x 1360 x 880 (Floor-standing)	8	7010	Pt20%Rh/Pt40%Rh	424
BLF 18/21	1800	220	300 x 300	1850 x 1250 x 900 (Floor-standing)	21	12000	Pt20%Rh/Pt40%Rh	600

i Please note:

- Maximum continuous operating temperature is 100°C below maximum temperature
- Heat up time is measured to 100°C below max, using an empty hearth

- For 1700°C and 1800°C models, a chemical reaction between the heating elements and zirconia may discolour the zirconia. Processing advice or alternative elements are available; please enquire.

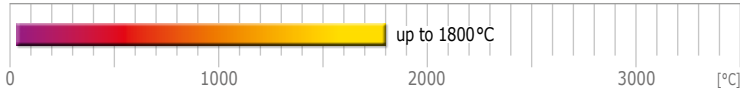

HTF – High Temperature Laboratory Chamber Furnaces

The laboratory HTF high temperature chamber furnace range comprises 1700°C and 1800°C models.

These furnaces may be customised in order to satisfy specific customer requirements, e.g. the addition of catalytic afterburners for ceramic binder burn-off applications.

Standard features

- 1700°C & 1800°C maximum operating temperatures
- Programmable EPC3016P1 controller
- From 4 to 10 litre capacities
- High quality molybdenum disilicide heating elements
- Vertical lift door keeps hot face away from user
- Advanced refractory interior, used in combination with energy efficient low thermal mass insulation
- Over-temperature protection
- Fan cooling for low external case temperature
- **NEW** Ethernet communications



HTF 17/5 with optional touchscreen programmer

Cool down rates for HTF 17/10

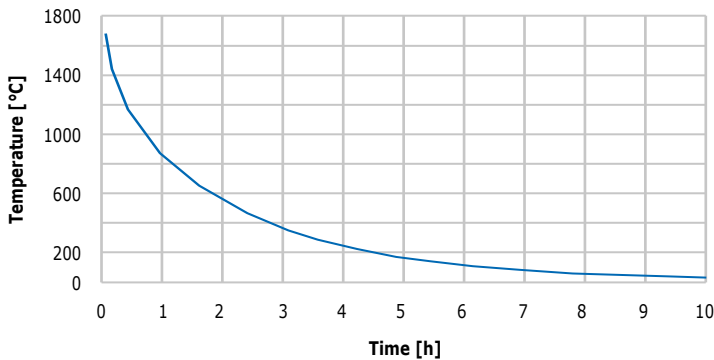

Options (specify these at time of order)

- A range of sophisticated digital controllers, multisegment programmers and data loggers with digital communication options is available (see page 100)

Technical data

CGH Model	Max. temp. [°C]	Heat-up time [mins]	Dimensions: Usable chamber H x W x D [mm]	Dimensions: External with door open H x W x D [mm]	Volume [litres]	Max. power [W]	Thermocouple type	Weight [kg]
HTF 17/5	1700	50	158 x 150 x 225	565 x 830 x 650 (850) (Bench-top)	5	4050	B	109
HTF 17/10	1700	44	232 x 200 x 225	565 x 830 x 650 (850) (Bench-top)	10	5920	B	133
HTF 18/4	1800	65	140 x 140 x 190	565 x 830 x 650 (850) (Bench-top)	4	4650	Pt20%Rh/Pt40%Rh	115
HTF 18/8	1800	56	210 x 190 x 190	565 x 830 x 650 (850) (Bench-top)	8	6200	Pt20%Rh/Pt40%Rh	128

i Please note:
 - Maximum continuous operating temperature is 100°C below maximum temperature
 - Heat up time is measured to 100°C below max, using an empty chamber

- Chemical reaction between the heating elements and zirconia may discolour the zirconia. Processing advice or alternative elements are available; please enquire.

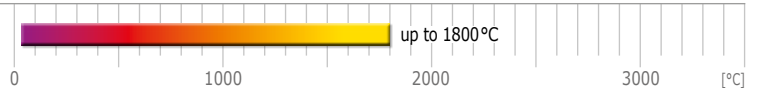

HTF – High Temperature Industrial Chamber Furnaces

The industrial HTF chamber furnace is available in usable volumes of 27 to 560 litres.

Standard features

- 1600 °C, 1700 °C & 1800 °C maximum operating temperatures
- Programmable EPC3016P1 controller
- From 27 to 560 litre capacities
- High quality molybdenum disilicide heating elements
- Advanced refractory interior, used in combination with energy efficient low thermal mass insulation
- Over-temperature protection
- Automatic movement of the door
- Controller mounted on a user-friendly satellite
- Compact design
- Debinding options on request
- **NEW** Ethernet communications



HTF 17/64 with Mini8 touchscreen controller

Sinter run in HTF 18/64

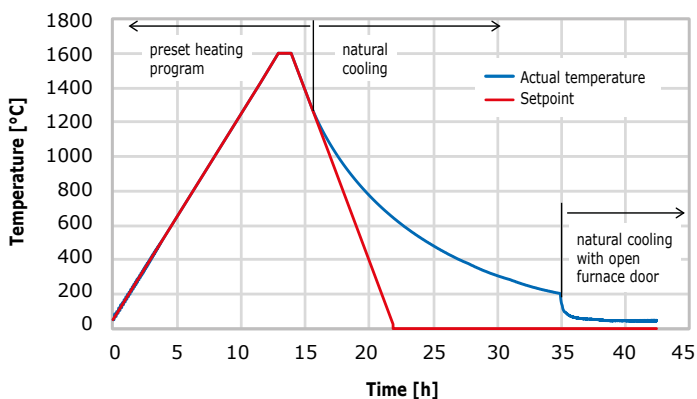

Disclaimer: The information presented shows typical performance. Furnace load ~8 kg.

Options (specify these at time of order)

- A range of sophisticated digital controllers, multi-segment programmers and data loggers is available
- Gas supply with manually adjustable flow meter is available
- Modification of the atmosphere in the furnace chamber can be achieved but oxygen cannot be removed completely because it is not gas tight
- Fast cooling option to reduce the natural cool down time below 600 °C
- Current voltage display

Technical data

CGN	Max. temp. [°C]	Max. heat-up rate [°C/min]	Cooling time [h]	Dimensions: Usable chamber H x W x D [mm]	Dimensions: External H x W x D [mm]	Volume [litres]	Max. power [W]
HTF__/27	1700, 1800	10	10	300 x 300 x 300	1610 x 780 x 945	27	10000
HTF__/64	1600, 1700, 1800	10	12	400 x 400 x 400	2000 x 1000 x 1200	64	16000
HTF__/128	1600, 1700, 1800	10	12	400 x 400 x 800	2000 x 1000 x 1500	128	40000
HTF__/165	1600, 1700, 1800	10	13	550 x 550 x 550	2450 x 1400 x 1400	166	40000
HTF__/240	1600, 1700, 1800	10	14	500 x 500 x 1000	2000 x 1000 x 1500	250	-
HTF__/430	1600, 1700, 1800	-	-	600 x 600 x 1200	2400 x 1500 x 2000	432	-
HTF__/560	1600, 1700, 1800	-	-	780 x 600 x 1200	2400 x 1500 x 2000	561	-

i Please note:
 - Maximum continuous operating temperature is 100 °C below maximum temperature

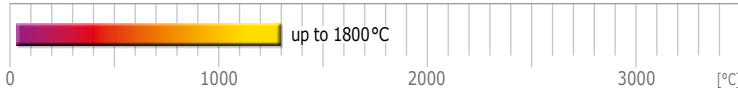

Fast cooling options

The fast cooling options include either one, two or three fans each with 1000 NI/min air flow. The cooling fans can only be started once the temperature is below 600°C. The extraction system used (supplied by the customer) must be capable of 1300, 2600, or 3900 NI/min respectively. Note: The controller needs to be 3508, EPC3008P10, CC-T1 or nanodac, when the fast cooling option is required. For information on the debinding options please contact Carbolite Gero.

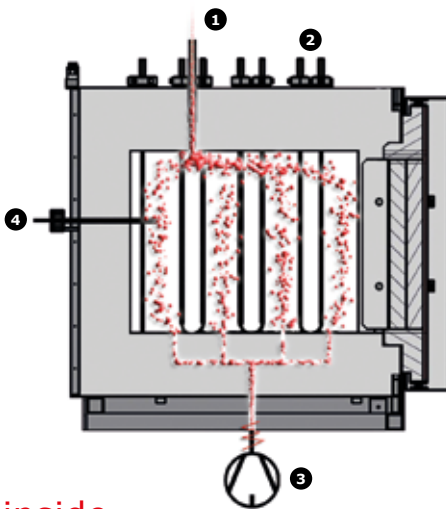

View inside

- 1) Gas outlet
- 2) MoSi₂ heating elements
- 3) Hot/cold air inlet blower
- 4) Thermocouple



HTF 17/64 with debinding option incl. active propane afterburner and Mini8 touchscreen controller

Cool down rates for HTF 17/430

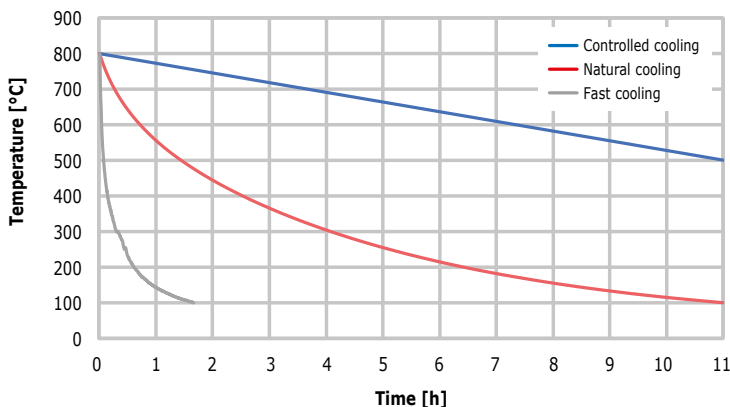

- 1) Thermal afterburner gas fired
- 2) Air and propane/natural gas supply system for afterburner
- 3) Heated pipe (gas outlet furnace)
- 4) Side channel blower
- 5) Pre-Heater
- 6) Air filter

Equipment for fast cooling (blue) and debinding option (red) of HTF 17/64. (gas flow monitor not shown)

Temperature uniformity (HTF 18/64)

- Uniformity dimensions: H x W x D = 315 x 340 x 340 mm
- Distance from hearth: 38 mm
- Distance from door: 80 mm
- Central loading
- Temperature uniformity @1600°C in air ± 7,5 °C

Disclaimer: The information presented shows typical performance.



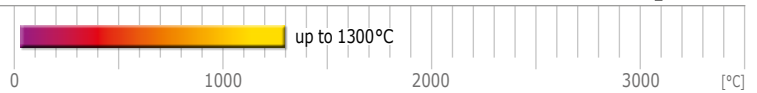

GPC – General Purpose Chamber Furnaces

The GPC general purpose chamber furnaces are larger floor-standing models. Available at 1200°C and 1300°C with capacities ranging from 131 to 400 litres.

Standard features

- 1200°C or 1300°C maximum operating temperature
- Programmable EPC3016P1 controller
- Over-temperature protection
- 131, 200, 225, 300, 350 or 400 litre chamber volumes
- Free radiating coiled wire elements on two sides and roof
- All models have under hearth heating
- Low thermal mass insulation for fast response & energy efficiency
- Up & away door keeps heated surface away from the user
- Hard wearing refractory hearth plate resists damage & supports heavier loads
- Heating elements are easily serviced
- **NEW** Ethernet communications



GPC 12/131 with optional custom built sample support rack

Options (specify these at time of order)

- A range of sophisticated digital controllers, multisegment programmers and data loggers with digital communication options is available (see page 100)
- AMS2750F Nadcap compatible models are available for aerospace applications
- Various loading and unloading management options can be supplied

Technical data

CGH	Max. temp. [°C]	Heat-up time [mins]	Max. continuous operating temperature [°C]	Dimensions: Usable chamber H x W x D [mm]	Dimensions: External (with door open) H x W x D [mm]	Volume [litres]	Max. power [W]	Thermocouple type	Weight [kg]
GPC 12/131B	1200	150	1100	350 x 500 x 750	1860 x 1260 x 1230 (1860)	131	24000	R	400
GPC 12/200B	1200	-	1100	400 x 600 x 900	1930 x 1360 x 1380 (1930)	200	30000	R	518
GPC 12/225B	1200	150	1100	600 x 500 x 750	2130 x 1260 x 1230	225	33000	R	560
GPC 12/300B	1200	-	1100	550 x 600 x 900	2080 x 1360 x 1380 (2080)	300	36000	R	600
GPC 12/350B	1200	-	1100	550 x 600 x 1050	2080 x 1360 x 1530 (2080)	350	39000	R	650
GPC 12/400B	1200	150	1100	675 x 650 x 900	2200 x 1410 x 1380	400	39000	R	670
GPC 13/131B	1300	-	1200	350 x 500 x 750	1860 x 1260 x 1230 (1860)	131	24000	R	400
GPC 13/200B	1300	-	1200	400 x 600 x 900	1930 x 1360 x 1380 (1930)	200	30000	R	518
GPC 13/225B	1300	150	1200	600 x 500 x 750	2130 x 1260 x 1230	225	33000	R	560
GPC 13/300B	1300	-	1200	550 x 600 x 900	2080 x 1360 x 1380 (2080)	300	36000	R	600
GPC 13/350B	1300	-	1200	550 x 600 x 1050	2080 x 1360 x 1530 (2080)	350	39000	R	650
GPC 13/400B	1300	150	1200	675 x 650 x 900	2200 x 1410 x 1380	400	39000	R	670

i Please note:

- Heat up time is measured to 100°C below max, using an empty chamber
- Holding power is measured at continuous operating temperature

The following models GPC 12/36, GPC 13/36, GPC 12/65 & GPC 13/65 have been renamed CWF; see page 30 of the catalogue.

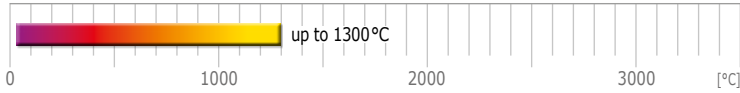

GPC A107 Retorts

A retort can be used for various heat treating processes requiring a controlled inert or reactive atmosphere, e. g. to prevent oxidation or to enhance surface hardness. Manufactured in either NiCr alloy (Inconel) with a maximum operating temperature of 1100 °C or 314 (1.4841) grade stainless steel with a maximum operating temperature of 1050 °C.

The A107 retort can be removed from the chamber onto a cooling cart for applications that require accelerated cooling.



Charging & Cooling Cart

Standard features

- The A107 retort has a shallow removable lid located into a seal channel on the top edge of a deep base. Applications include annealing and pack carburising. Front mounted gas inlet/outlet connections extend through slots in the furnace door.
- Gas enters under a perforated mesh base within the retort box.
- Lid clamping arrangement to hold the lid onto the ceramic seal.
- The retort and furnace must be ordered together as the furnace is modified to allow it to be used with, and without, the retort.
- Loading of the A107 retort can be done by using the optional charging cart or by fork lift truck
- The A107 retort can be removed from the chamber onto a cooling cart for applications that require accelerated cooling.

Options

- Charging cart aligns the A107 retort with the furnace hearth to assist the loading and unloading
- Charging & cooling cart. The cooling of the A107 retort can be further accelerated by use of the cooling fan mounted to the cart
- Stacker truck for loading and unloading
- Semi-automatic gas system with analogue flowmeters for argon
- Semi-automatic gas system with digital flowmeters (will be data logged if a data logger option is selected)
- Automatic gas system with gas monitoring and control with mass flow controllers
- Oxygen monitoring system requires EPC3008P10 or nanodac



A107 retort for GPC chamber furnace



Gas flow enters below the internal perforated base

Technical data

CGH Model	Loading type	Height [mm]	Width [mm]	Depth [mm]	Volume [litres]
GPC __/131	Pull onto cart	225	300	336	22.5
GPC __/131	Pull onto cart or lift	175	300	336	17.5
GPC __/200	Pull onto cart or lift	225	400	486	43.5
GPC __/225	Pull onto cart or lift	350	250	250	22
GPC __/300 & 350	Pull onto cart or lift	375	400	486	73
GPC __/400	Pull onto cart or lift	400	400	400	64

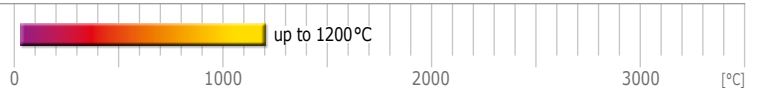

GPCMA - Modified Atmosphere Chamber Furnaces

Our GPCMA chamber furnaces are equipped with a metallic retort to provide a uniform heated volume with a controlled atmosphere. These floor-standing models have a smooth action double pivot door. Available with a range of maximum temperatures from 1000 °C to 1150 °C depending on the selected retort material. Retort working volumes range from 37 to 245 litres. Oxygen levels can be reduced to 30 ppm depending on the application. Perfect for stress relieving additive manufactured components particularly those produced via DMLS. This range of furnaces can be optionally specified for compliance to AMS2750F Nadcap Class 1 for aerospace applications.

Applications

- Stress relieving 3D printed additive manufactured parts



GPCMA/174 with semi automatic gas system with digital flowmeters and data logging options

Standard features

- A range of maximum temperatures dependent on retort material:
 - 310 Stainless Steel retort 1000°C maximum
 - 314 Stainless Steel retort 1050°C maximum
 - Inconel retort 1100°C maximum
 - Haynes 230 retort 1150°C maximum
- Programmable 3508P1 controller
- 2-zone cascade control
- Over-temperature protection
- 37, 56, 117, 174, 208, or 245 litre retort volume
- Semi-automatic gas system with analogue flowmeters for nitrogen
- Free radiating coiled wire elements on two sides, the roof and under the hearth (37 litre: two sides and under hearth)
- Low thermal mass insulation for fast response & energy efficiency
- Smooth action double pivot door shields the user from excessive heat
- Type R control thermocouples
- Internal retort thermocouple: type K up to 1100 °C, type N above 1100 °C
- Silicone rubber water cooled door seal
- Door safety interlock

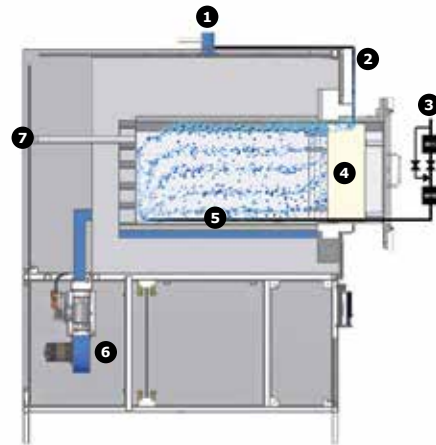

View inside

- 1) Outlet fast cooling
- 2) Gas outlet
- 3) Gas inlet system
- 4) Door insulation plug
- 5) Retort
- 6) Side channel blower
- 7) Optional TUS port

Options (specify these at time of order)

- Vacuum option (10^{-2} mbar) for faster atmosphere exchange **at room temperature only**. A vacuum retort **MUST** be ordered with this option
- Semi-automatic gas system with analogue flowmeters for argon
- Semi-automatic gas system with digital flowmeters (will be data logged if a data logger option is selected)
- Automatic gas system with gas monitoring and control with mass flow controllers
- Oxygen monitoring system with 3504 programmer
- Automatic forced cooling system
- Afterburner option (NOT compatible with vacuum option/ vacuum retorts)
- Chiller unit, 5 litre/min, 1 kW.
- A range of sophisticated digital controllers, multi-segment programmers and data loggers is available. These can be fitted with RS232, RS485 or Ethernet communications (see page 100)
- AMS2750F Nadcap compatible models are available
- Various loading and unloading options can be supplied

GPCMA retort internal dimensions

Model	Height h/H [mm]	Width W [mm]	Depth [mm]
GPCMA/37	205/230	337	538
GPCMA/56	238/295	400	665
GPCMA/117	278/345	500	815
GPCMA/174	428/495	500	815
GPCMA/208	428/495	500	965
GPCMA/245	500/574	600	815

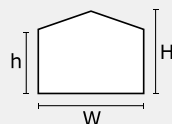

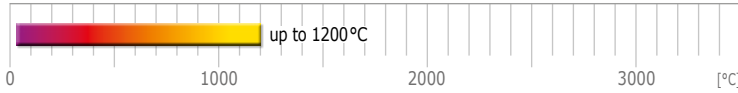

GPCH2 - Hydrogen Atmosphere

The Carbolite Gero GPCH2 furnaces are designed specifically for use with a hydrogen atmosphere. The GPCH2 furnace range has the same retort capacities as the GPCMA furnace range and incorporates all the safety equipment required for safe use with hydrogen.

Please refer to the Carbolite Gero GPCH2 product range which is detailed in the 'Vacuum, Inert and Reactive Gas Furnaces catalogue'.

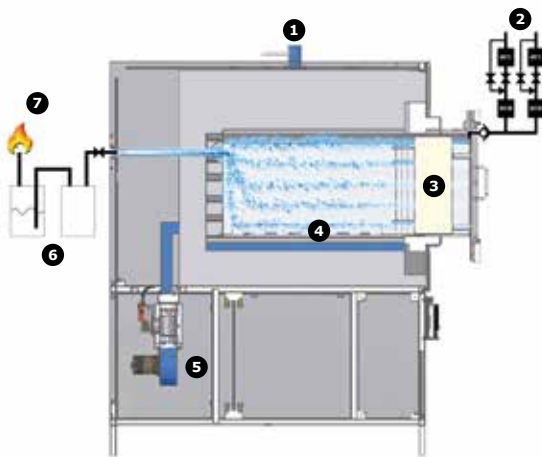

View inside

- 1) Outlet fast cooling
- 2) Gas inlet system
- 3) Door insulation plug
- 4) Retort
- 5) Side channel blower
- 6) Water bubbler
- 7) Ignition burner H₂

Temperature Uniformity

- Can achieve AMS2750F Class 1, instrument type B: ± 3°C

Temperature and atmosphere requirements for AM metals heat treatment

Carbolite Gero product range	Material	Temperature	Atmosphere
HTMA (see page 22)	Aluminium	500°C	Air or inert gas
GPCMA	Titanium	900°C - 1100°C	Argon
GPCMA	Tool Steel	900°C - 1100°C	Argon
GPCMA	Co/Cr	1150°C	Argon
GLO with fast cooling option see vacuum catalogue	Inconel 718	960°C & 1060°C Requires fast cooling to 200°C. (2-4 hrs)	Argon
GPCMA	Ti-6Al-4V	750°C - 950°C	Argon
GPCMA	Inconel 625	900°C	Argon
GPCMA	Copper alloys	900°C	Argon



GPCH2

Furnace capacity for typical AM base plate sizes

Model	Retort capacity Plate size 350 x 250 x 250 (H x W x D) [mm]	Retort capacity Plate size 400 x 400 x 400 (H x W x D) [mm]
GPCMA/37	1 plate, max height 100 mm	Not applicable
GPCMA/56	1 plate, max height 150 mm	Not applicable
GPCMA/117	2 plates, max height 200 mm	1 plate, max height 200 mm
GPCMA/174	2 plates, max height 350 mm	1 plate, max height 350 mm
GPCMA/208	3 plates, max height 350 mm	2 plate, max height 350 mm
GPCMA/245	4 plates, max height 400 mm	1 plate, max height 400 mm



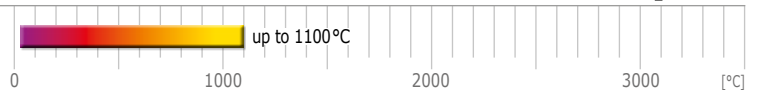

GLO – Annealing Furnaces

The GLO features a vacuum tight retort with symmetrical positioning of the heating elements. The heating elements are made of CrFeAl, also known as APM, and are embedded in ceramic fibre insulation.

The unique design

- Space saving
- Low leakage rate
- Water cooled door flange
- Hot wall design suited for debinding processes

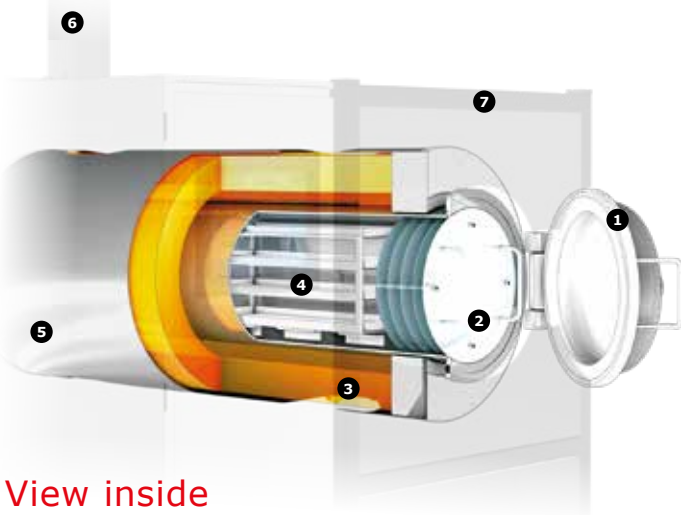

View inside

- | | |
|--|------------------------------|
| 1) Open door | 4) Charging rack |
| 2) Radiation shields | 5) Thin metallic surrounding |
| 3) Ceramic fibre insulation and heating elements | 6) Afterburner |
| | 7) Frame |

Options (specify these at time of order)

- A range of sophisticated digital controllers, multisegment programmers and data loggers with digital communication options is available (see page 100). Please note that special controllers may be needed for this model
- Complete automation using Siemens SPS control with touch panel and mass flow controller for the gases
- Controls for multiple gases
- Charging racks
- Other retort sizes on request
- Other retort material e.g. Inconel
- Fast cooling system
- Vacuum pumps
- Gas packages for explosive or dangerous gases e.g. pure hydrogen with comprehensive safety features
- Debinding package with propane gas fired afterburner
- Heated front door
- Heated gas outlet
- Water chiller for water cooling system if cooling water is not available at customer site



GLO 10/11-1G:
Compact hot wall furnace with stainless steel retort and optional inconel retort

Forced vs. natural cooling

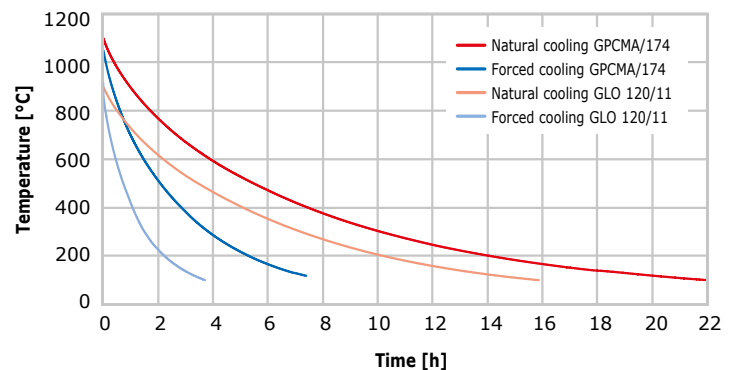

Standard features

- Manual control
- Gas tight retort made of 1.4841 (equals grade 314) stainless steel
- Water cooled door with gas tight rubber sealing (water cooling must be provided at customer site)
- Radiation shields
- Gas control with manual control for a single inert gas, air or formation gas
- Precisely controlled atmosphere with highest possible purity
- Over-temperature protection (recommended to protect valuable contents & for unattended operation)

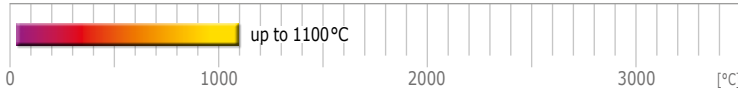

GLO with Hydrogen Atmosphere

The GLO can be equipped for the safe use of reactive gases such as H₂. More details are provided in the 'Vacuum, Inert and Reactive Gas Furnaces catalogue'.



GLO 120 equipped for H₂

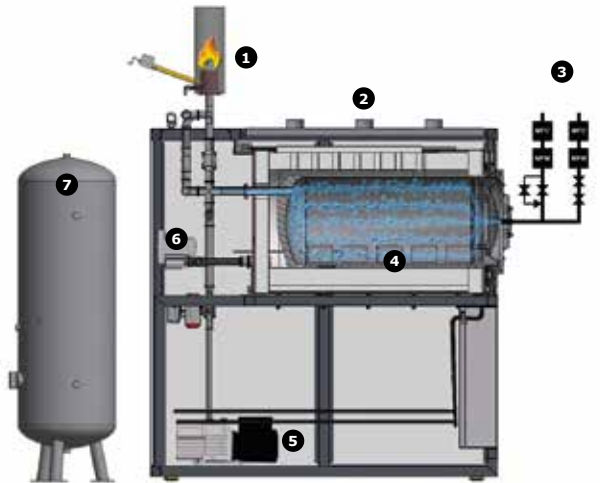

View inside

- 1) Afterburner
- 2) Outlets fast cooling
- 3) Gas inlet system
- 4) Retort
- 5) Vacuum pump
- 6) Side channel blower
- 7) Safety tank

Technical data

Model	Retort volume [litres]	Max. temp with retort [°C]	Max. temp under vacuum [°C]	Max. heat up rate [°C/h]	Dimensions (H x W x D) [mm]			Number of heated zones	Leakage rate [mbar * l/s]	Power [kW]	Weight [kg]
					External overall size	Retort internal size	Uniform ± 5°C and recommended usable volume [mm]				
GPCMA/37	37	310/314/Inconel/Haynes 1000/1050/1100/1150	Optional - at room temperature	-	1990 x 1180 x 1470	205 x 337 x 538	100 x 250 x 300	2	<5x10E-1	17	220
GPCMA/56	56	310/314/Inconel/Haynes 1000/1050/1100/1150	Optional - at room temperature	-	1846 x 1260 x 1725	229 x 400 x 610	150 x 275 x 300	2	<5x10E-1	24	485
GPCMA/117	117	310/314/Inconel/Haynes 1000/1050/1100/1150	Optional - at room temperature	-	1896 x 1360 x 1875	279 x 500 x 840	200 x 400 x 550	2	<5x10E-1	30	608
GPCMA/174	174	310/314/Inconel/Haynes 1000/1050/1100/1150	Optional - at room temperature	-	2045 x 1360 x 1875	428 x 500 x 815	350 x 400 x 550	2	<5x10E-1	36	705
GPCMA/208	208	310/314/Inconel/Haynes 1000/1050/1100/1150	Optional - at room temperature	-	2045 x 1360 x 2025	428 x 500 x 970	350 x 400 x 800	2	<5x10E-1	39	800
GPCMA/245	245	310/314/Inconel/Haynes 1000/1050/1100/1150	Optional - at room temperature	-	2145 x 1460 x 2025	500 x 600 x 815	400 x 500 x 500	2	<5x10E-1	45	950
GLO 5/11-1G	5	1100	1.4841/Inconel 900/1000	600	1500 x 800 x 1400	Ø180 x 350 125 x 125 x 350	100 x 100 x 250	2	<5x10E-3	9	350
GLO 10/11-1G	10	1100	1.4841/Inconel 900/1000	600	1800 x 850 x 1600	Ø250 x 600 170 x 170 x 600	150 x 150 x 400	2	<5x10E-3	14	500
GLO 40/11-1G	40	1100	1.4841/Inconel 900/1000	600	1900 x 1400 x 1800	Ø310 x 600 220 x 220 x 600	200 x 200 x 600	3	<5x10E-3	25	1200
GLO 120/11-1G	120	1100	1.4841/Inconel 700/800	600	2100 x 1800 x 2000	Ø500 x 940 350 x 350 x 940	300 x 300 x 700	3	<5x10E-3	60	2000
GLO 260/11-1G	260	1100	1.4841/Inconel 600/750	600	2300 x 2000 x 2800	Ø640 x 1100 450 x 450 x 1100	400 x 400 x 800	3	<5x10E-3	70	2500
GLO 400/11-1G	400	1100	1.4841/Inconel 600/750	600	2300 x 2000 x 3500	Ø640 x 1500 450 x 450 x 1500	400 x 400 x 1200	4	<5x10E-3	80	3000
GLO 550/11-1G	550	1100	1.4841/Inconel 600/750	550	2300 x 2000 x 4000	Ø640 x 2200 450 x 450 x 2200	400 x 400 x 1900	6	<5x10E-3	90	3300
GLO 600/11-1G	600	1100	1.4841 500	500	2500 x 2300 x 3500	Ø800 x 1800 560 x 560 x 1800	500 x 500 x 1200	6	<5x10E-3	95	3800
GLO 850/11-1G	850	1100	1.4841 500	450	2500 x 2300 x 4000	Ø800 x 2300 560 x 560 x 2300	500 x 500 x 1700	6	<5x10E-3	100	4300
GLO 950/11-1G	950	1000	1.4841 400	450	2600 x 2400 x 3500	Ø1000 x 1700 700 x 700 x 1700	600 x 600 x 1100	6	<5x10E-3	110	4500
GLO 1300/11-1G	1300	1000	1.4841 400	400	2600 x 2400 x 4000	Ø1000 x 2400 700 x 700 x 2400	600 x 600 x 1800	6	<5x10E-3	120	5000

i Please note:
- Maximum continuous operating temperature is 100°C below maximum temperature

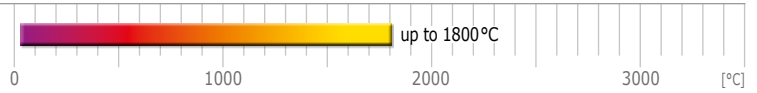

HB – Top Hat Furnaces & HB-BL – Bottom Loading Furnaces

The HB furnace range has an automatically operated vertically moving hood for heat treatment in air as standard option. This design allows samples to be accessed from three sides. The HB can be equipped with CrFeAl heating wires up to 1300 °C or with MoSi₂ heating elements for temperatures up to 1800 °C.

The HB top hat furnaces are available with usable volumes of 80 to 560 litres. The hood moves up and down automated giving access to the hearth for loading and unloading. Alternatively the HB-BL 240 and HB-BL 430 litres model the hood is steady and the hearth moves up and down in a bottom loading way.

For debinding of technical ceramics, preheated air fans can be installed blowing hot air through the hearth into the furnace chamber. For safe combustion of binder gases several options are available, e.g. active propane gas after burner or catalytic oxidiser.



HB 13/240 with optional preheated hot air blowers

Standard features

- 1300 °C, 1600 °C, 1700 °C & 1800 °C maximum operating temperatures
- Carbolite Gero EPC3016P1 controller
- From 80 to 560 litre capacities
- HB = top hat. HB-BL = bottom loading
- FeCrAl wire heating elements for 1300 °C models
- High quality molybdenum disilicide heating elements for higher temperatures
- Energy efficient low thermal mass insulation
- Over-temperature protection
- **NEW** Ethernet communications

Cool down rates for HB furnaces

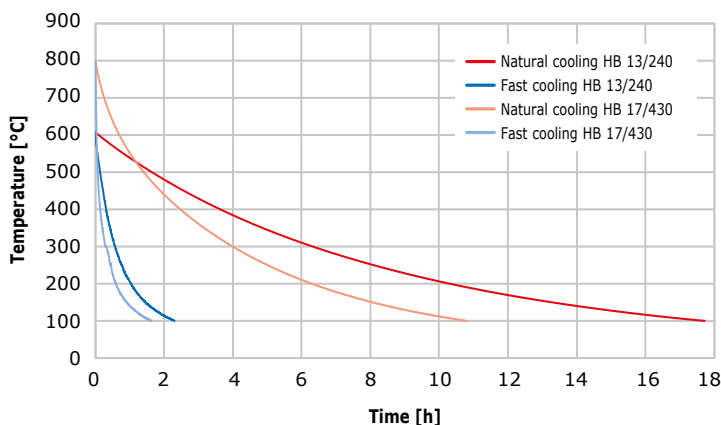

HB 18/80 with optional gas control



Bottom Loader Furnace



HB-BL 17/430 bottom loader with optional PLC and 19 inch touchscreen control and gas outlet connection to optional catalytical after burner

Options (specify these at time of order)

- A range of sophisticated digital controllers, multi-segment programmers and data loggers is available.
- Gas inlet for operation under modified atmosphere (furnace is not gas tight)
- Air blower + pre-heater up to 600°C
- Active propane gas after burner or catalytic oxidiser for safe combustion of debinding applications
- Reinforced base plate for a surface load of 500 kg/m² instead of 250 kg/m²
- Bottom heater for improved temperature uniformity.
Note: This option cannot be combined with the reinforced base

Hood Furnace

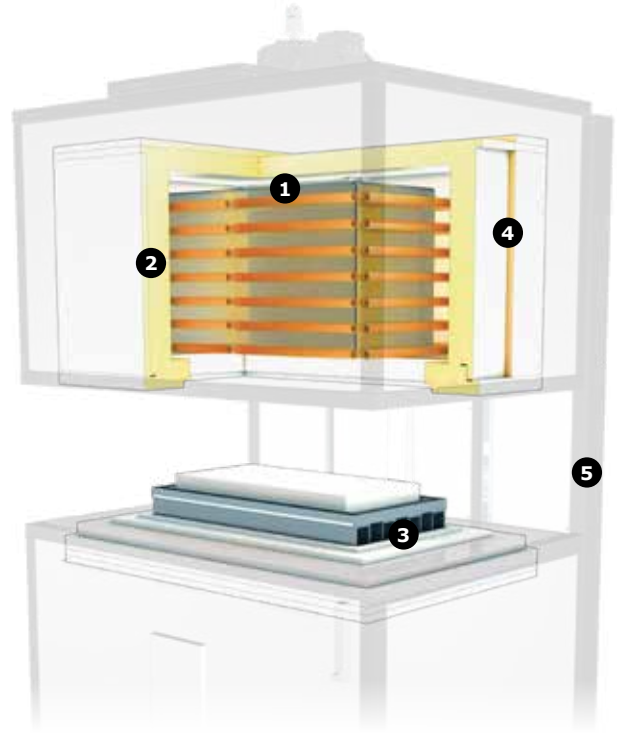

View inside

- | | |
|---|---|
| 1) FeCrAl heating elements up to 1300 °C | 4) Top hat: movable hood; Bottom loading: steady hood |
| 2) Low thermal mass insulation | 5) Frame |
| 3) Top hat: steady hearth; Bottom loading: movable hearth | |

Technical data

CGN Model	Max. temp. [°C]	Uniformity between 800°C and T _{max} [°C] (DIN 17052)	Max. heat-up rate [°C/min]	Cooling time [h]	Dimensions: Usable chamber H x W x D [mm]	Dimensions: External H x W x D [mm]	Volume [l]	Max. power [kW]
Top hat furnaces (with steady hearth)								
HB___/80	1300, 1600, 1700, 1800	±5	5, 10, 10, 10	12, 14, 14, 14	500 x 400 x 400	2200 x 1200 x 1200	80	18, 45, 50, 60
HB___/160	1300, 1600, 1700, 1800	±5	5, 10, 10, 10	14, 14, 14, 14	500 x 800 x 400	2200 x 1800 x 1200	160	30, 80, 85, 90
HB___/240	1300, 1600, 1700, 1800	-	-	14	500 x 1200 x 400	2200 x 2200 x 1200	240	63, 65, 69, 75
HB___/430	1300, 1600, 1700, 1800	-	-	-	600 x 1200 x 600	2500 x 2200 x 1500	430	-
HB___/560	1300, 1600, 1700, 1800	-	-	-	780 x 1200 x 600	2700 x 2200 x 1400	560	-
Bottom loader furnaces (with moving hearth)								
HB-BL___/240	1300, 1600, 1700, 1800	-	-	14	500 x 1200 x 400	3600 x 2200 x 2500	240	63, 65, 69, 75
HB-BL___/430	1300, 1600, 1700, 1800	-	-	-	600 x 1200 x 600	3700 x 2200 x 2700	430	-

i Please note:
- Maximum continuous operating temperature is 100°C below maximum temperature

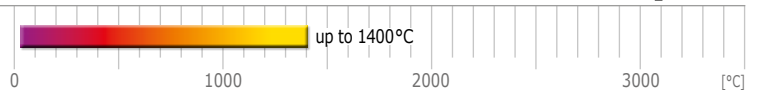

LCF – Large Chamber Furnaces

The robust construction of the LCF large chamber furnaces makes them ideal for applications such as the heat treatment of steels and alloy, ceramics sintering and aerospace heat treatment.

The LCF range is often customised in order to precisely meet the user's requirements. This range also provides a foundation upon which a wide range of custom modifications can be added. Typical examples include the more sophisticated control systems and data recording that is required for applications such as AMS2750F heat treatment under Nadcap. Solutions are available to handle heavier loads or assist in loading and unloading the furnace, or larger chamber sizes than are offered in the standard range.

Standard features

- 1200 °C & 1400 °C maximum temperatures
- Programmable EPC3016P1 controller
- Over-temperature protection
- Excellent temperature uniformity and control
- Robust construction using hollow steel section & zinc coated steel sheet
- Double skin construction ensures safe outer case temperature
- Manually operated vertically opening door keeps the hot face away from the operator
- Low thermal mass insulation for high energy efficiency
- Hard wearing silicon carbide tiled hearth
- 1200 °C range heated by heavy gauge wire elements in roof and below the hearth
- 1400 °C range heated by silicon carbide elements in roof and below the hearth
- Safety door interlock isolates power from the elements whenever the door is opened
- **NEW** Ethernet communications



Customised
3-zone LCF 12/560

Options (specify these at time of order)

- A range of sophisticated digital controllers, multisegment programmers and data loggers with digital communication options is available (see page 100)
- Pneumatically or electrically operated doors
- A range of retorts can be supplied for using modified atmospheres up to 1000 °C
- Remote control module
- Designs for compliance with AMS2750F (Nadcap) and other industry standards

Technical data

CGH Model	Max. temp. [°C]	Max. continuous operating temperature [°C]	Dimensions: Usable chamber H x W x D [mm]	Dimensions: External H x W x D [mm]	Volume [litres]	Max. power [W]	Thermocouple type
LCF 12/202	1200	1150	300 x 600 x 1120	2360 x 1280 x 1640	202	24000	R
LCF 12/405	1200	1150	450 x 750 x 1200	2560 x 1440 x 1750	405	35000	R
LCF 12/560	1200	1150	500 x 750 x 1500	2700 x 1500 x 2300	560	45000	R
LCF 12/675	1200	1150	500 x 750 x 1800	2700 x 1500 x 2600	675	60000	R
LCF 12/720	1200	1150	600 x 1000 x 1200	2950 x 1575 x 1810	720	60000	R
LCF 14/125	1400	1400	250 x 500 x 1000	2310 x 1340 x 1650	125	30000	R
LCF 14/350	1400	1400	400 x 760 x 1130	2545 x 1549 x 1800	350	48000	R
LCF 14/480	1400	1400	500 x 800 x 1200	2560 x 1650 x 1900	480	60000	R
LCF 14/725	1400	1400	500 x 720 x 1790	2620 x 1480 x 2470	725	60000	R

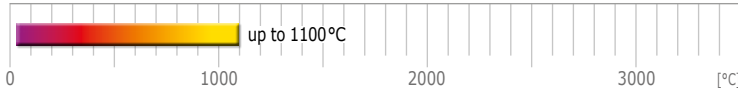

SBCF – Static or Bogie Hearth Chamber Furnaces

The robust construction of the SBCF large chamber furnace makes it ideal for applications such as the heat treatment of steels and alloys, ceramics sintering and aerospace heat treatment.

The SBCF is an industrial scale chamber furnace with an internal working volume that is cubic in shape and is available in three sizes. The furnace has a side hinged door and a fixed hearth. As an option the hearth can be fitted to a bogie so it can be pulled out of the furnace on a track system.

For applications demanding the best uniformity possible over a wide temperature range, such as AMS2750F, an optional vertical air circulation fan is available making possible a temperature uniformity of $\pm 5^\circ\text{C}$ from 400°C to 1000°C .



SBCF 11/1700

Standard features

- 1100°C maximum operating temperature
- 3-zone control fitted with 1 x programmable EPC3008P1 and 2 x EPC3016 slaves with retransmission of setpoint
- Over-temperature protection
- Furnace can meet the requirements of AMS2750F
- Under hearth heating and free radiating coiled wire elements on four sides
- Excellent temperature uniformity and control
- Robust double skin construction ensures safe outer case temperature
- Hard wearing silicon carbide tiled hearth

Heat treatment run in SBCF-3/11/500

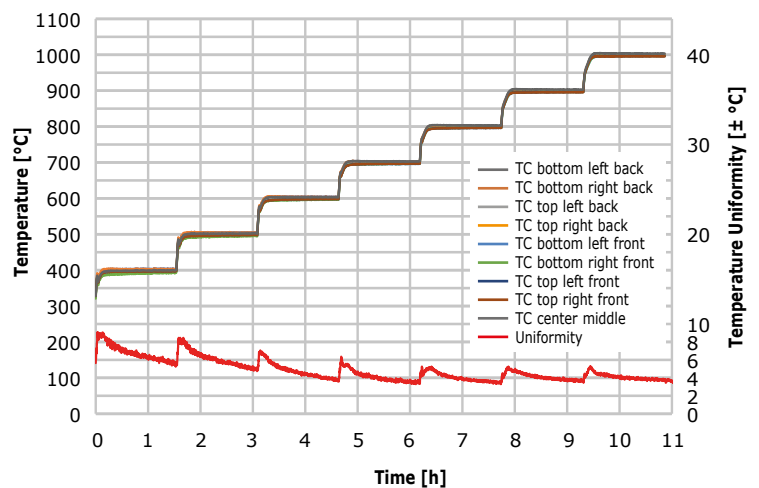

Options (specify these at time of order)

- Temperature interlocked door
- Bogie hearth
- Vertical air circulation fan
- Available with various instrumentation and data acquisition options

Technical data

CGH Model	Zones	Max. temp. [°C]	Dimensions: External H (with fan / without fan) x W x D [mm]	Volume [litres]	Chamber size H x W x D [mm]	Uniform volume H x W x D [mm]	Temperature uniformity [°C]	Max. power [W]
3-Zone Static or Bogie Hearth Chamber Furnace								
SBCF-3/11/500	3	1100	2353/2130 x 1710 x 1354	512	800 x 800 x 800	600 x 600 x 600	± 5	54000
SBCF-3/11/1700	3	1100	2753/2530 x 2110 x 1754	1728	1200 x 1200 x 1200	1000 x 1000 x 1000	± 5	96000
SBCF-3/11/3300	3	1100	3053/2830 x 2410 x 2054	3375	1500 x 1500 x 1500	1300 x 1300 x 1300	± 5	144000

i Please note:
- Maximum continuous operating temperature is 100°C below maximum temperature

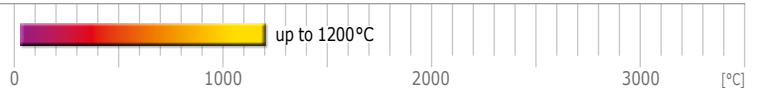

Ashing Furnaces

One of the most common applications for laboratory furnaces is to heat combustible samples in order to analyse the ash residue. As there is no single solution for all requirements, Carbolite Gero offers a range of furnaces with characteristics tailored to ashing and burn-off applications.

There are several important factors to consider, which will help to identify the correct furnace for successful ashing:

- Does the ashing process have to conform to a given test method, e.g. ISO/ASTM or other published standard?
- Does the ashing / burn-off process generate aggressive fumes which could damage the furnace or be hazardous?
- Will the furnace provide an adequate airflow to fully combust the sample?
- How large are the samples which must be ashed in order to provide a sufficiently large residue of ash for analysis?
- How intensive is the work cycle and how many samples must be processed?
- Would contamination of the ash with traces of alumina or silica (from conventional insulation materials) be detrimental?

Guide to ashing furnace selection

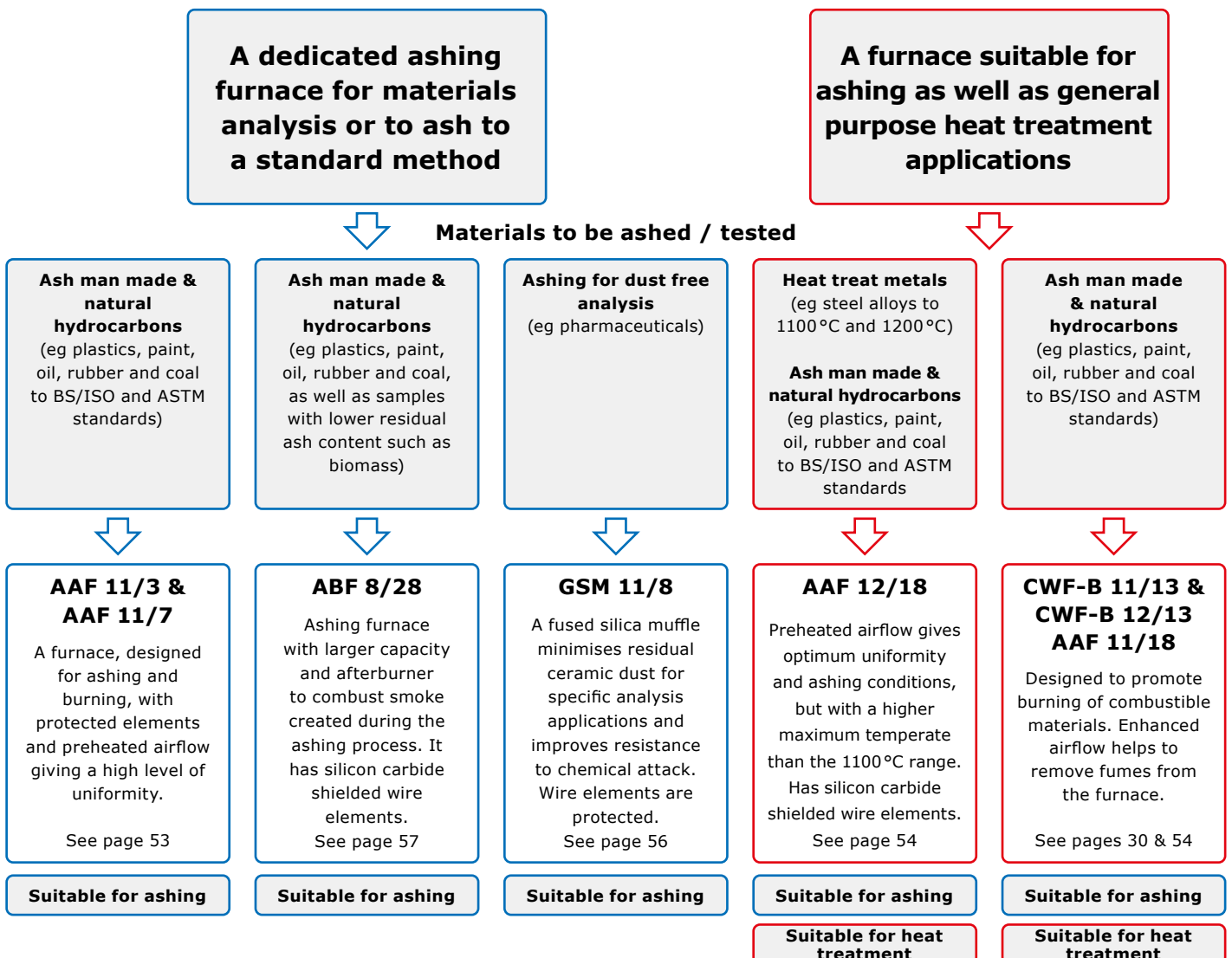

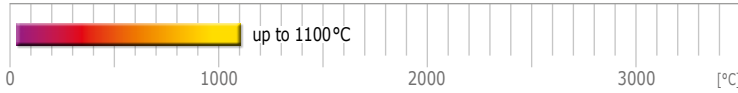

AAF – Standard Ashing Furnaces

The range of AAF ashing furnaces is designed specifically to provide optimum ashing conditions to ensure complete combustion of the sample.

The AAF 11/3 & AAF 11/7 ashing furnaces provide a continuous flow of preheated air through the chamber, and are designed to comply with ISO 1171:2010, ASTM D3174-04: 2010 and ASTM D4422.

Standard features

- 1100°C maximum operating temperature
- Carbolite Gero 301 single ramp to setpoint & process timer
- Large floor area allows for large number of samples
- Ideal for ashing foods, plastics, coal & other hydrocarbon materials
- Designed to comply with ISO 1171:2010, ASTM D3174-04: 2010 and ASTM D4422
- Wire elements are protected from chemical & mechanical damage by a hard wearing alumina based liner
- 4 sided heating (2 sides, roof & hearth)
- Air inlet & tall chimney give airflow of 4 to 5 changes per minute
- Low chamber height holds airflow close to samples for optimum combustion
- Powerful elements with graded winding compensate for heat loss due to high airflow
- Preheating of air before it enters the chamber gives excellent uniformity
- Sample tray and loading handle



AAF 11/3 and AAF 11/7

AAF 11/3 and AAF 11/7:

Airflow

- 1) A tall 50 mm diameter chimney (AAF 11/7), or 35 mm on AAF 11/3, pulls the air through the chamber
- 2) Preheated air enters the chamber after circulating around the outside of the chamber
- 3) Air inlet

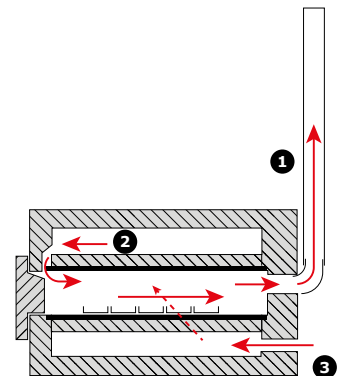

Options (specify these at time of order)

- 2 phase electrical supply for AAF 11/7
- A range of sophisticated digital controllers, multisegment programmers and data loggers with digital communication options is available (see page 100)
- Over-temperature protection (recommended to protect valuable contents & for unattended operation)

Accessories

- 1) Tray, dimensions inside (WxD):
AAF 11/3: 133x210 mm
- 2) Tray, dimensions inside (WxD):
AAF 11/7: 163x330 mm
- 3) Loading handle

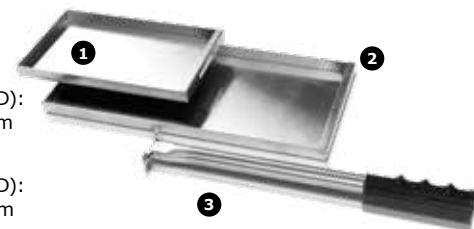

Catalytic converter option

The thermal catalytic oxidiser option is suitable for applications where the exhaust gases are the result of organic reactions. Preheated air flows around and through the AAF chamber fueling combustion of the sample. The resulting gases or fumes are carried out of the chamber into the catalytic converter. Additional fresh air is drawn into the catalytic converter over an integral heater where the catalyst causes a chemical reaction to reduce the amount of fumes and unburnt volatiles.



AAF furnace + catalytic converter

- External dimensions:
AAF 11/3: 740 x 375 x 670 mm
AAF 11/32: 1600 x 690 x 900 mm
- External dimensions with door open:
AAF 11/3: 800 x 375 x 670 mm
AAF 11/32: 1600 x 690 x 900 mm
- Catalytic converter power supply requirements:
AAF 11/3: 600 W
AAF 11/32: 2500 W

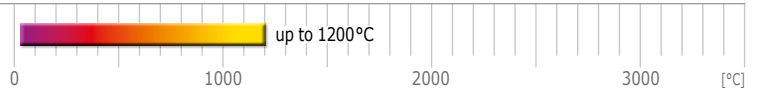

AAF – Standard Ashing Furnaces

The range of AAF ashing furnaces is designed specifically to provide optimum ashing conditions to ensure complete combustion of the sample.

For those laboratories where ashing is interspersed with other heat treatment work the AAF 12/18 provides all of the advantages of the AAF design, but with a higher maximum operating temperature of 1200 °C.

Standard features

- 1100 °C & 1200 °C maximum operating temperatures
- Carbolite Gero 301 single ramp to setpoint & process timer
- Two tier rack system doubling the sample capacity with sample trays and loading handle allows for large number of samples
- Ideal for ashing foods, plastics, coal & other hydrocarbon materials
- Preheating of air before it enters the chamber
- Protection of the elements from carbon build-up or corrosive atmosphere, using silicon carbide tiles
- 2 sided heating



AAF 11/18

AAF 11/18, AAF 12/18,
AAF 11/32, AAF 12/32:

Airflow

- 1) Air inlet – air is preheated before entering the chamber
- 2) Plenum – a small amount of air flows between the heating elements and SiC side walls, to clear any fumes away from the elements. This combines with the chamber exhaust in the plenum.
- 3) Chimney
- 4) Two tier rack and trays

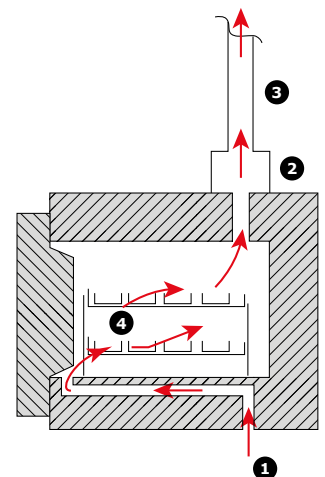

Accessories

- 1) AAF 11/18 & AAF 12/18 two tier rack system
- 2) Perforated tray, dimensions inside (WxD):
AAF ___/18: 163x330 mm
AAF ___/32: 247x387 mm
- 3) Loading handle

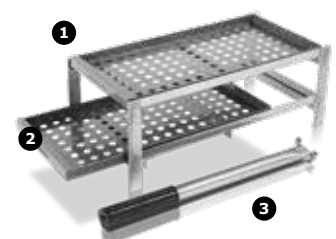

Options (specify these at time of order)

- A range of sophisticated digital controllers, multisegment programmers and data loggers with digital communication options is available (see page 100)
- Over-temperature protection (recommended to protect valuable contents & for unattended operation)

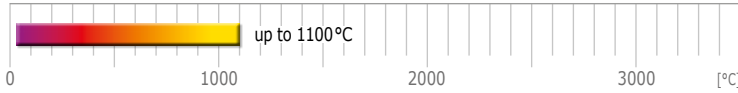

AAF-BAL - Ashing Furnace with Balance

The AAF-BAL furnace incorporates an integral balance. It can be used for loss on ignition applications where weight change of the sample must be monitored during the heating process.

The AAF-BAL ashing furnace is fitted with an integral balance and can be used for loss on ignition (LOI) applications. Weight change of the sample is monitored during the heating process and this is required, for example, in the determination of organic matter content in materials such as sediment, sludge, soil and waste. Inorganic materials such as cement, lime, calcinated bauxite and refractories can also be tested.

Options (specify these at time of order)

- Advanced version for EPC3008P10 to data-log both weight and temperature. It is also necessary to select the following options: EPC3008P10 instrument (which includes Ethernet communication). Data logging is done via iTools software which must be purchased separately
- Advanced version for nanodac to data-log both weight and temperature. It is also necessary to select the following options: nanodac instrument. Data logging is done in the nanodac and can be downloaded into the 'Review Lite' software which is included with the nanodac. Data can be archived onto a USB flash drive or via Ethernet to a networked server.
- Over-temperature protection (recommended to protect valuable contents & for unattended operation)



AAF-BAL 11/17

Standard features

- 3216CC controller with single ramp to setpoint and process timer
- Protection of the elements from carbon build-up or corrosive atmosphere, using silicon carbide tiles
- 2 sided heating
- Balance runs independently of the furnace control system
- Maximum capacity of balance is 3 kg with a resolution of 0.01 g (other capacities available)

Technical data

Model	Max. temp. [°C]	Heat-up time [mins]	Max. continuous operating temp. [°C]	Dimensions: Usable chamber H x W x D [mm]	Dimensions: External H x W x D [mm]	Dimensions: External with door open H x W x D [mm]	Dimensions: Height to top chimney [mm]	Volume [litres]	Max. power [W]	Holding power [W]	Thermo-couple type	Weight [kg]
CGH												
AAF 11/3	1100	155	1000	90 x 150 x 250	585 x 375 x 485	800 x 375 x 485	780	3	2100	1270	K	22
AAF 11/7	1100	155	1000	90 x 170 x 455	650 x 430 x 740	905 x 430 x 740	1060	7	4000	2624	K	63
AAF 11/18	1100	70	1000	235 x 196 x 400	705 x 505 x 675	990 x 505 x 675	990	18	7080	3500	K	70
AAF 11/32	1100	70	1000	250 x 280 x 450	820 x 690 x 730	1050 x 690 x 730	1200	32	9000	-	K	100
AAF 12/18	1200	70	1100	235 x 196 x 400	705 x 505 x 675	990 x 505 x 675	990	18	7080	3500	R	70
AAF 12/32	1200	95	1100	250 x 280 x 450	820 x 690 x 730	1050 x 690 x 730	1200	32	9000	-	R	100
AAF-BAL 11/17	1100	-	1000	215 x 196 x 400	705 x 505 x 675 (400 x 170 x 500)*	990 x 505 x 675 (400 x 170 x 500)*	990	17	7080	3500	K	70

i Please note:

- Holding power is measured at 500°C
- Heat up time is measured to 100°C below max, using an empty chamber

- Maximum power and heat up time based on a 240 V supply
- *Dimensions of control box

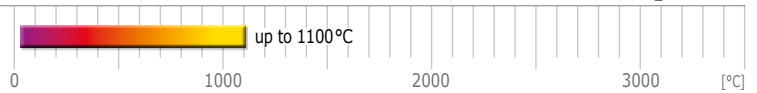

GSM – Specialist Ashing Furnace

Some analysis techniques may be affected by alumina or silica dust (Al_2O_3 and SiO_2) – the materials normally used to construct furnace chambers.

To avoid this the GSM furnace chamber is constructed from a fused quartz material.

This design also offers superior containment of aggressive and corrosive vapours such as sulphuric, nitric and hydrochloric acids by keeping them away from the heating elements. Additionally if an optional gas inlet is specified, the enclosed design minimises gas leakages from the chamber.

Standard features

- 1100°C maximum operating temperature
- Carbolite Gero 301 single ramp to setpoint & process timer
- Fused quartz furnace chamber, ideal for analyses where Al_2O_3 and SiO_2 could contaminate test results
- Chamber lining offers superior containment of corrosive & aggressive vapours such as H_2SO_4 , HNO_3 , HCl
- 4 sided heating (2 sides, roof & hearth)
- Moulded ceramic fibre door plug



GSM 11/8

Options (specify these at time of order)

- A range of sophisticated digital controllers, multisegment programmers and data loggers with digital communication options is available (see page 100)
- Over-temperature protection (recommended to protect valuable contents and for unattended operation)
- Gas inlet for modified atmospheres (the fused quartz liner provides improved containment)
- Sample trays & racks

Airflow in GSM

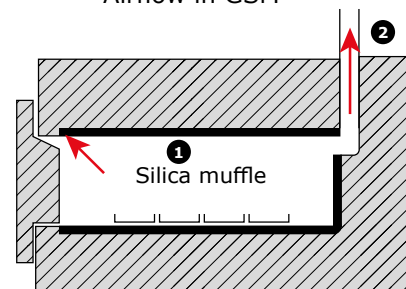

- 1) Quartz silica muffle protects the heating elements
- 2) Chimney vents fumes from the chamber

Technical data

Model	Max. temp. [°C]	Heat-up time [mins]	Max. continuous operating temperature [°C]	Dimensions: Usable chamber H x W x D [mm]	Dimensions: External H x W x D [mm]	Dimensions: External with door open H x W x D [mm]	Dimensions: Height to top chimney [mm]	Volume [litres]	Max. power [W]	Holding power [W]	Thermocouple type	Weight [kg]
GSM 11/8	1100	70	1000	120 x 175 x 345	655 x 435 x 750	895 x 435 x 750	1060	8	2950	1700	K	57

i Please note:

- Heat up time is measured to 100°C below max, using an empty chamber
- Holding power is measured at continuous operating temperature

- Maximum power and heat up time based on a 240 V supply
- The maximum depth to accommodate the door opening arc is 810 mm



ABF – Afterburner Ashing Furnace

The ABF afterburner ashing furnace is particularly suitable for ashing larger samples or materials such as biomass, which are likely to generate substantial amounts of smoke.

The furnace comprises a large main combustion chamber equipped as standard with a two tier set of sample baskets. The exhaust from the main chamber passes through a high temperature afterburner designed to further process fumes and smoke.

Standard features

- 800 °C maximum operating temperature – ashing chamber
- EPC3016P1 programmable controller
- 28 litre chamber volume
- Afterburner rated for up to 40 g carbon per ashing load
- Two tier baskets with loading tray and handle
- Independent control of afterburner temperature up to 950 °C
- Silicon carbide shielded wire wound elements
- Supplied with 3-phase supply as standard
- **NEW** Ethernet communications



ABF 8/28

Airflow in ABF 8/28

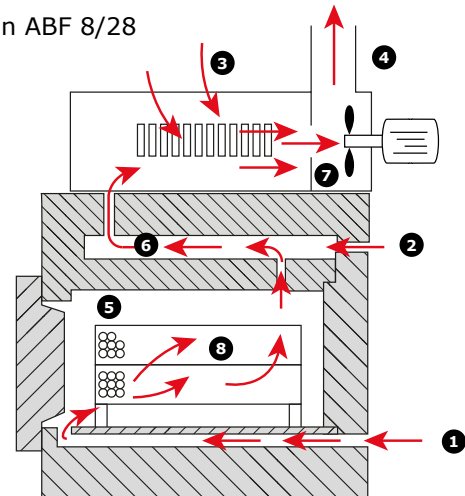

- | | |
|---|--------------------------------------|
| 1) Air inlet – air is preheated before entering the chamber | 4) Chimney |
| 2) Air inlet into afterburner to ensure complete combustion | 5) Furnace chamber |
| 3) Air inlet into plenum to cool the gases before entering the extraction fan | 6) Afterburner |
| | 7) Extraction fan |
| | 8) Two tier perforated basket system |

Options (specify these at time of order)

- A range of sophisticated digital controllers, multisegment programmers and data loggers with digital communication options is available (see page 100)
- Over-temperature protection (recommended to protect valuable contents & for unattended operation)
- Optional floor stand

Technical data

CGH Model	Max. temp. [°C]	Max. continuous operating temperature [°C]	Dimensions: Usable chamber H x W x D [mm]	Dimensions: External H x W x D [mm]	Dimensions: Height to top chimney [mm]	Volume [litres]	Max. power [W]	Holding power [W]	Thermocouple type	Weight [kg]
ABF 8/28	800	700	210 x 290 x 445	980 x 600 x 750 (Bench-top or optional stand)	1150	28	8000	3828	K	120

- i** Please note:
- Holding power is measured at 500 °C
 - Heat up time is measured to 100 °C below max, using an empty chamber
 - External dimensions with door closed



ABA – Asphalt Binder Analyser

The ABA 7/35B is designed to measure the asphalt binder content of hot mix asphalt (HMA) using loss on ignition, in accordance with AASHTO T 308-10, ASTM D6307-19 & BSEN 12697-39:2020.

The integral microprocessor controlled weighing and calculation system is configurable to allow variations to the standard test method. Test result reports are available in both printed and software format. The high temperature afterburner minimises the production of noxious waste fumes. Supplied complete with 2 sets of sample baskets.



ABA 7/35B
(mounted on optional
floor stand)

Standard features

- 750°C maximum operating temperature
- Designed to measure asphalt binder content by loss on ignition
- Avoids the health, environmental & waste management issues & expense associated with the older solvent extraction methods
- Reduced emissions due to high temperature afterburner
- Controlled via a multi-lingual touchscreen interface
- Supplied as standard with English, Spanish, French, Chinese, Italian & Russian language display. Other languages are available to order
- Automatic calculation of final sample weight & binder % result
- Adjustable aggregate correction factor
- Precise weight measurements displayed to 0.1 g resolution
- Has the capacity for large sample sizes for more accurate results (maximum sample weight 4.5 kg)
- Average test times from 20 mins for 6 mm aggregates, to 45 mins for 40 mm aggregates
- Permanent (dot-matrix) printed reports
- USB data output compatible with most spread sheets
- Easy naming, storage & recall of recipes that can be transferred between ABA 7/35B units
- Simplified menu structure with secure 'Supervisor' & 'Operator' settings

- 1) LCD touchscreen control
- 2) Integral fan assisted high-temperature afterburner greatly reduces emissions
- 3) Safety circuits warning lamps
- 4) Rapid heating main chamber with robust 1 mm Ø wire elements
- 5) Integral balance measures loss on ignition to 0.1 g resolution
- 6) Automatic capture of initial weight data is possible from an external balance by RS232 cable
- 7) Optional flat pack floor stand
- 8) Control panel with:
 - Instrument on/off switch
 - Printer on/off switch
 - Safety circuits test switch
 - Afterburner heating lamp
 - Main chamber heater lamps
 - USB data output
- 9) Printer

Technical data

CGH Model	Max. temperature [°C]	Dimensions: Internal H x W x D [mm]	Dimensions: External H x W x D [mm]	Max. power [W]	Thermocouple type	Weight [kg]
ABA 7/35B	750	220 x 350 x 450	980 x 600 x 775 (Bench-top or optional stand)	8000	K	120

i Please note:

- The oven is rated at 8 kW for operation on 208/240 V, 50/60 Hz, three or single phase. Please state mains supply when ordering

- The oven holding power is approximately 3 kW



Safe solvent-free binder calculation

Asphalt binder content affects hot mix asphalt (HMA) mixture performance in the areas of strength, durability, fatigue life, ravelling, rutting and moisture damage. Hot mix asphalt (HMA) that has too much asphalt binder may experience problems such as, reduced skid resistance and reduced resistance to permanent deformation, eg rutting. HMA that has too little asphalt binder may experience reduced fatigue resistance and problems with stripping.

Horizontal & Vertical Tube Furnaces up to 1800°C

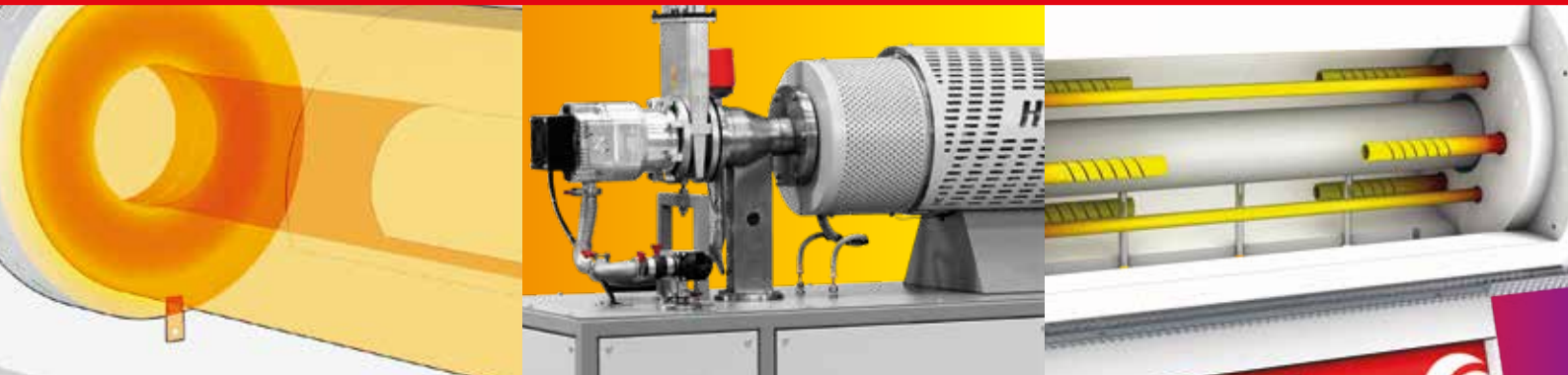

Tube Furnaces	Models	Page
Tube Furnaces Selection Guide		62
Universal Tube Furnaces & Split Tube Furnaces	TF1, TF3, FHA, FHC, HTRH, HTRV TS1, TS3, FST, FZS, HTRV-A, TSO, TSR	66
Gradient Tube Furnaces	TG2, TG3	86
Special Application Furnaces		92

With over 8 decades experience manufacturing universal and split-tube furnaces, Carbolite Gero is a global leader in the demanding area of temperature uniformity. A tube furnace is often selected as the most economical method of heating a small sample. Our latest power efficient tube furnace design significantly reduces the overall power consumption used in every cycle helping to improve your initial Return on Investment and ensuring you minimise your electricity costs.

Tube furnaces enable rapid temperature changes on the sample. They are available with single, three zone or gradient heating capabilities and can be configured with an inert atmosphere or a vacuum. Whatever your specific requirement we have a range of solutions that are highly configurable.

Carbolite Gero's design features optimised uniform zone

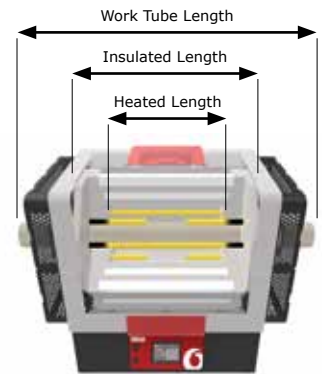

All Carbolite Gero tube furnaces have heating elements optimised for uniform temperature distribution.

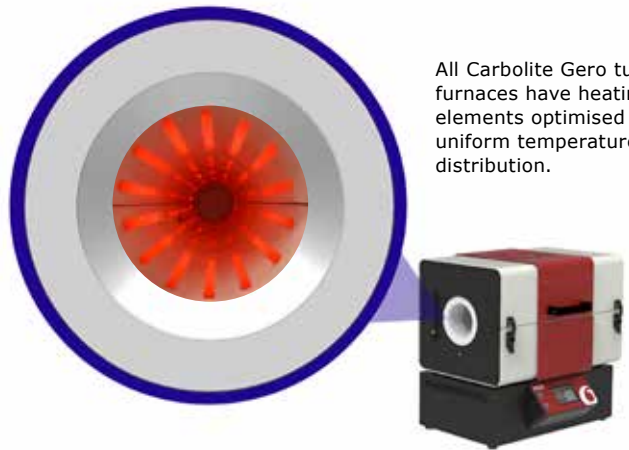

The Selection of a Tube Furnace should take into Account the following Factors:

What temperature?

- It is recommended to allow at least 100 °C extra heating range above the desired working temperature
- Standard models are available with maximum operating temperatures from 1100 °C to 1800 °C

Single or 3-zone?

- Tube furnaces provide a high level of uniformity which may be required for applications that require a specific temperature uniformity (see image top right showing typical optimised uniform length).
- The length of the central uniform zone can be further increased by adding heated zones at the ends in the form of a 3-zone furnace design
- For temperature gradients see page 86

Size & work tubes?

- An accessory work tube is essential for tube furnaces
- To ensure the material properties are appropriate for the users application, accessory work tubes are available in a range of materials (see page 106)
- See the 'work tube package' section pages 107 for details of the available work tube package.

Modified atmosphere or vacuum?

- Tube furnaces are ideal when the sample must be heated in an inert atmosphere or a vacuum
- Work tube packages for use with gas atmosphere and vacuum are available (pages 107)
- A choice of rotary vane or turbomolecular vacuum pump packages is available (see page 112)

Temperature Uniformity Comparison

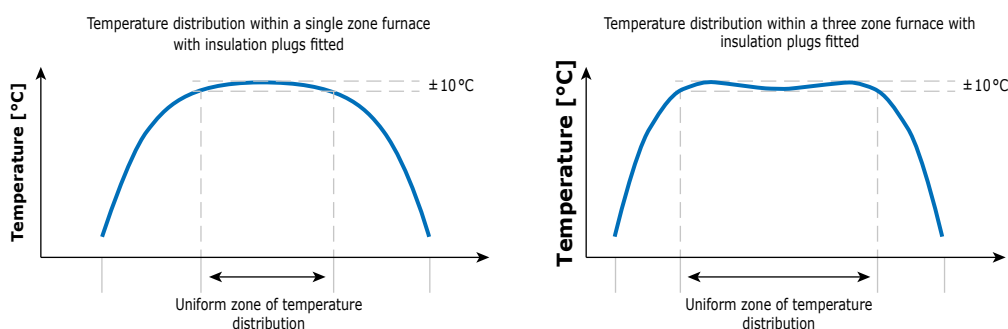

Mounting Configurations

The Carbolite Gero TF, TS & TG tube furnaces are supplied in a horizontal configuration as standard.

The Carbolite Gero FHA, FHC, HTRH, HTRH-3, FST, FZS tube furnaces are supplied in a horizontal configuration as standard. The HTRH and HTRH-3 furnaces can not be tilted.

The Carbolite Gero HTRV and HTRV-A tube furnaces are supplied in a vertical configuration as standard and can not be tilted.

Furnace body on top of control box

The following models have the furnace body mounted on top of the control box:

- TF mini;
- TF & TS small;
- TF & TS medium up to and including 600 mm heated length;
- TF 1600°C;
- TG small and medium.

The furnace body can be easily dismantled from the control box. The 2 m long interconnection cables that connect the furnace body to the control box allow the furnace control box to be positioned remotely from the furnace body. The interconnecting cables of the Ø 125 & 200 mm models can be easily unplugged.



TS small. Furnace body can be dismantled from the control box

Furnace body and separate control box

The following models have a separate control box:

- TF & TS medium 800 mm heated length and above;
- TS large.
- FHA, FHC, FST & FZS
- HTRH & HTRH-3
- HTRV & HTRV-A



FHA 13/80/500 with optional CC-T1 controller and optional inert gas package

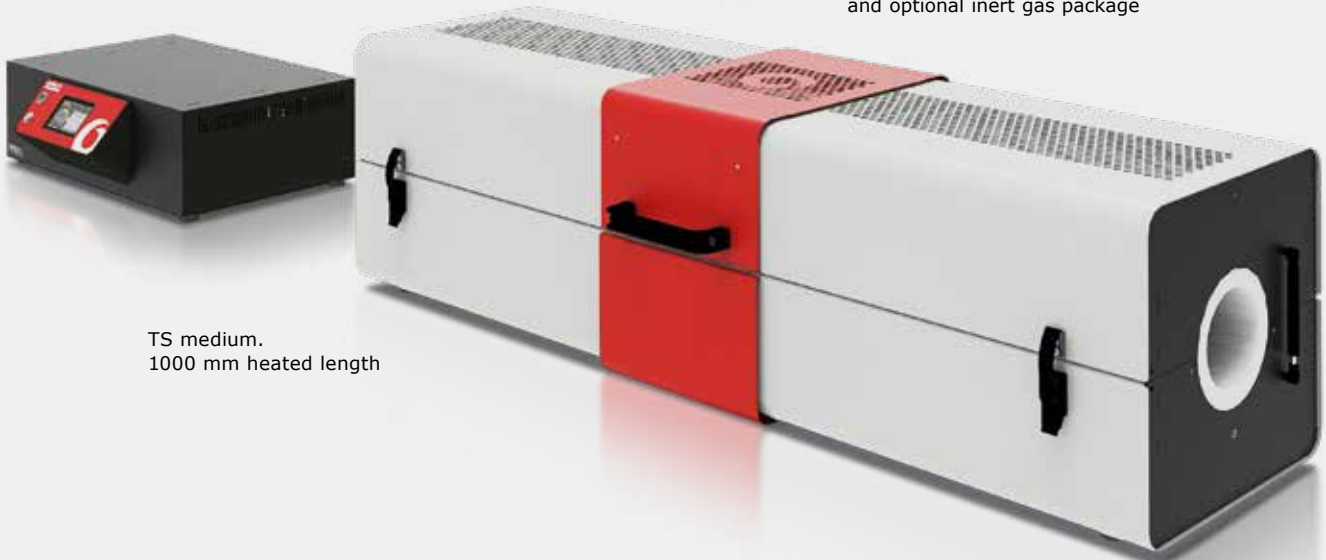

TS medium.
1000 mm heated length

Vertical Packages

Optional 'vertical packages' can be ordered to mount the furnace body in a vertical orientation for the TF, TS & TG furnaces.

L-stands available for vertical use for FHA, FHC, FST, FZS tube furnaces.

Stands available for HTRV and HTRV-A tube furnaces as sole option and are part of inert gas packages with long work tube.

L-stand for F-range tube furnaces



FHA, FHC, FST, FZS range with L-stand

Vertical stand for HTRV & HTRV-A tube furnaces



HTRV range with stand and optional inert gas package

Interconnect cables

TF, TS & TG

The interconnection cables are 2 m long and allow the furnace control box to be positioned remotely from the furnace body. The interconnecting cables of the Ø 125 & 200 mm models can be easily unplugged. Optional 4 m extension leads are available to give a total of 6 m interconnection cable.

FHA, FHC, FST & FZS

HTRH & HTRH-3

HTRV & HTRV-A

The interconnection cables are 3 m long and can be easily unplugged. Optional 6 m long interconnection cables are available.



Vertical Packages – TF, TS & TG

Vertical Tube Support Package

Three Vertical packages are available for the TF, TS & TG tube furnaces.

These are:

- Vertical tube support package
- Vertical stand + Vertical tube support package
- Vertical mounting bracket + Vertical tube support package

Vertical Tube Support Package

Vertical tube support packages include:

- A work tube guide bracket. This fixes to the top of the tube body and holds the work tube in place in split tube furnaces.
- A lower work tube support clamp arrangement that supports the work tube towards the bottom. The clamp fixes to the tube body.



The vertical tube support package for TF, TS & TG without stand or mounting bracket is also available

Please enquire for:

TF & TS 1200°C Medium 800 and longer, TS 1200°C large and TF 1600°C medium.

Vertical stand & vertical tube support package

Vertical stand design for TF mini tube furnace.



TF1 11/32/150

Vertical stand design for TF, TS & TG 1200°C small tube furnaces



TS1 12/60/150

Vertical stand design for TF, TS & TG 1200°C medium and large tube furnace, and TF 1600°C tube furnaces.



TS1 12/125/600

Vertical mounting bracket & vertical tube support package

Vertical mounting bracket design for TF mini tube furnace



Vertical mounting bracket design for TF, TS & TG 1200°C small tube furnaces



Vertical mounting bracket design for TF, TS & TG 1200°C 400 & 600 long medium tube furnace, and TF 1600°C small tube furnaces.





TF1, TF3 Tube Furnaces

With maximum temperatures ranging from 1100°C and 1200°C, the TF tube furnace range incorporates high-quality heating elements and innovative thermal insulation design to achieve first class performance delivering both reduced case temperatures and power consumption.



TF1 11/32/150 with CC-T1 temperature programmer



TF1 11/32/150 with vertical package option

Standard features

- 1100°C & 1200°C maximum operating temperatures
- Programmable temperature controller with 24 segments.
 - TF1 fitted with Carbolite Gero EPC3016P1
 - TF3 fitted with Carbolite Gero CC-T1
- Ethernet Communications
- TF1 (1-zone) Heated length range from 150 to 1200 mm
- TF3 (3-zone) Heated length range from 450 to 1200 mm
- Accepts work tubes with outer diameters from 32 mm up to 125 mm
- Wire elements in high quality vacuum formed insulation ensure fast heat up, excellent temperature uniformity and short cool down times
- Horizontal configuration mounted on control module for heated lengths up to 600 mm
- Furnace body detachable from the control box to allow use of optional mounting arrangements (see pages 63–64)
- Horizontal configuration have a separate control module for heated lengths of 800 mm and above
- Control module with 2 metre cable to furnace. Furnaces with 125 mm Ø include plug and socket.

The extensive range features three main case sizes, mini, small, and medium, with multiple heated lengths available. Standard models can be configured to function with a single heated zone (TF1) or three heated zones (TF3) to extend the uniform heated length. Each heated zone of the TF3 benefits from its own dedicated controller and thermocouple.

A slide-in accessory work tube is required to protect the heating elements and support the work piece. The TF range can accommodate work tubes with outside diameters of 32 mm to 125 mm.

The variety of available work tubes and the use of tube adapters allow a single furnace to accommodate a variety of tube diameters. The work tubes themselves can easily be exchanged to meet the different physical or chemical requirements of a process.

Optional work tube packages enable users to equip the TF for operation under vacuum or modified atmosphere; for such applications, an extended work tube is required. Information can be found on pages 107.

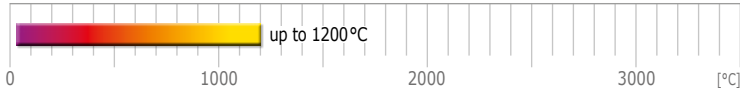

TF1 12/125/1000 with CC-T1 temperature programmer

NEW



- Low power consumption
- Optimised heating element positions
- Flexible mounting options
- Ethernet fitted as standard
- Temperature programmer as standard

Options (specify these at time of order)

- A range of sophisticated digital controllers, multi-segment programmers and data loggers with digital communication options is available (see page 100)
- Over-temperature protection (recommended to protect valuable contents & for unattended operation)
- A range of additional work tubes (page 106), end seals (page 110) and work tube packages (page 107) is available for use with modified atmosphere and/or vacuum
- Vacuum packages with a choice of rotary vane pump or turbomolecular pump are available (page 112)
- Wide choice of tube diameters and materials is available. See page 106 for tube materials
- Insulation plugs and radiation shields to prevent heat loss and improve uniformity
- Vertical mounting stand for the furnace body including bracket for mounting the furnace body to customer's equipment
- 4 m long extension cable to give a total 6 m length of cable between furnace body and control box
- Gas packages with manual valve (page 113)
- Gas packages with electrically operated valve for up to 3 gases (page 113)
- Laboratory Gas Safety System for safe use with hydrogen



NEW

TF1 12/60/600 with CC-T1 temperature programmer and optional vertical package

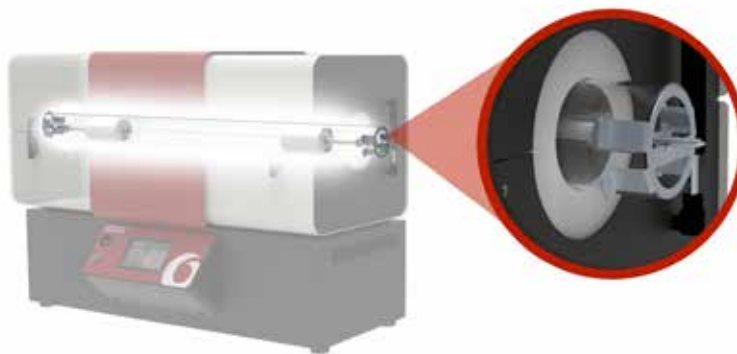
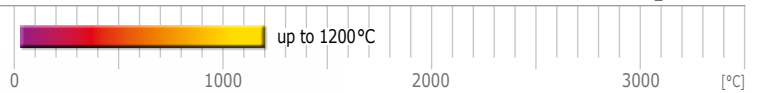

Detail showing the 'work tube package for air' installed in the furnace.

Work tube package for air shown with a TF1 12/60/600



Detail showing the work tube support bracket. Work tube packages with extended length work tubes include guards and support brackets as indicated in this image.

Work tube package for gas atmosphere shown with a TS1 12/60/600

Technical data – TF1 Mini

Model	Max. temp. [°C]	Heat-up time [mins]	Dimensions: Max. outer Ø accessory tube [mm]	Dimensions: Heated length [mm]	Recommended tube length		Dimensions: Horizontal External H x W x D [mm]	Dimensions: control box H x W x D [mm]	Uniform length ±5°C [mm]	Max. power [W]	Holding power [W]	Thermocouple type	Weight [kg]
					for use in air [mm]	for use with modified atmosphere [mm]							
TF1 11/32/150	1100	27	32	150	300	500	455 x 335 x 470	230 x 335 x 470	58	575	230	N	16

i Please note:

- Heat up time is measured to 100°C below max, using an empty quartz tube & insulation plugs
- Heat up rate when using an optional ceramic work tube must be limited to 5°C/min
- Holding power is measured at continuous operating temperature

- Uniform temperature lengths are measured with insulation plugs fitted
- Maximum continuous operating temperature is 100°C below maximum temperature

Technical data – TF1, TF3 Small

Model	Max. temp. [°C]	Heat up time [mins]	Dimensions: Max. outer Ø accessory tube [mm]	Dimensions: Heated length [mm]	Recommended tube length		Dimensions: Horizontal External H x W x D [mm]	Dimensions: control box H x W x D [mm]	Uniform length ±5°C [mm]	Max. power [W]	Thermocouple Type	Weight [kg]
					for use in air [mm]	for use with modified atmosphere [mm]						

Single Zone Tube Furnaces TF1

TF1 12/60/150	1200	40	60	150	430	600	575 x 485 x 480	230 x 485 x 480	93	750	N	31
TF1 12/60/300	1200	35	60	300	580	750	575 x 495 x 480	230 x 485 x 480	177	1500	N	37
TF1 12/60/450	1200	45	60	450	730	900	575 x 645 x 480	230 x 635 x 480	318	2000	N	49
TF1 12/60/600	1200	45	60	600	880	1050	575 x 795 x 480	230 x 785 x 480	474	2500	N	56

3-Zone Tube Furnaces TF3

TF3 12/60/450	1200	55	60	450	730	900	575 x 645 x 480	230 x 635 x 480	340	2000	N	49
TF3 12/60/600	1200	55	60	600	880	1050	575 x 795 x 480	230 x 785 x 480	501	2500	N	56

i Please note:

- Heat up time is measured to 100°C below max, using an empty quartz tube & insulation plugs
- Heat up rate when using an optional ceramic work tube must be limited to 5°C/min
- Holding power is measured at continuous operating temperature

- Uniform temperature lengths are measured with insulation plugs fitted at 100°C below maximum temperature
- Maximum continuous operating temperature is 100°C below maximum temperature

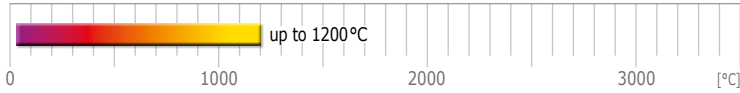

Work tube package for air + vertical stand and vertical tube support package shown with a TF1 12/60/600. Please see page 72 for detail images of the tube support package.



Work tube package for gas atmosphere + vertical stand and vertical tube support package shown with a TF1 12/125/400. Please see page 72 for detail images of the tube support package.

Technical data – TF1, TF3 Medium

Model	Max. temp. [°C]	Heat-up time [mins]	Dimensions: Max. outer Ø accessory tube [mm]	Dimensions: Heated length [mm]	Recommended tube length		Dimensions: Horizontal External H x W x D [mm]	Dimensions: control box H x W x D [mm]	Uniform length ± 5°C [mm]	Max. power [W]	Holding power [W]	Thermocouple type	Weight [kg]
					for use in air [mm]	for use with modified atmosphere [mm]							
Single Zone Tube Furnaces TF1													
TF1 12/125/400	1200	88	125	400	750	1000	655 x 665 x 575	230 x 655 x 480	284	1860	1240	N	71
TF1 12/125/600	1200	90	125	600	950	1200	655 x 865 x 575	230 x 855 x 480	456	2510	1500	N	89
TF1 12/125/800	1200	85	125	800	1150	1400	445 x 1065 x 575	230 x 655 x 480*	635	3160	1800	N	102
TF1 12/125/1000	1200	80	125	1000	1350	1600	445 x 1265 x 575	230 x 655 x 480*	847	3810	2100	N	120
TF1 12/125/1200	1200	82	125	1200	1550	1800	445 x 1465 x 575	230 x 655 x 480*	969	4460	2400	N	134
3-Zone Tube Furnaces TF3													
TF3 12/125/600	1200	90	125	600	950	1200	665 x 865 x 575	230 x 855 x 480	507	2510	1500	N	89
TF3 12/125/800	1200	85	125	800	1150	1400	445 x 1065 x 575	230 x 655 x 480*	715	3160	1800	N	102
TF3 12/125/1000	1200	80	125	1000	1350	1600	445 x 1265 x 575	230 x 655 x 480*	855	3810	2100	N	120
TF3 12/125/1200	1200	82	125	1200	1550	1800	445 x 1465 x 575	230 x 655 x 480*	1055	4460	2400	N	134

i Please note:

- Heat up time is measured to 100°C below max, using an empty quartz tube & insulation plugs
- Heat up rate when using an optional ceramic work tube must be limited to 5°C/min
- Holding power is measured at continuous operating temperature

- Uniform temperature lengths are measured with insulation plugs fitted at 100°C below maximum temperature
- Maximum continuous operating temperature is 100°C below maximum temperature
- * Furnace with separate control box

TS1, TS3 Split Tube Furnaces

With a maximum temperature of 1200 °C, the TS tube furnace range incorporates high-quality heating elements and innovative thermal insulation design to achieve first class performance delivering both reduced case temperatures and power consumption.

The extensive range features three main case sizes, small, medium and large, with multiple heated lengths available. Standard models can be configured to function with a single heated zone (TS1) or three heated zones (TS3) to extend the uniform heated length. Each heated zone of the TS3 benefits from its own dedicated controller and thermocouple.

The TS furnace body is split into two halves and hinged at the rear; pneumatic dampening struts at either end provide a smooth opening action. The ability to open the furnace makes it easier for operators to exchange work tubes, or insert vessels, such as reactors, with end flanges that would make them difficult to insert into a non-split furnace.

An accessory work tube is required to protect the heating elements and support the work piece. The TS range can accommodate work tubes with outside diameters ranging from 60 mm to 200 mm.

Standard features

- 1200 °C maximum operating temperature
- Programmable temperature controller with 24 segments.
 - TS1 fitted with Carbolite Gero EPC3016P1
 - TS3 fitted with Carbolite Gero CC-T1
- TS1 (1-zone) Heated length range from 150 to 1200 mm
- TS3 (3-zone) Heated length range from 450 to 1200 mm
- Accepts work tubes with outer diameters from 60 mm up to 200 mm
- Wire elements in high quality vacuum formed insulation ensure fast heat up, excellent temperature uniformity and short cool down times
- Furnace splits into two halves and accommodates tubes or samples fixed into a test rig
- Horizontal configuration: Small and medium mounted on control module for heated lengths up to 600 mm.
- Furnace body detachable from the control box to allow use of optional mounting arrangements (see pages 63–64)
- Horizontal configuration: Small and medium have a separate control module for heated lengths of 800 mm and above. Large always have a separate control module.
- Control module with 2 metre cable to furnace. Furnaces with 125 mm & 200 mm Ø include plug and socket.

NEW



TS1 12/125/600 with CC-T1 temperature programmer

Slide-in accessory work tubes and the use of tube adapters allow a single furnace to accommodate a variety of tube diameters. The work tubes themselves can easily be exchanged to meet the different physical or chemical requirements of a process.

Optional work tube packages enable users to equip the TS for operation under vacuum or modified atmosphere; for such applications, an extended work tube is required. Information can be found on pages 107.

NEW

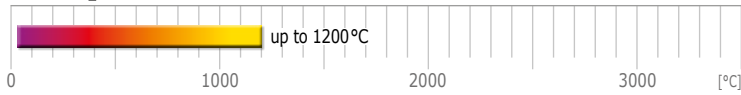
TS1 12/125/600 with CC-T1 temperature programmer



TS1 12/60/150 with CC-T1 and optional vertical package



TS1 12/200/600 with CC-T1 temperature programmer

Options (specify these at time of order)

- A range of sophisticated digital controllers, multi-segment programmers and data loggers with digital communication options is available (see page 100)
- Over-temperature protection (recommended to protect valuable contents & for unattended operation)
- A range of additional work tubes (page 106), end seals (page 110) and work tube packages (page 107) is available for use with modified atmosphere and/or vacuum
- Vacuum packages with a choice of rotary vane pump or turbomolecular pump are available (page 112)
- Wide choice of tube diameters and materials is available. See page 106 for tube materials
- Insulation plugs and radiation shields to prevent heat loss and improve uniformity
- Vertical mounting stand for the furnace body including bracket for mounting the furnace body to customer's equipment
- 4 m long extension cable to give a total 6 m length of cable between furnace body and control box
- Gas packages with manual valve (page 113)
- Gas packages with electrically operated valve for up to 3 gases (page 113)
- Laboratory Gas Safety System for safe use with hydrogen



TS1 12/60/150 with CC-T1 temperature programmer

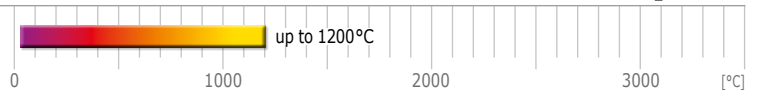

Work tube package for air + vertical stand and vertical tube support package shown with a TS1 12/60/600



Detail showing work tube guiding bracket. This is supplied with the vertical tube support package.

Detail showing the lower work tube support clamp. This is supplied with the vertical tube support package.



Work tube package for gas atmosphere + vertical stand and vertical tube support package shown with a TS1 12/125/400



Detail showing work tube guiding bracket. This is supplied with the vertical tube support package.

Detail showing the lower work tube support clamp. This is supplied with the vertical tube support package.

Technical data – TS1, TS3 Small

Model	Max. temp. [°C]	Heat-up time [mins]	Dimensions: Max. outer ø accessory tube [mm]	Dimensions: Heated length [mm]	Recommended tube length		Dimensions: Horizontal External H x W x D [mm]	Dimensions: control box H x W x D [mm]	Uniform length ± 5°C [mm]	Max. power [W]	Thermo-couple Type	Weight [kg]
					for use in air [mm]	for use with modified atmosphere [mm]						

Single Zone Split Tube Furnaces TS1

TS1 12/60/150	1200	99	60	150	430	600	575 x 485 x 480 (closed) 780 x 485 x 530 (open)	230 x 485 x 480	77	750	N	31
TS1 12/60/300	1200	46	60	300	580	750	575 x 495 x 480 (closed) 780 x 495 x 530 (open)	230 x 485 x 480	200	1500	N	37
TS1 12/60/450	1200	-	60	450	730	900	575 x 645 x 480 (closed) 780 x 645 x 530 (open)	230 x 635 x 480	303	2000	N	49
TS1 12/60/600	1200	-	60	600	880	1050	575 x 795 x 480 (closed) 780 x 795 x 530 (open)	230 x 785 x 480	460	2500	N	56

3-Zone Split Tube Furnaces TS3

TS3 12/60/450	1200	-	60	450	730	900	575 x 645 x 480 (closed) 780 x 645 x 530 (open)	230 x 635 x 480	335	2000	N	49
TS3 12/60/600	1200	63	60	600	880	1050	575 x 795 x 480 (closed) 780 x 795 x 530 (open)	230 x 785 x 480	470	2500	N	56

i Please note:

- Heat up time is measured to 100°C below max, using an empty quartz tube & insulation plugs
- Heat up rate when using an optional ceramic work tube must be limited to 5°C/min
- Holding power is measured at continuous operating temperature

- Uniform temperature lengths are measured with insulation plugs fitted at 100°C below maximum temperature
- Maximum continuous operating temperature is 100°C below maximum temperature

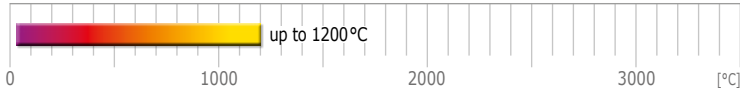

Technical data – TS1, TS3 Medium

Model	Max. temp. [°C]	Heat-up time [mins]	Dimensions: Max. outer Ø accessory tube [mm]	Dimensions: Heated length [mm]	Recommended tube length		Dimensions: Horizontal External H x W x D [mm]	Dimensions: control box H x W x D [mm]	Max. power [W]	Holding power [W]	Thermo-couple type	Weight [kg]
					for use in air [mm]	for use with modified atmosphere [mm]						

Single Zone Split Tube Furnaces TS1

TS1 12/125/400	1200	134	125	400	750	1000	665 x 665 x 575 (closed) 930 x 665 x 655 (open)	230 x 655 x 480	1860	1100	N	71
TS1 12/125/600	1200	150	125	600	950	1200	665 x 865 x 575 (closed) 930 x 865 x 655 (open)	230 x 855 x 480	2510	1450	N	89
TS1 12/125/800	1200	147	125	800	1150	1400	445 x 1065 x 575 (closed) 705 x 1065 x 655 (open)	230 x 655 x 480*	3160	1600	N	102
TS1 12/125/1000	1200	147	125	1000	1350	1600	445 x 1265 x 575 (closed) 705 x 1265 x 655 (open)	230 x 655 x 480*	3810	1900	N	120
TS1 12/125/1200	1200	154	125	1200	1550	1800	445 x 1465 x 575 (closed) 705 x 1465 x 655 (open)	230 x 655 x 480*	4460	2350	N	134

3-Zone Split Tube Furnaces TS3

TS3 12/125/600	1200	113	125	600	950	1200	665 x 865 x 575 (closed) 930 x 865 x 655 (open)	230 x 855 x 480	2510	1450	N	89
TS3 12/125/800	1200	141	125	800	1150	1400	445 x 1065 x 575 (closed) 705 x 1065 x 655 (open)	230 x 655 x 480*	3160	1600	N	102
TS3 12/125/1000	1200	134	125	1000	1350	1600	445 x 1265 x 575 (closed) 705 x 1265 x 655 (open)	230 x 655 x 480*	3810	1900	N	120
TS3 12/125/1200	1200	138	125	1200	1550	1800	445 x 1465 x 575 (closed) 705 x 1465 x 655 (open)	230 x 655 x 480*	4460	2350	N	134

i Please note:

- Heat up time is measured to 100°C below max, using an empty quartz tube & insulation plugs
- Heat up rate when using an optional ceramic work tube must be limited to 5°C/min
- Holding power is measured at continuous operating temperature

- Uniform temperature lengths are measured with insulation plugs fitted at 100°C below maximum temperature

- Maximum continuous operating temperature is 100°C below maximum temperature

* Furnace with separate control box

Technical data – TS1, TS3 Large

Model	Max. temp. [°C]	Heat-up time [mins]	Dimensions: Max. outer Ø accessory tube [mm]	Dimensions: Heated length [mm]	Recommended tube length		Dimensions: Horizontal External H x W x D [mm]	Dimensions: control box H x W x D [mm]	Max. power [W]	Holding power [W]	Thermo-couple type	Weight [kg]
					for use in air [mm]	for use with modified atmosphere [mm]						

Single Zone Split Tube Furnaces TS1

TS1 12/200/600	1200	62	200	600	1300	1300	540 x 1015 x 670 (closed) 855 x 1015 x 760 (open)	230 x 655 x 480*	6600	3400	N	127
TS1 12/200/1200	1200	80	200	1200	1900	1900	540 x 1615 x 670 (closed) 855 x 1615 x 760 (open)	230 x 655 x 480*	11400	3800	N	192

3-Zone Split Tube Furnaces TS3

TS3 12/200/600	1200	62	200	600	1300	1300	540 x 1015 x 670 (closed) 855 x 1015 x 760 (open)	230 x 655 x 480*	6600	3400	N	127
TS3 12/200/1200	1200	80	200	1200	1900	1900	540 x 1615 x 670 (closed) 855 x 1615 x 760 (open)	230 x 655 x 480*	11400	3800	N	192

i Please note:

- Heat up time is measured to 100°C below max, using an empty quartz tube & insulation plugs
- Heat up rate when using an optional ceramic work tube must be limited to 5°C/min
- Holding power is measured at continuous operating temperature

- Uniform temperature lengths are measured with insulation plugs fitted at 100°C below maximum temperature

- Maximum continuous operating temperature is 100°C below maximum temperature

* Furnace with separate control box

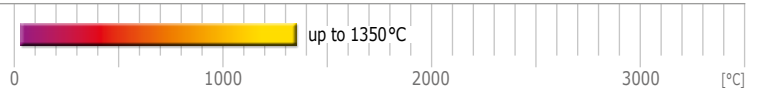

FHA, FHC – Horizontal and Vertical Tube Furnaces

The FHA, single zone, and FHC, 3-zone, tube furnaces can be used either vertically or horizontally and have a maximum operating temperature of 1350°C.

The extensive F range of tube furnaces is offered with a wide range of accessories. The furnaces comprise ceramic fibre modules with a high quality 5 mm APM wire heating element mounted in the insulation, held in position by a ceramic holding ridge. The low thermal mass ceramic fibre insulation ensures low energy consumption and allows fast heating rates. The control thermocouple is a high grade type S thermocouple. Additionally, the tube furnace is available with up to 8 heating zones for the most precise temperature control and uniformity.

Standard features

- 1350°C maximum operating temperature
- Programmable temperature controller with 24 segments.
 - FHA fitted with Carbolite Gero EPC3016P1
 - FHC fitted with Carbolite Gero CC-T1
- Over-temperature controller with independent thermocouple
- Accepts work tubes with outer diameters up to 110 mm
- Heated lengths of 200, 500, 750, 1000 or 1250 mm
- Use in horizontal or vertical orientation
- Exceptional lifetime and temperature stability
- High grade thermocouple type S
- Low thermal mass ceramic fibre insulation
- High quality 5 mm APM wire heating element
- Furnace fitted with separate control box with 3 m cable, plug and socket
- **NEW** Ethernet communications

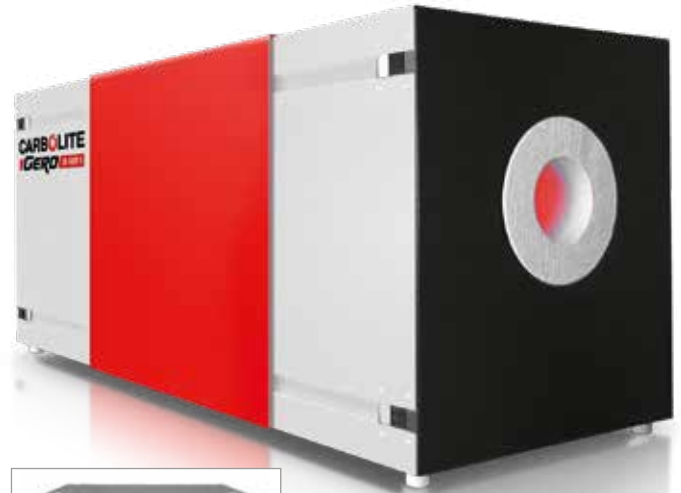

FHA 13/80/500



Control module with optional CC-T1 touchscreen programmer

Options (specify these at time of order)

- A range of sophisticated digital controllers, multisegment programmers and data loggers with digital communication options is available (see page 100)
- Wide choice of tube diameters and materials is available. See page 106 for tube materials
- 'L' stand for vertical usage
- Insulation plugs & radiation shields to prevent heat loss & improve uniformity (see page 110)
- Modified atmosphere and vacuum assemblies are available (see page 111)
- Larger tube diameters on request
- Vacuum packages with a choice of rotary vane pump or turbomolecular pump are available (page 112)
- Oxygen sensor for inert gas packages
- 6 m length of cable between furnace body and control box with plug and socket
- Laboratory Gas Safety System for safe use with hydrogen



FHA 13/110/1000 with optional basic inert gas package and optional L-stand

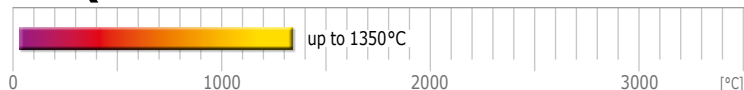

FHA 13/80/500 with optional CC-T1 controller, voltage/current display and high vacuum capable inert gas package. Rotary vane pumps and turbo pumps available (see page 112)

Technical data

Tube furnace FHA (single zone) and FHC (three zones) both available in horizontal and vertical arrangement (with optional 'L' stand)

Model	Max. temp. [°C]	Dimensions: Max. outer Ø accessory tube [mm]	Dimensions: Heated length [mm]	Recommended tube length		Dimensions: External furnace H x W x D [mm]	Furnace weight [kg]	Dimensions: Control module H x W x D* [mm]	Control module weight [kg]	Uniform length ± 5°C [mm]	Max. power [W]
				for use in air [mm]	for use with modified atmosphere [mm]						

Horizontal and Vertical Tube Furnaces (may need further equipment) FHA

FHA 13/32/200	1350	32	200	390	925	420 x 400 x 350	25	500 x 550 x 700	50	100	1200
FHA 13/32/500	1350	32	500	690	1225	420 x 700 x 350	30	500 x 550 x 700	50	250	2400
FHA 13/50/200	1350	50	200	390	925	420 x 400 x 350	30	500 x 550 x 700	50	100	1500
FHA 13/50/500	1350	50	500	690	1225	420 x 700 x 350	35	500 x 550 x 700	50	250	3600
FHA 13/50/750	1350	50	750	940	1475	420 x 950 x 350	40	850 x 550 x 700	60	375	5400
FHA 13/80/200	1350	80	200	390	925	420 x 400 x 350	35	500 x 550 x 700	50	100	2100
FHA 13/80/500	1350	80	500	690	1225	420 x 700 x 350	40	500 x 550 x 700	60	200	5200
FHA 13/80/750	1350	80	750	940	1475	420 x 950 x 350	50	850 x 550 x 700	70	375	7800
FHA 13/80/1000	1350	80	1000	1190	1725	420 x 1200 x 350	80	850 x 550 x 700	90	500	10400
FHA 13/110/500	1350	110	500	690	1225	590 x 700 x 520	55	850 x 550 x 700	70	250	7800
FHA 13/110/750	1350	110	750	940	1475	590 x 950 x 520	70	850 x 550 x 700	90	375	11500
FHA 13/110/1000	1350	110	1000	1190	1725	590 x 1200 x 520	100	1100 x 1200 x 700	90	500	16000
FHA 13/110/1250	1350	110	1250	1440	1975	590 x 1450 x 520	130	1100 x 1200 x 700	90	610	20000

3-Zone Horizontal and Vertical Tube Furnaces (may need further equipment) FHC

FHC 13/32/500	1350	32	500	690	1225	420 x 700 x 350	30	500 x 550 x 700	50	350	2400
FHC 13/50/500	1350	50	500	690	1225	420 x 700 x 350	35	500 x 550 x 700	50	350	3600
FHC 13/50/750	1350	50	750	940	1475	420 x 950 x 350	40	850 x 550 x 700	60	550	5400
FHC 13/80/500	1350	80	500	690	1225	420 x 700 x 350	40	500 x 550 x 700	60	350	5200
FHC 13/80/750	1350	80	750	940	1475	420 x 950 x 350	50	850 x 550 x 700	70	550	7800
FHC 13/80/1000	1350	80	1000	1190	1725	420 x 1200 x 350	80	850 x 550 x 700	90	800	10400
FHC 13/110/500	1350	110	500	690	1225	590 x 700 x 520	55	850 x 550 x 700	70	300	7800
FHC 13/110/750	1350	110	750	940	1475	590 x 950 x 520	70	850 x 550 x 700	90	500	11500
FHC 13/110/1000	1350	110	1000	1190	1725	590 x 1200 x 520	100	1100 x 1200 x 700	90	750	16000
FHC 13/110/1250	1350	110	1250	1440	1975	590 x 1450 x 520	130	1100 x 1200 x 700	90	950	20000

i Please note:

- Heat up rate when using an optional ceramic work tube must be limited to 5°C/min
- * Further to the depth of the control module 150 mm for the power plugs and other plugs needs to be added

- The power supply is based on 200 – 240 V for 1 phase and 380 – 415 V for 3 phase power
- * Minimum uniform length in horizontal furnace with insulation plugs fitted at 100°C below max. temperature

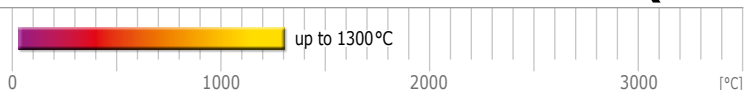

FST, FZS – Horizontal and Vertical Split Tube Furnaces

The FST, single zone, and FZS, 3-zone, split tube furnaces can be used either vertically or horizontally and have a maximum operating temperature of 1300°C.

The split heating module allows either easy positioning of the work tube or positioning around reactors which have fixed end flanges. The split design may also allow faster cooling of the sample. Cooling channels are engineered into the housing to aid with convection cooling of the outer case. A handle is attached to the upper half of the split tube furnace with two quick-release clamps to safely unlock and lock the furnace. The two furnace halves are ceramic fibre modules with high quality APM wire heating elements mounted in the insulation, held in position by a ceramic holding ridge. A safety switch protects the operator by switching off the heating elements once the furnace is opened.



FST 13/70/500
with optional
CC-T1 controller



Control module with
optional CC-T1 touchscreen
programmer

Standard features

- 1300°C maximum operating temperature
- Programmable temperature controller with 24 segments.
 - FST fitted with Carbolite Gero EPC3016P1
 - FZS fitted with Carbolite Gero CC-T1
- Over-temperature controller with independent thermocouple
- Accepts work tubes with outer diameter up to 150 mm
- Single-zone heated lengths of 200, 500 or 1000 mm
- 3-zone heated lengths of 500 or 1000 mm
- Split design allows work tubes or reactors with fixed flanges to be accommodate
- For horizontal or vertical use
- Exceptionally long life time and temperature stability
- High grade type S thermocouple
- Low thermal mass ceramic fibre insulation
- High quality 5 mm APM wire heating elements
- Supplied with separate control box with 3 m cable, plug and socket
- **NEW** Ethernet communications

Options (specify these at time of order)

- A range of sophisticated digital controllers, multisegment programmers and data loggers with digital communication options is available (see page 100)
- Wide choice of tube diameters and materials is available. See page 106 for tube materials
- For split tube furnaces, robustly shaped ceramic half tubes are available to protect the heating elements and for sample holding
- 'L' stand for vertical and/or horizontal use
- Insulation plugs & radiation shields to prevent heat loss & improve uniformity (see page 110)
- Modified atmosphere and vacuum packages are available (see page 111)
- Vacuum packages with a choice of rotary vane pump or turbomolecular pump are available (page 112)
- Larger tube diameters
- Longer heated lengths
- Automated opening mechanism
- Flanges for inert gas counter flow
- Oxygen sensor for inert gas packages
- 6 m length of cable between furnace body and control box with plug and socket
- Gas packages with manual valve (page 113)
- Gas packages with electrically operated valve for up to 3 gases (page 113)
- Laboratory Gas Safety System for safe use with hydrogen



Custom designed 3-zone FZS 13/100/4500 with 4500 mm heated length, automated opening and APM work tube

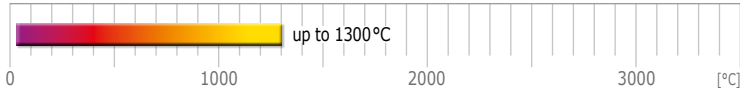

FZS 13/100/1000 with metallic APM tube

FZS 13/70/500 inert gas package for Ar and reactive gas O₂ equipped with double stage rotary vane pump.



Technical data

Model	Max. temp. [°C]	Dimensions: Max. outer Ø accessory tube [mm]	Dimensions: Heated length [mm]	Recommended tube length		Dimensions: External furnace H x W x D [mm]	Furnace weight [kg]	Dimensions: Control module H x W x D* [mm]	Control module weight [kg]	Uniform length ± 5°C [mm]	Max. power [W]
				for use in air [mm]	for use with modified atmosphere [mm]						

Single Zone Horizontal and Vertical Split Tube Furnaces FST (may need further equipment)

FST 13/40/200	1300	40	200	450	985	530 x 460 x 560	35	500 x 550 x 700	50	100	1500
FST 13/70/500	1300	70	500	670	1205	530 x 680 x 560	50	500 x 550 x 700	50	250	3000
FST 13/100/500	1300	100	500	670	1205	530 x 680 x 560	75	850 x 550 x 700	60	250	4000
FST 13/100/1000	1300	100	1000	1190	1725	530 x 1200 x 560	80	850 x 550 x 700	90	500	10400
FST 13/150/1000	1300	150	1000	1190	1725	590 x 1200 x 560	100	850 x 550 x 700	90	500	12000

3-Zone Horizontal and Vertical Split Tube Furnaces FZS (may need further equipment)

FZS 13/70/500	1300	70	500	670	1205	530 x 680 x 560	50	500 x 550 x 700	50	350	3000
FZS 13/100/500	1300	100	500	670	1205	530 x 680 x 560	75	850 x 550 x 700	60	300	4000
FZS 13/100/1000	1300	100	1000	1190	1725	530 x 1200 x 560	80	1100 x 1200 x 700	90	800	10400
FZS 13/150/1000	1300	150	1000	1190	1725	590 x 1200 x 560	100	1100 x 1200 x 700	90	600	12000
FZS 13/200/1000	1300	200	1000	1190**	1725**	690 x 1200 x 620	150	1100 x 1200 x 700	120		16000

3-Zone Horizontal Split Tube Furnaces FZS (may need further equipment)

FZS 13/100/1500	1300	100	1500	1690	2225	530 x 1700 x 560	120	1100 x 1200 x 700	120		14000
FZS 13/100/4500	1300	100	4500	on request	on request	2200 x 4700 x 1100	800	inside frame	-		45000
FZS 13/150/1500	1300	150	1500	1690**	2225**	590 x 1700 x 560	150	1100 x 1200 x 700	120		18000
FZS 13/150/4500	1300	150	4500	on request	on request	2200 x 4700 x 1200	950	inside frame	-		60000
FZS 13/200/1500	1300	200	1500	1690**	2225**	690 x 1700 x 620	200	1100 x 1200 x 700	160		22000

i Please note:

- Heat up rate when using an optional ceramic work tube must be limited to 5°C/min
- The power supply is based on 200–240 V for 1 phase and 380–415 V for 3 phase power
- Minimum uniform length in horizontal furnace with insulation plugs fitted at 100°C below max. temperature

*Further to the depth of the control module 150 mm for the power plugs and other plugs needs to be added

** (APM or quartz)

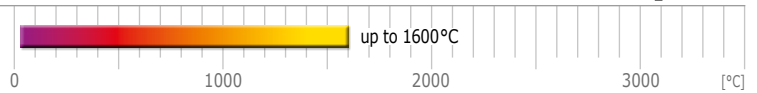

TF1, TF3 Tube Furnaces, 1600 °C

The TF tube furnaces achieve first class performance with low power consumption and low case temperature due to the use of high-quality heating elements and thermal insulation design. Maximum temperature of 1600 °C is available.

The range includes small and medium case sizes and two heated lengths in each size. The TF1 are single zone furnaces and the TF3 are three zone furnaces which further extend the uniform heated length.

Work tubes with outside diameters of 60 mm and 100 mm can be fitted. The use of an accessory slide-in work tube protects the heating element and is required to support the work piece.

The 3-zone TF3 furnaces provide excellent temperature uniformity resulting from division of the heated length into 3-zones with its own controller and thermocouple.

Should vacuum or a modified atmosphere be required, it is necessary to use a slide-in work tube of adequate length needed to fit end seals. In some circumstances a work tube that has different physical or chemical properties may be required. This information can be found on page 106. The benefit of this design is its flexibility; with the use of tube adapters the same furnace can be used with a variety of tube diameters.



TF1 16/60/300 with CC-T1 temperature programmer

NEW

TF1 16/100/450 with vertical package



Standard features

- 1600 °C maximum operating temperature
- Programmable temperature controller with 24 segments.
 - TF1 fitted with Carbolite Gero EPC3016P1
 - TF3 fitted with Carbolite Gero CC-T1
- Over temperature controller with independent thermocouple
- Ethernet Communications
- TF1 (1-zone) Heated length range from 180 to 600 mm
- TF3 (3-zone) Heated lengths of 450 and 600 mm
- Accepts work tubes with outer diameters from 60 mm up to 100 mm
- Silicon carbide elements ensure fast heat up and excellent temperature uniformity
- Horizontal configuration mounted on control module
- Furnace body detachable from the control box to allow use of optional mounting arrangements (see pages 63–64)
- Control module with 2 metre cable to furnace with plug and socket

Options (specify these at time of order)

- A range of sophisticated digital controllers, multi-segment programmers and data loggers with digital communication options is available (see page 100)
- A range of additional work tubes (page 106), end seals (page 110) and work tube packages (pages 107) is available for use with modified atmosphere and/or vacuum
- Vacuum packages with a choice of rotary vane pump or turbomolecular pump are available (page 112)
- Wide choice of tube diameters and materials is available. See page 106 for tube materials
- Insulation plugs and radiation shields to prevent heat loss and improve uniformity
- Vertical mounting stand for the furnace body including bracket for mounting the furnace body to customer's equipment
- 4 m long extension cable to give a total 6 m length of cable between furnace body and control box
- Gas packages with manual valve (page 113)
- Gas packages with electrically operated valve for up to 3 gases (page 113)
- Laboratory Gas Safety System for safe use with hydrogen

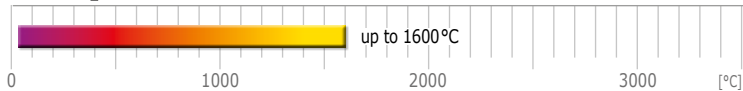

View inside

- 1) Centre zone heating element
- 2) End zone heating elements
- 3) Thermal insulation
- 4) 3-zone temperature control
- 5) Work tube

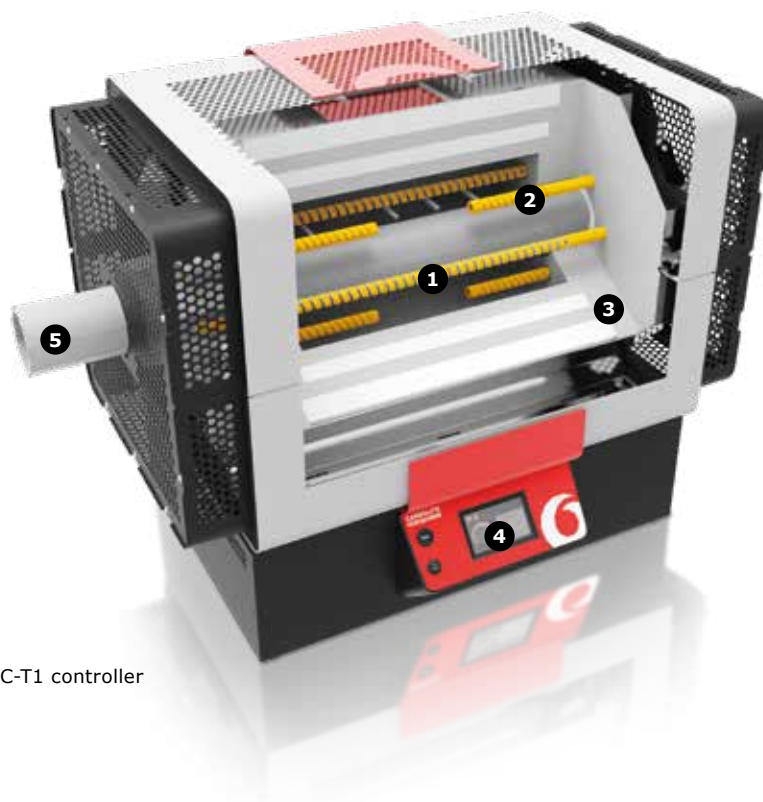

TF3 16/100/450 with CC-T1 controller

Technical data – TF1 1600 °C Small

Model	Max. temp. [°C]	Dimensions: Max. outer Ø accessory tube [mm]	Dimensions: Heated length [mm]	Recommended tube length		Dimensions: External H x W x D [mm]	Uniform length ± 5°C [mm]	Max. power [W]	Holding power [W]	Thermo-couple type	Weight [kg]
				for use in air [mm]	for use with modified atmosphere [mm]						

Single Zone High Temperature Tube Furnaces TF1 Small

TF1 16/60/180	1600	60	180	680	900	665 x 595 x 585	100	2500	1300	R	43
TF1 16/60/300	1600	60	300	800	1020	665 x 715 x 585	175	4000	1600	R	51

Technical data – TF1, TF3 1600 °C Medium

Model	Max. temp. [°C]	Dimensions: Max. outer Ø accessory tube [mm]	Dimensions: Heated length [mm]	Recommended tube length		Dimensions: External H x W x D [mm]	Uniform length ± 5°C [mm]	Max. power [W]	Holding power [W]	Thermo-couple type	Weight [kg]
				for use in air [mm]	for use with modified atmosphere [mm]						

Single Zone High Temperature Tube Furnaces TF1 Medium

TF1 16/100/450	1600	100	450	1030	1250	790 x 940 x 705	320	6000	3000	R	90
TF1 16/100/600	1600	100	600	1180	1400	790 x 1090 x 705	425	7000	3700	R	100

3-Zone High Temperature Tube Furnaces TF3

TF3 16/100/450	1600	100	450	1030	1250	790 x 940 x 705	375	6800	3000	R	90
TF3 16/100/600	1600	100	600	1180	1400	790 x 1090 x 705	460	8000	3700	R	100

i Please note:

- Heat up time is measured to 100°C below max, using an empty quartz tube & insulation plugs
- Heat up rate when using an optional ceramic work tube must be limited to 5°C/min
- Holding power is measured at continuous operating temperature

- Uniform temperature lengths are measured with insulation plugs fitted at 100°C below maximum temperature
- Maximum continuous operating temperature is 100°C below maximum temperature

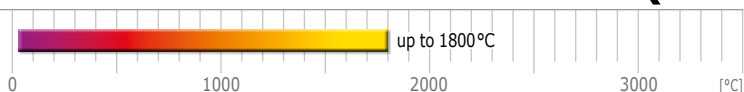

HTRH – High Temperature Horizontal Tube Furnaces

The Carbolite Gero high temperature tube furnaces HTRH can be used horizontally up to 1800°C.

The high-grade insulation materials guarantee low energy consumption and high heating rates due to their low thermal conductivity. The insulation and molybdenum disilicide (MoSi_2) heating elements are installed in the rectangular housing. The heating elements are vertically hanging (see 'view inside' figure) and can be replaced easily. At higher temperatures and in the presence of oxygen, MoSi_2 develops an oxide (SiO_2) layer, which protects the heating elements against further thermal or chemical corrosion.

Standard features

- 1800°C maximum operating temperature
- Programmable temperature controller with 24 segments.
 - HTRH fitted with Carbolite Gero EPC3016P1
 - HTRH-3 fitted with Carbolite Gero CC-T1
- Over-temperature protection
- Accepts work tubes with outer diameters up to 100 mm for use with modified atmosphere
- Accepts work tubes with outer diameters up to 200 mm for use in air
- Heated lengths of 100, 150, 250, 300, 600 or 900 mm
- High grade thermocouple type B
- Low thermal mass ceramic fibre insulation
- High quality MoSi_2 heating elements in a vertical, hanging position
- Rectangular housing with holes for convection cooling
- Available with 1–3 heating zones
- Furnace comes with separate control box with 3 m cable, plug and socket
- **NEW** Ethernet communications

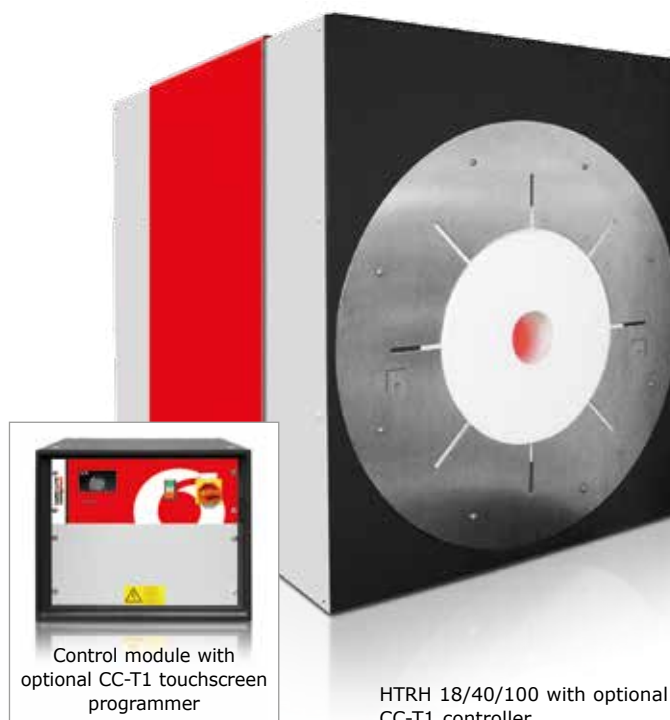

Options (specify these at time of order)

- A range of sophisticated digital controllers, multisegment programmers and data loggers with digital communication options is available (see page 100)
- A range of additional work tubes is available in a variety of materials (see page 106)
- Insulation plugs & radiation shields are strongly recommended for high temperature horizontal tube furnaces to prevent heat loss & improve uniformity (see page 110)
- Modified atmosphere and vacuum assemblies are available (see page 111)
- Vacuum packages with a choice of rotary vane pump or turbomolecular pump are available (page 112)
- Oxygen sensor for inert gas packages
- Gas packages with manual or automatic valve for up to 3 gases (page 113)
- 6 m long cable between furnace body and control box with plug and socket
- Laboratory Gas Safety System for safe use with hydrogen

View inside

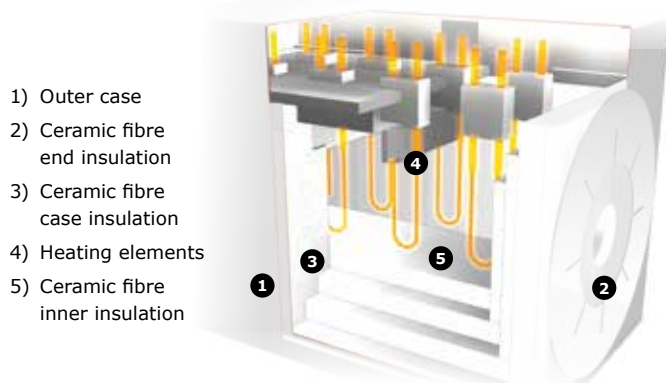

HTRH-3 furnace with three heating zones

Better temperature uniformity can be achieved by dividing the heated length into 3-zones.

Each zone is equipped with a dedicated thermocouple and controller, which is especially useful to preheat gases required for reactions inside the system. The HTRH tube furnaces do not include an integral work tube. The work tube must be selected as an additional item. The work tube length is dependent on the application and will vary if used with or without modified atmosphere or vacuum.

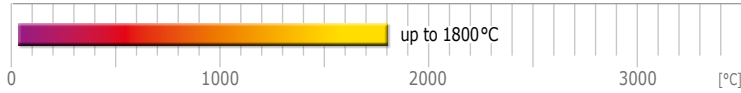

Horizontal High Temperature Tube Furnace HTRH 18/70/600 with optional EPC3008P10 programmer and optional high vacuum capable inert gas package (high vacuum capable up to 1450°C and up to 1800°C under normal pressure). Rotary vane pumps and turbo pumps optional available (see page 112).

Technical data

Model	Max. temperature [°C]	Dimensions: Max. outer Ø accessory tube [mm]	Dimensions: Heated length [mm]	Recommended tube length		Dimensions: External H x W x D [mm]	Furnace weight [kg]	Dimensions: Control module H x W x D* [mm]	Control module weight [kg]	Uniform length ± 5°C [mm]	Max. power [W]
				for use in air [mm]	for use with modified atmosphere [mm]						

Single Zone High Temperature Horizontal Tube Furnaces HTRH

HTRH __/40/100	1600	40	100	380	915	510 x 390 x 420	45	500 x 550 x 700	50	50	2200
HTRH __/40/250	1600, 1700, 1800	40	250	530	1065	510 x 540 x 420	45	500 x 550 x 700	50	125	3600
HTRH __/40/500	1600, 1700, 1800	40	500	780	1275	510 x 790 x 420	60	850 x 550 x 700	90	250	8000
HTRH __/70/150	1600, 1700	70	150	440	975	620 x 450 x 520	65	500 x 550 x 700	60	75	4500
HTRH __/70/300	1600, 1700, 1800	70	300	580	1115	620 x 590 x 520	65	850 x 550 x 700	60	150	6400
HTRH __/70/600	1600, 1700, 1800	70	600	880	1415	620 x 890 x 520	90	850 x 550 x 700	90	300	8000
HTRH __/100/150	1600	100	150	440	975	620 x 450 x 520	75	500 x 550 x 700	60	75	4800
HTRH __/100/300	1600, 1700, 1800	100	300	580	1115	620 x 590 x 520	90	850 x 550 x 700	90	150	7500
HTRH __/100/600	1600, 1700, 1800	100	600	880	1415	620 x 890 x 520	120	850 x 550 x 700	90	300	10900
HTRH __/150/600	1600, 1700, 1800	150	600	880	Not available	670 x 890 x 570	140	850 x 550 x 700	90		12000
HTRH __/200/600	1600, 1700, 1800	200	600	880	Not available	720 x 890 x 620	180	850 x 550 x 700	90		12000

3-Zone High Temperature Horizontal Tube Furnaces HTRH

HTRH-3 __/70/600	1600, 1700, 1800	70	600	880	1415	620 x 890 x 520	120	850 x 550 x 700	180	350	8000
HTRH-3 __/100/600	1600, 1700, 1800	100	600	880	1415	620 x 890 x 520	120	850 x 550 x 700	180	350	10900
HTRH-3 __/100/900	1600, 1700, 1800	100	900	1180	1715	680 x 1190 x 650	250	1100 x 1200 x 700	230		20000
HTRH-3 __/150/600	1600, 1700, 1800	150	600	880	Not available	670 x 890 x 570	180	850 x 550 x 700	180		12000
HTRH-3 __/150/900	1600, 1700, 1800	150	900	1180	Not available	680 x 1190 x 650	250	1100 x 1200 x 700	230		20000



Please note:

- Heat up rate when using an optional ceramic work tube must be limited to 5°C/min
- The power supply is based on 200–240 V for 1 phase and 380–415 V for 3 phase power
- Minimum uniform length in horizontal furnace with insulation plugs fitted at 100°C below max. temperature

- Maximum continuous operating temperature is 100°C below maximum temperature
- * Further to the depth of the control module 150 mm for the power plugs and other plugs needs to be added

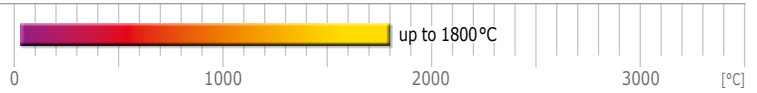

HTRV – High Temperature Vertical Tube Furnaces

The HTRV high temperature tube furnaces are designed for vertical orientation and operation up to 1800°C.

The high grade insulation material consisting of fibre plates provide low energy consumption and high heating rates due to their low thermal conductivity. The insulation and the molybdenum disilicide (MoSi_2) heating elements are installed in a rectangular housing. The heating elements hang vertically and can be easily replaced. At higher temperatures and in the presence of oxygen, MoSi_2 develops an oxide layer which protects the heating elements against further thermal or chemical corrosion.

With its wide range of accessories, the comprehensive HTRV range provides complete system solutions for ambitious thermal treatment at high temperatures.

Furnaces are supplied without a stand, allowing customers to build them into their own equipment. Optional 'L' stands are available allowing the furnaces to be self supporting.



HTRV 18/70/250 with optional CC-T1 controller, optional 'L' stand, optional voltage/current display and optional high vacuum/inert gas package (high vacuum possible up to 1450°C). Rotary vane and turbomolecular pumps available as options.

Standard features

- 1800°C maximum operating temperature
- Carbolite Gero EPC3016P1 programmable temperature controller with 24 segments
- Over-temperature controller with independent thermocouple
- Optimized for vertical usage
- Accepts work tubes with outer diameters up to 100 mm for use with modified atmosphere
- Accepts work tubes with outer diameters up to 200 mm for use in air
- Heated lengths of 100, 250 or 500 mm
- High grade type B thermocouple
- Low thermal mass ceramic fibre insulation
- Vertically hanging high quality MoSi_2 elements
- Rectangular housing with holes for convection cooling
- Furnace comes with separate control box with 3 m cable, plug and socket
- **NEW** Ethernet communications



Interior view of HTRV 18/70/250 at high temperature

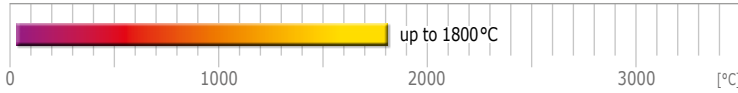

Options (specify these at time of order)

- A range of sophisticated digital controllers, multisegment programmers and data loggers with digital communication options is available (see page 100)
- A range of additional work tubes is available in a variety of materials (see page 106)
- Insulation plugs & radiation shields are strongly recommended for high temperature vertical tube furnaces to prevent heat loss & improve uniformity (see page 110)
- Modified atmosphere and vacuum packages are available (see page 111)
- Vacuum packages with a choice of rotary vane pump or turbomolecular pump are available (page 112)
- Stand for convenient and safe usage
- Oxygen sensor for inert gas packages
- Gas packages with manual or automatic valve for up to 3 gases (page 113)
- 6 m long cable between furnace body and control box with plug and socket
- Laboratory Gas Safety System for safe use with hydrogen



HTRV 17/150/250 with optional L-stand, current / voltage display and recommended fibre insulation plugs

Technical data

Model	Max. temperature [°C]	Dimensions: Max. outer Ø accessory tube [mm]	Dimensions: Heated length [mm]	Recommended tube length		Dimensions: External H x W x D [mm]	Furnace weight [kg]	Dimensions: Control module H x W x D* [mm]	Control module weight [kg]	Uniform length ± 5°C [mm]	Max. power [W]
				for use in air [mm]	for use with modified atmosphere [mm]						

High Temperature Vertical Tube Furnaces HTRV

HTRV ___/40/100	1600, 1700	40	100	355	890	365 x 455 x 455	30	500 x 550 x 700	50	50	2000
HTRV ___/40/250	1600, 1700, 1800	40	250	505	1040	515 x 455 x 455	40	500 x 550 x 700	50	125	3000
HTRV ___/40/500	1600, 1700	40	500	755	1290	765 x 455 x 455	65	850 x 550 x 700	60	250	6000
HTRV ___/70/100	1600, 1700	70	100	355	890	365 x 455 x 455	30	500 x 550 x 700	50	50	3000
HTRV ___/70/250	1600, 1700, 1800	70	250	505	1040	515 x 455 x 455	40	850 x 550 x 700	60	125	4800
HTRV ___/70/500	1600, 1700, 1800	70	500	755	1290	765 x 455 x 455	65	850 x 550 x 700	90	250	8000
HTRV ___/100/250	1600, 1700, 1800	100	250	505	1040	515 x 455 x 455	45	850 x 550 x 700	60	125	7000
HTRV ___/100/500	1600, 1700, 1800	100	500	755	1290	765 x 455 x 455	70	850 x 550 x 700	90	250	10400
HTRV ___/150/250	1600, 1700, 1800	150	250	505	Not available	515 x 580 x 580	55	850 x 550 x 700	90		8000
HTRV ___/150/500	1600, 1700, 1800	150	500	755	Not available	765 x 580 x 580	80	850 x 550 x 700	90		12000
HTRV ___/200/250	1600, 1700, 1800	200	250	505	Not available	515 x 580 x 580	70	850 x 550 x 700	90		10000
HTRV ___/200/500	1600, 1700, 1800	200	500	755	Not available	365 x 580 x 580	95	850 x 550 x 700	90		14000

i Please note:

- Heat up rate when using an optional ceramic work tube must be limited to 5°C/min
- The power supply is based on 200–240 V for 1 phase and 380–415 V for 3 phase power
- Minimum uniform length in horizontal furnace with insulation plugs fitted at 100°C below max. temperature

- Maximum continuous operating temperature is 100°C below maximum temperature
- * Further to the depth of the control module 150 mm for the power plugs and other plugs needs to be added

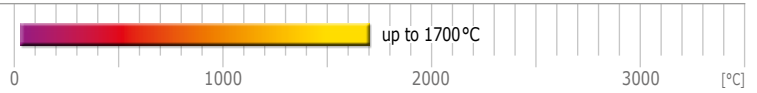

HTRV-A – High Temperature Vertical Split Tube Furnaces

The HTRV-A split tube furnaces have a maximum operating temperature of 1700 °C.

The split heating module allows either easy positioning of the work tube or positioning around reactors which have fixed end flanges. The split design may also allow faster cooling of samples. The control thermocouple is fitted in the centre of the heating zone. Cooling channels are engineered into the housing to aid with convection cooling of the outer case. The two furnace chamber halves consist of high grade insulation plates with vertically hanging MoSi_2 heating elements. A safety switch protects the operator by switching off the heating elements once the furnace is opened.

Furnaces are supplied without a stand, allowing customers to build them into their own equipment. Optional 'L' stands are available allowing the furnaces to be self supporting.

Standard features

- 1600 and 1700 °C maximum operating temperatures
- Carbolite Gero EPC3016P1 programmable temperature controller with 24 segments
- Over-temperature controller with independent thermocouple
- Designed for vertical use
- Accepts work tubes with outer diameters up to 100 mm for use with modified atmosphere
- Heated lengths of 120, 250, 500 or 700 mm
- High grade type B thermocouple
- Low thermal mass ceramic fibre insulation
- Vertically hanging high quality MoSi_2 heating elements
- Supplied with separate control box and 3 m cable, plug and socket
- **NEW** Ethernet communications



HTRV-A 17/100/700 with optional stand

View inside the HTRV-A

- 1) Outer case
- 2) Ceramic fibre end insulation
- 3) Ceramic fibre case insulation
- 4) Heating elements
- 5) Ceramic fibre inner insulation

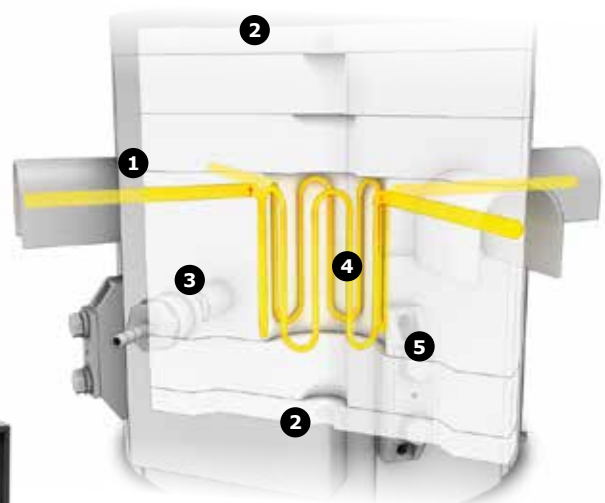

HTRV-A 17/70/250
with optional basic inert gas bundle



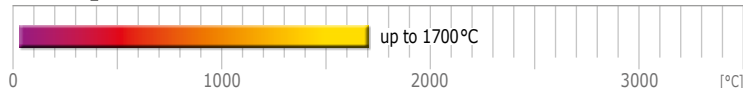

Options (specify these at time of order)

- A range of sophisticated digital controllers, multisegment programmers and data loggers with digital communication options is available (see page 100)
- A range of additional work tubes is available in a variety of materials (see page 106)
- Insulation plugs & radiation shields are strongly recommended for high temperature vertical tube furnaces to prevent heat loss & improve uniformity (see page 110)
- Modified atmosphere and vacuum packages are available (see page 111)
- Vacuum packages with a choice of rotary vane pump or turbomolecular pump are available (see page 112)
- Longer heated lengths
- Stand for convenient and safe usage
- Oxygen sensor for inert gas packages
- 6 m long cable between furnace body and control box with plug and socket
- Gas packages with manual or automatic valve for up to 3 gases (see page 113)
- Laboratory Gas Safety System for safe use with hydrogen



HTRV-A 17/70/250 with inert gas package

Technical data

Model	Max. temperature [°C]	Dimensions: Max. outer Ø accessory tube [mm]	Dimensions: Heated length [mm]	Recommended tube length		Dimensions: External H x W x D [mm]	Furnace weight [kg]	Dimensions: Control module H x W x D* [mm]	Control module weight [kg]	Uniform length ± 5°C [mm]	Max. power [W]
				for use in air [mm]	for use with modified atmosphere [mm]						

High Temperature Vertical Split Tube Furnace HTRV-A

HTRV-A __/70/120	1600	70	120	470	910	700 x 700 x 890 (closed with stand)	65	850 x 550 x 700	60	50	4800
HTRV-A __/70/250	1600, 1700	70	250	600	1040	800 x 600 x 890 (closed with stand)	75	850 x 550 x 700	90	125	6000
HTRV-A __/70/500	1600, 1700	70	500	850	1290	1050 x 700 x 890 (closed with stand)	120	850 x 550 x 700	90	250	13000
HTRV-A __/70/700	1600, 1700	70	700	1050	1490	1250 x 800 x 990 (closed with stand)	170	850 x 550 x 700	120	350	19000
HTRV-A __/100/500	1600, 1700	100	500	850	1290	1050 x 800 x 990 (closed with stand)	140	850 x 550 x 700	120		13000
HTRV-A __/100/700	1600, 1700	100	700	1050	1490	1250 x 800 x 990 (closed with stand)	170	850 x 550 x 700	120		19000

i Please note:

- Heat up rate when using an optional ceramic work tube must be limited to 5°C/min
- The power supply is based on 200–240 V for 1 phase and 380–415 V for 3 phase power
- Minimum uniform length in horizontal furnace with insulation plugs fitted at 100°C below max. temperature

- Maximum continuous operating temperature is 100°C below maximum temperature
- * Further to the depth of the control module 150 mm for the power plugs and other plugs needs to be added

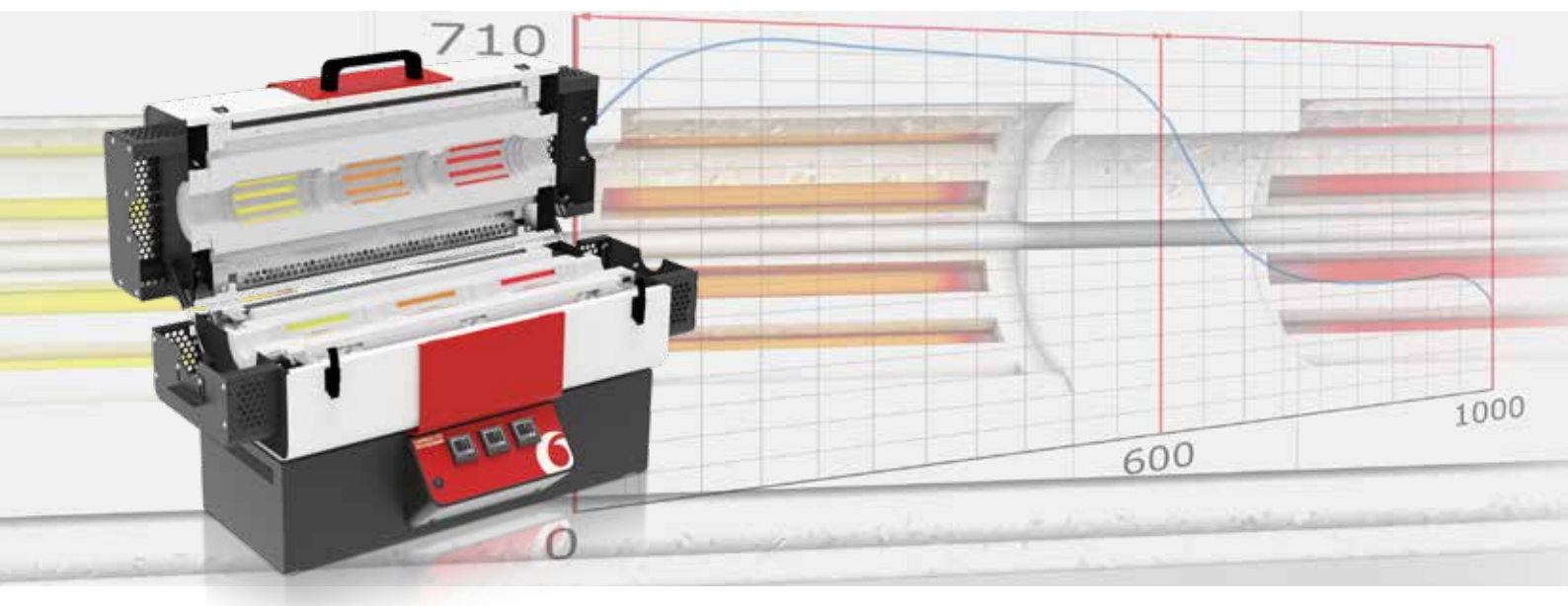

Gradient Tube Furnaces

The Carbolite Gero range of gradient tube furnaces are design to provide a temperature ramp along the length of a work tube.

A gradient tube furnace is divided into a number of heating 'zones' along the length of the furnace. Each zone has its own individual temperature controller which can be set to independent temperatures, achieving a pre-determined temperature profile along the work tube.

Some heat will naturally transfer between adjacent heating zones and therefore zone barriers are employed in the TG models to minimize this effect. The AZ models are not equipped with heat barriers. Examples of heating profiles are shown on each product page.

Chemical vapour transport (CVT) and physical vapour transport (PVT) reactions

Chemical vapour transport (CVT) and physical vapour transport (PVT) reactions

- The gradient furnace can be used to heat a reactor tube to provide the two distinct temperatures required in chemical vapour transport reactions
- Materials are vaporized in the hotter zone and condense in the cooler zone
- Extended tube furnace packages options are available to provide a sealed environment for this process
- Vacuum pump packages are also available if vacuum pressure is required
- High quality single crystals can be grown using this equipment

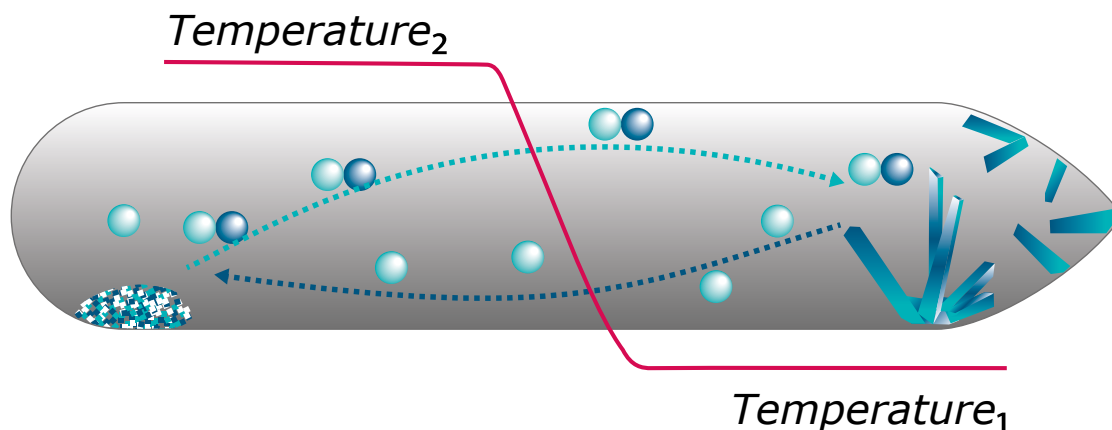

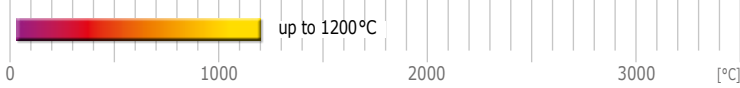

Heat Treatment

A sample could be moved between two temperature zones to achieve a desired heat cycle without waiting for a single zone furnace to heat or cool.

Temperature Gradient, Horizontal TG2 12/125/425.

80 mm OD worktube.

Setpoints: **zone 1: off, zone 2: 1100°C**

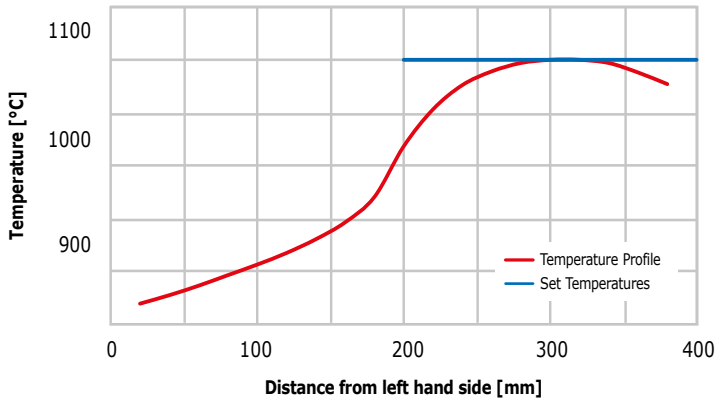

Temperature Gradient, Horizontal TG2 12/125/425.

80 mm OD worktube.

Setpoints: **zone 1: 1000°C, zone 2: 1100°C**

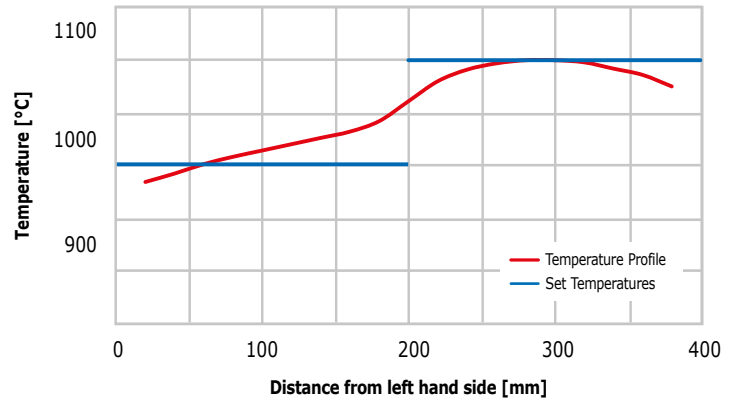

Temperature Gradient, Horizontal TG3 12/60/600.

60 mm OD worktube.

Setpoints: **zone 1: 1100°C, zone 2: 950°C, zone 3: 800°C**

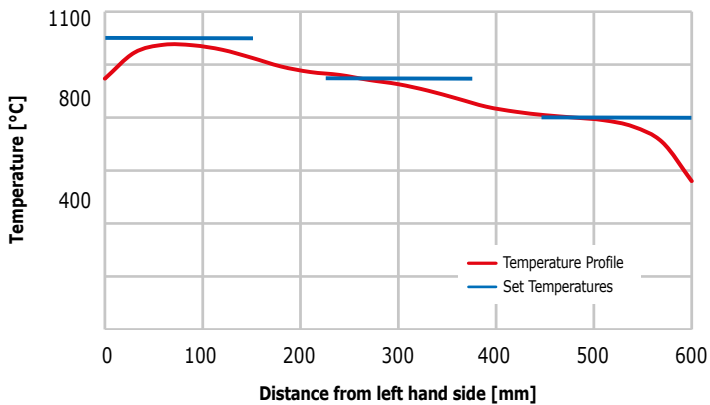

Temperature Gradient, Horizontal TG3 12/60/600.

60 mm OD worktube.

Setpoints: **zone 1: 1100°C, zone 2: off, zone 3: 400°C**

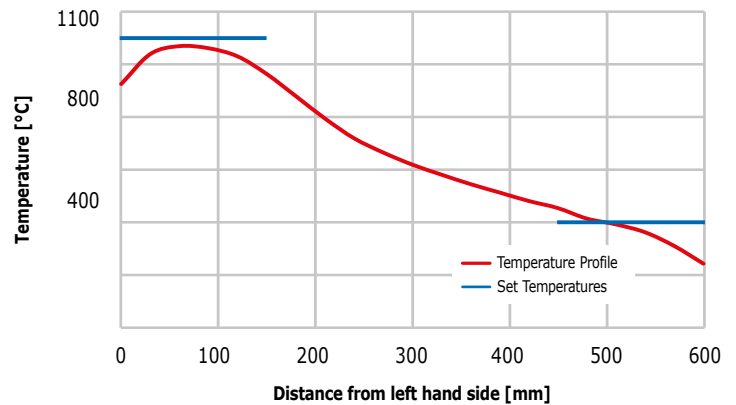

TG Compact Gradient Split Tube Furnaces

These compact split tube furnaces are specifically design to provide a temperature gradient along the length of the heated zones. They use free radiating wire elements embedded within the insulation of the furnace body. The benefit of this design is its flexibility; with the use of tube adapters the same furnace can be used with a variety of tube diameters.

The TG2 furnace has two independent zones and TG3 has three independent zones. They are split tube furnaces that comprise a furnace body which is hinged and split into two halves along its length.



TG2 12/125/425

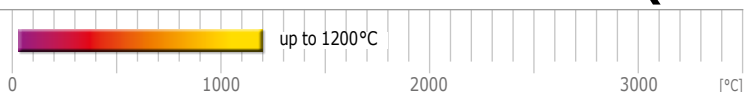

This makes exchange of work tubes easier and also enables the furnace to be used with reactors or work tubes where end flanges would make insertion into a non-split furnace difficult. The TG2 furnace includes a 25 mm long unheated zone barrier between the two 200 mm heated zones and the TG3 has two 75 mm long unheated zone barriers between the three 150 mm heated zones. Each heated zone has its own temperature controller and thermocouple. This range of tube furnaces does not include an integral work tube which must be selected as an additional item. Should vacuum or a modified atmosphere be required, it is necessary to use a separate slide-in work tube of adequate length needed to fit end seals. This information can be found on pages 106. The use of a separate work tube has the advantage of protecting the heating elements from damage or contamination.

Note: The temperature gradient achievable is influenced by work tube diameter. Larger gradients will be achieved with smaller diameter work tubes because heat transfer between zones will be less.



TG3 12/60/600

Standard features

- 1200°C maximum operating temperature
- Each zone has a Carbolite Gero EPC3016P1 programmable temperature controller with 24 segments
- TG3 12/60/600. Overall heated length of 600 mm divided into three 150 mm heated zones with two 75 mm unheated zone barriers. Accepts work tubes with outer diameters up to 60 mm
- TG2 12/125/425. Overall heated length of 425 mm divided into two 200 mm heated zones with a 25 mm unheated zone barrier. Accepts work tubes with outer diameters up to 125 mm
- Wire elements in high quality vacuum formed insulation ensure fast heat up, excellent temperature control and short cool down times
- Furnace splits into two halves and accommodates tubes or samples fixed into a test rig
- Furnace body detachable from the control box to allow use of optional mounting arrangements (see pages 63–64)
- Control module with 2 metre cable to furnace. Furnaces with 125 mm Ø include plug and socket.
- **NEW** RS485 communications

Options (specify these at time of order)

- Over-temperature protection for each heated zone (recommended to protect valuable contents & for unattended operation)
- A range of additional work tubes (page 100), end seals (page 110) and work tube packages (pages 107) is available for use with modified atmosphere and/or vacuum
- Vacuum packages with a choice of rotary vane pump or turbomolecular pump are available (page 112)
- Wide choice of tube diameters and materials is available.
- See page 106 for tube materials
- Insulation plugs and radiation shields to prevent heat loss
- Vertical mounting stand for the furnace body including bracket for mounting the furnace body to customer's equipment
- 4 m long extension cable to give a total 6 m length of cable between furnace body and control box
- Gas packages with manual valve (page 113)
- Gas packages with electrically operated valve for up to 2 gases (page 113)

Technical data

Model	Max. temp. [°C]	Heat-up time [mins]	Dimensions: Max. outer Ø accessory tube [mm]	Dimensions: Overall heated length [mm]	Recommended tube length		Dimensions: External Furnace H x W x D [mm]	Dimensions: Control module H x W x D [mm]	Max. power [W]	Thermo-couple type	Weight [kg]
					for use in air [mm]	for use with modified atmosphere [mm]					
TG3 12/60/600	1200	-	60	600	880	1050	575 x 795 x 480	230 x 785 x 480	2000	N	56
TG2 12/125/425	1200	134	125	425	750	1000	665 x 665 x 575	230 x 655 x 480	1860	N	71

i Please note:

- Heat up time is measured to 100°C below max, using an empty quartz tube & insulation plugs
- Heat up rate when using an optional ceramic work tube must be limited to 5°C/min
- Holding power is measured at continuous operating temperature

- Temperature gradients are measured with insulation plugs fitted
- Maximum continuous operating temperature is 100°C below maximum temperature

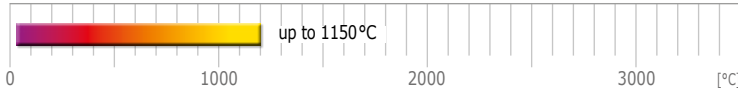

TSR – Rotating Horizontal Split Tube Furnaces

The range of Carbolite Gero horizontal rotating tube furnaces offers the benefits of simultaneous heating and mixing of the sample, in addition to the use of an inert atmosphere.

The furnaces are suitable for continuous material processing. Residence time in the heated zone depends on the degree of inclination and the rotating speed (which can be controlled by the customer) and the length of the working tube, in addition to the flow properties of the material.

The design of the split furnace, drive system and feeder/collection assemblies allows the work tube to be easily removed and replaced.

NEW



TSR 11/1000

Standard features

- 1150 °C maximum operating temperature; normal operating temperature range 650 °C - 1050 °C
- Heated lengths of 1000 mm
- Single zone models fitted with Carbolite Gero EPC3016P1 programmable temperature controller with 24 segments
- 3-zone models fitted with Carbolite Gero CC-T1 programmable temperature controller with 24 segments
- Accepts work tube with outer diameter of 125 mm
- Adjustable inclination and rotation speeds offers flexibility of residence time
- Work tube rotation speed 1.5 to 10.0 revolutions per minute
- 5 litre capacity vibratory feeder and hopper
- The temperature controllers and associated equipment are housed within the integral control box
- Wire elements in high quality vacuum formed insulation ensure fast heat up, excellent temperature uniformity and short cool down times

The single zone and 3-zone split tube furnaces have a maximum operating temperature of 1150 °C and a heated lengths of 1000 mm. The angle of inclination can be easily adjusted between horizontal and 10°. The quartz work tube has an outer diameter of 125 mm. A safety switch automatically prevents heating and tube rotation when the furnace is opened.

It is essential to discuss your application with Carbolite Gero to ensure the suitability of the material for use in this equipment. Carbolite Gero cannot accept responsibility for your process due to the possibility of the material becoming sticky when heated and therefore not flow through the work tube.

Options (specify these at time of order)

- Metallic (up to 800 °C) work tubes
- Inert gas packages available on request

Technical data

Model	Max. temperature [°C]	Dimensions: Max. outer Ø accessory tube [mm]	Dimensions: Heated length [mm]	Work tube length [mm]	Dimensions: External H x W x D [mm]	Max. power [W]
Single Zone Rotating Horizontal Split Tube Furnace TSR1						
TSR1 11/125/1000	1150	125	1000	2000	1830 x 3150 x 700	3810
3-Zone Rotating Horizontal Split Tube Furnace TSR3						
TSR3 11/125/1000	1150	125	1000	2000	1830 x 3150 x 700	3810

i Please note:
- Maximum continuous operating temperature is 100°C below maximum temperature

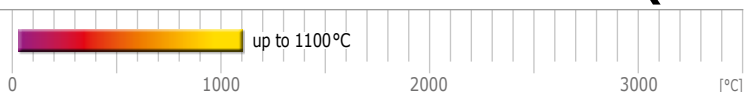

TSO - Rotary Reactor Tube Furnaces

The rotary reactor furnaces combine many of the advantages of a fluidised bed reactor with those of a rotary kiln, all within a laboratory scale unit.

The TSO vessel oscillates, simultaneously heating and mixing samples in air or, with the addition of the optional gas connection kit, within a controlled atmosphere. This method of processing overcomes the longer reaction times required in standard chamber or tube furnaces.

NEW



TSO1 11/400 with CC-T1 controller, optional gas connection kit and inert gas package

Standard Features

- The variable speed electric drive system oscillates the reactor tube through 315°
- Quartz reaction vessel with smooth inner surface
- A safety interlock switch cuts power to the rotation mechanism when the heating chamber is open
- 1100°C maximum operating temperature
- Programmable temperature controller with 24 segments.
 - TSO1 fitted with Carbolite Gero EPC3016P1
 - TSO3 fitted with Carbolite Gero CC-T1
- Wire elements in high quality vacuum formed insulation ensure fast heat up, excellent temperature uniformity and short cool down times
- Horizontal configuration: 400 & 600 versions mounted on control module
- Furnace body detachable from the control box
- Horizontal configuration: 800 & 1000 versions have a separate control module
- Control module with 2 metre cable to furnace with plug and socket
- Maximum reaction vessel load 3 kg, for maximum volume see data table

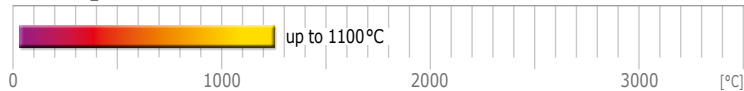

Options (specify these at time of order)

- TSO gas connection kit comprising of end seals and pipework
- Optional upgrade to a vessel with a fluted internal surface to enhance the mixing of powders
- Gas packages with manual valve (see page 113)
- Gas packages with electrically operated valve for up to 3 gases (see page 113)
- Gas enters and exits the reactor through flexible silicone rubber tubes
- A range of sophisticated digital controllers, multi-segment programmers and data loggers with digital communication options is available (see page 100)
- Over-temperature protection (recommended to protect valuable contents & for unattended operation)
- 4 m long extension cable to give a total 6 m length of cable between furnace body and control box

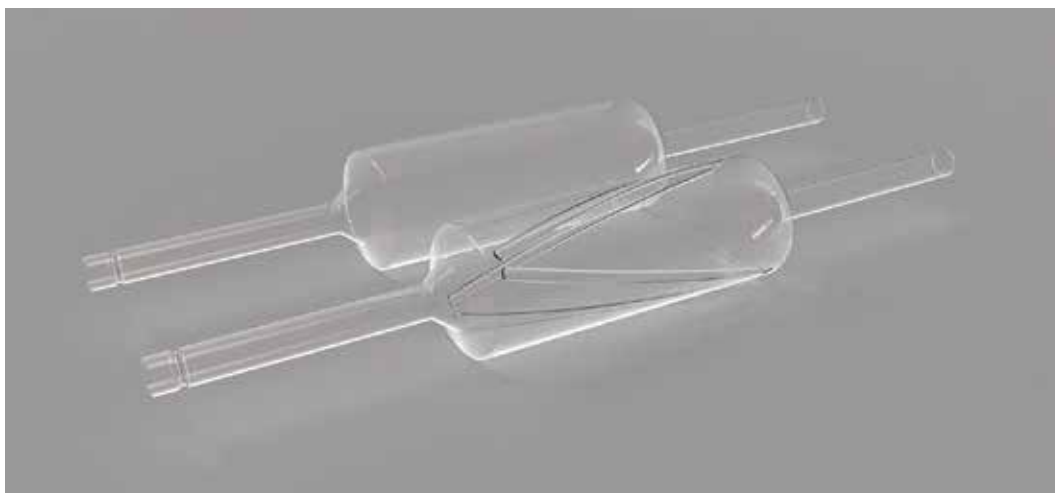

Quartz reaction vessel with smooth inner surface and optional fluted internal surface

Technical data

Model	Max. temperature [°C]	Max. continuous operating temp. [°C]	Dimensions: Reaction chamber dimensions [mm]	Dimensions: Reaction vessel capacity [ml]	Dimensions: Oscillation frequency per min	Dimensions: Rotation in each direction	Dimensions: External H x W x D [mm] lid down	Weight [kg]
TS01 11/400	1100	1100	Ø 120 x 330 long	620	1 to 8	315°	665 x 1115 x 575 (closed) 930 x 1115 x 655 (open)	88
TS01 11/600	1100	1100	Ø 120 x 530 long	990	1 to 8	315°	665 x 1315 x 575 (closed) 930 x 1315 x 655 (open)	106
TS01 11/800	1100	1100	Ø 120 x 730 long	1360	1 to 8	315°	445 x 1515 x 575 (closed) 705 x 1515 x 655 (open)	119
TS01 11/1000	1100	1100	Ø 120 x 930 long	1740	1 to 8	315°	445 x 1715 x 575 (closed) 705 x 1715 x 655 (open)	137
TS03 11/600	1100	1100	Ø 120 x 530 long	990	1 to 8	315°	665 x 1315 x 575 (closed) 930 x 1315 x 655 (open)	106
TS03 11/800	1100	1100	Ø 120 x 730 long	1360	1 to 8	315°	445 x 1515 x 575 (closed) 705 x 1515 x 655 (open)	119
TS03 11/1000	1100	1100	Ø 120 x 930 long	1740	1 to 8	315°	445 x 1715 x 575 (closed) 705 x 1715 x 655 (open)	137



Please note:

- External dimensions and weight includes the TS medium furnace and a TSO gas connection kit

Coal and Coke Test Equipment

The range of coal and coke tests carried out in a furnace or oven has grown over many years, and Carbolite Gero has responded to the requirements of each new standard by designing a furnace to suit the specific requirements of each test method. As a result, Carbolite Gero products have become established as the standard equipment used in many coal laboratories, inspection companies, power plants and steelworks throughout the world. The range includes international coal and coke testing and iron ore evaluation test methods, including ISO, ASTM, EN, BS, and DIN. Some examples follow, but this is not a complete list.



Coal, Coke & Iron Ore Testing Furnaces

In addition to the equipment shown in this catalogue, Carbolite Gero manufactures a comprehensive range of furnaces for coal, coke and iron ore testing. A new catalogue is available to download from our website, or enquire at info@carbolite-gero.com.

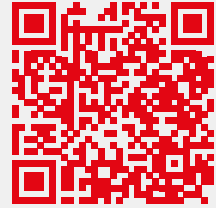

Download the catalogue now!

Coal ashing furnaces

The AAF range of ashing furnaces suits many coal (and other materials) ashing tests, including ISO 334 & ISO 1171:2010 Solid mineral fuels – determination of ash, ASTM D2361 & D3174-04(2010) Standard Test Method for Ash in the Analysis Sample of Coal and Coke from Coal, BS 1016 part 4.

- Maximum temperature 1100°C
- Continuous preheated airflow, to ensure temperature uniformity of better than $\pm 10^\circ\text{C}$ throughout the uniform volume
- Constant airflow held close over the samples to promote burning (AAF 11/3 and AAF 11/7 models have 4-5 air changes per minute)
- Traditional muffle heated chamber gives good resistance to abrasion and vapour attack (AAF 11/3 & AAF 11/7)
- A range of sophisticated controllers and programmers is available, along with data logging equipment

www.carbolite-gero.com/products/chamber-furnaces/ashing-furnaces/aaf-11-3-11-7/function-features/



Coal ash fusibility furnaces (CAF G5)

The CAF G5 is designed to test coal ash fusibility and optionally the increasingly popular determination of biomass or solid recovered fuels testing and conforms to the Standards ISO 540:2008; ASDTM D 1857 / D1857M - 04 (2010); DIN 51730:2007-09; DD CEN/TS 15370-1:2006 (biomass) and PD CEN/TR 15404:2010 (SRF)

- 1600°C tube furnace with integral SiC elements
- 3508P1 automatic temperature programmer with multiple PID control
- Analysis software which can be used in fully automatic or manual modes
- Software zoom function to enable accurate post-test analysis of individual samples with improved resolution
- Tests up to 8 test pieces at any one time
- One configurable grid assigned to each test piece

www.carbolite-gero.com/products/application-specific-furnaces/coal-coke-test-equipment/coal-ash-fusibility-test-furnace/function-features/



Carbon anode reactivity test furnace for testing in CO₂ or air (CRF/1)

Custom built units to determine the reactivity of carbon anodes used in the production of aluminium in either CO₂ or Air. Used for testing in compliance with the requirements of ISO 12981-1, BS 6043-2.20.1 or ISO 12982-1.

- Maximum temperature: 1000 °C
- Heated length 200 mm
- Maximum outer dimension of accessory tube 40 mm
- External dimensions (H x W x D): 660 x 660 x 475 mm

www.carbolite-gero.com/products/application-specific-furnaces/coal-coke-test-equipment/crf-co2-reactivity-test-furnace/function-features/



Iron ore reducibility – ISO 4695 – 4696-1 Combined Test Unit

Reducibility may be defined as a measure of the ease with which oxygen combined with iron can be removed from natural or processed iron ores by a reducing gas, which is expressed as the rate of reduction at an atomic ratio O/Fe = 0.9, relative to the iron (III) state. Test consists of isothermal reduction of a test portion at a specified size range in a fixed bed at a temperature of 950 °C using a reducing gas consisting of CO and N₂.

- Maximum temperature: 1100 °C
- Three heated zones over 700 mm
- Balance to determine the loss in mass of the reduced sample with a resolution of 0.1 g connected to the retort during the entire process cycle
- Dual loop cascade control
- Supplied with retort
- Over-temperature protection
- Flame failure gas safety system

www.carbolite-gero.com/products/application-specific-furnaces/coal-coke-test-equipment/pilot-plant/function-features/



PTC – Thermocouple Calibration Furnaces

The PTC thermocouple calibration furnace is designed to provide a high stability portable heat source for the calibration of thermocouples using the comparison method.

- 1200 °C maximum operating temperature
- 132 single ramp PID controller & separate temperature display to 1.0 °C resolution
- A UKAS traceable calibration certificate for customer defined setpoints is available
- A UKAS calibrated thermocouple is available

www.carbolite-gero.com/products/application-specific-furnaces/thermocouple-calibration/ptc-thermocouple-calibration-furnaces/function-features/



CF – Cupellation Furnaces

The CF cupellation furnaces are designed for the cupellation, or fire assay test, of precious metals, which is a standard test method used to determine their purity.

The furnaces meet the Hallmarking requirements specified by the Convention on the Control and Marking of Articles of Precious Metals (known also as "Precious Metals Convention", "Hallmarking Convention" or "Vienna Convention").

The test method produces hazardous vapours. When used within a suitable fume management system, the cupellation furnaces are designed to handle the vapours without exposing the operator to these hazards. The design of the cupellation furnace range ensures protection from the corrosive environment which would damage a conventional furnace.

Carbolite Gero also offers a range of smelting/melting furnaces (please enquire).

Standard features

- 1200 °C maximum operating temperature
- Carbolite Gero 301 controller with single ramp to setpoint & process timer
- Designed for testing using the cupellation method to ISO11426:1999 the standard test method used by the UK Assay Office, a reference quantitative assay method by the International Hallmark Convention
- The airflow, controlled by an adjustable valve, is preheated before entering the work chamber
- Silicon carbide elements mounted above & below the chamber provide even heating of cupels, have good resistance to thermal shock and offer extended working life at high temperatures
- Silicon carbide lined roof and hearth protect the heating elements and resist the corrosive fumes emitted during the cupellation process
- Fumes are extracted through an insulated exhaust duct, with a removable container to collect condensed lead
- Counterbalanced vertical lift door fitted with observation hole
- Element over-temperature protection controller
- Fitted with 7 day, 24 hour time-switch



CF 24B

Options (specify these at time of order)

- A range of sophisticated digital controllers, multi-segment programmers and data loggers is available. These can be fitted with RS232, RS485 or Ethernet communications (see page 100)
- Over-temperature protection (recommended to protect valuable contents & for unattended operation)

Technical data

CGH	Max. temp. [°C]	Maximum continuous operating temp. [°C]	Dimensions: Internal H x W x D [mm]	Dimensions: External H x W x D [mm]	Dimensions: External with door open H x W x D [mm]	Charge capacity of no. 8 cupels	Charge capacity of no. 6 cupels	Thermocouple type	Max. power [W]
CF 15B	1200	1200	125 x 215 x 270	1055 x 910 x 930* 225 x 600 x 380 (Separate control module)	900 x 910 x 1130*	15	24	R	9000
CF 24B	1200	1200	200 x 250 x 340	2100 x 940 x 1020**	1920 x 940 x 1180**	24	32	R	13000
CF 60B	1200	1200	250 x 400 x 600	2300 x 1190 x 1240**	2000 x 1190 x 1580**	60	90	R	31000

i Please note:
* Bench-mounted, ** Floor-standing

AZ – 8-Zone Tube Furnaces

The AZ is an eight zone tube furnace for controlled temperature profiles. These zones can be used to generate temperature profiles along the heated length of the furnace.

With eight zones, thick insulation, and highly symmetrical winding of the heating elements throughout the entire AZ furnace, a uniformity of better than $\pm 5^\circ\text{C}$ is achieved. A key advantage of the eight individually controlled zones is the extension of the uniform length inside the furnace.

Standard features

- Eight-zone control for variable heating profiles
- Gradients, linear increase/decrease etc. of temperature along the heated length
- Extended uniform temperature distribution
- Short heating and cooling rates
- Automatic operation



AZ 13/110/1000: This picture shows the high vacuum equipment and touch panel controller option



MTT – Carbon-14 and Tritium Furnaces

This apparatus uses catalyst assisted combustion techniques to give a clean and precise approach to extracting carbon-14 & organically bound tritium or 'fixed tritium', e.g. tritium contained in concretes, steels and graphites, as well as 'free water'.

A catalyst is used to ensure complete combustion of all thermal decomposition products. These are captured for liquid scintillation assay. This technique gives greater confidence of complete combustion than 'wet oxidation' techniques and avoids coloured contamination of scintillation media by botanical samples.



MTT 12/38/850



Standard features

- 1200 °C maximum operating temperature
- 3508P1 20 segment programmable temperature control for sample specific combustion protocols
- 2-zone tube furnace configured for capture by combustion of organically bound carbon-14 and tritium
- Large sample capacity up to 20 ml provides accurate determinations
- Originally developed in partnership with AEA Technology
- 2 quartz glass work tube assemblies
- 6 combustion boats
- Three sets of glass gas bubblers (12 in total)
- All connectors including the molecular sieve waste aerosol trap
- Unique catalyst optimisation manifold
- 6 copper wire catalysts
- Over-temperature protection of both heated zones
- RS485 communications & control
- Eurotherm iTools allows software storage & recall of specific sample protocols
- Free from plastic or rubber components into which tritium can migrate
- A comprehensive process instruction manual

Vacuum, Inert and Reactive Gas Furnaces up to 3000 °C

LHTG, LHTM, LHTW top loader vacuum chamber furnace up to 3000 °C

The vacuum chamber furnace range LHTG, LHTM, LHTW furnaces (using Graphite, Molybdenum or Tungsten as heating and insulation material) are typical laboratory furnaces designed for all types of heat treatment processes (eg in material science). They are used for high vacuum applications up to 1×10^{-6} mbar and very pure atmospheres of hydrogen and other gases. The graphite versions have a maximum operating temperature of 2200 °C, but versions up to 3000 °C can be supplied. All furnaces are available with manual operation as standard but also can be supplied with fully automated control by a SIEMENS PLC with WIN CC visualisation.

www.carbolite-gero.com/products/vacuum-furnace/laboratory-furnaces/



LHTW 200-300/22



HTK front loader vacuum chamber furnace up to 3000 °C

The HTK range is available in three different versions (Molybdenum, Tungsten or Graphite) and in up to six different sizes. The smallest designs with 8 litre and 25 litre capacity are usually employed by laboratories for research and development. The 80 litre to 600 litre capacity versions are predominantly used as plant for pilot manufacture and for production. Typical applications include pyrolysis, siliconizing and graphitizing, metal powder injection moulding, tempering of sapphires, sintering of pellets in the nuclear industry, manufacture of radar tubes, metallisation of ceramic components and high vacuum brazing.

www.carbolite-gero.com/products/vacuum-furnace/chamber-furnaces/



HTK 400 GR/22



Metal- and ceramic Injection Moulding (CIM and MIM) and Debinding and Sintering Furnaces

High volume production of complex metal parts is increasingly carried out by metal injection moulding. During this process a metal/binder mixture is injected into molds. These, so called green parts, need to be and finally sintered to obtain the desired mechanical properties. For this purpose Carbolite Gero offers optimized products for debinding and sintering like the EBO (optimized for BASF Catamold® feedstock) and the HTK range.

www.carbolite-gero.com/mim



HTK 120 MO/14
for partial
pressure sintering

EBO 120/1.5 for
catalytic debinding



Custom Designed Ovens & Furnaces up to 3000 °C

Carbolite Gero can provide custom solutions for all products up to 3000 °C by modification of a standard product or custom designing a product to provide a customer specific process solution.

Vacuum, Inert & Reactive Gas Furnaces up to 3000 °C

With the formation of Carbolite Gero, customers requiring heat treatment processes from 30 °C to 3000 °C have access to a single highly qualified source for equipment. Carbolite Gero instruments work with vacuum, partial pressure, air, controlled pressure and overpressure environments.



Download the catalogue now!



Custom Designed Ovens & Furnaces up to 1800 °C

GP 450A general purpose oven with rotating mechanism

This is a good example of a mechanical modification of a standard product. In this case the customer required continuous agitation of their samples. The samples are simply clipped onto the fixtures which rotate once the oven door is closed. The fixtures can be rotated slowly with a manual push button to the correct positions to load the samples.

- Testing corrosion inhibitors used in the petroleum industry between 60 and 120 °C
- Rotating mechanism to accept 20 of the customer's reactors on two shafts, directly driven via motor and gearbox
- Independent adjustable rotation speed in the range 1 to 10 revolutions per minute.
- Door closing mechanism using shoot bolt with interlock to stop rotation of mechanism when the door is open

www.carbolite-gero.com/products/custom-furnaces-ovens/



GP 450A

Top hat furnace system with twin retorts

This complete top hat system has two vertical tubular Inconel 601 retorts with a furnace that can heat one retort whilst the other is being prepared or is cooling. The furnace has a parking position when not in use. The system is supplied with a gas safety system to allow the use of hydrogen and can also be used under vacuum.

- Machined retort base plate for vacuum sealing against a water cooled hearth base with twin elastomer seals
- Hydrogen flow interlocked to gas safety system requirements: furnace temperature; minimum flow rates; gas supply pressures; and pre-timed nitrogen purge; gas burn off with flame failure system
- Three heated zones of 200 mm with 25 mm thick insulated zone barriers

www.carbolite-gero.com/products/custom-furnaces-ovens/



Top hat furnace system with twin retorts

Cycling corrosion test furnace with gas system

This is an excellent example of a system which combines a tube furnace, gas control equipment and mechanical modifications. The tube furnace and its integral extraction hood are mounted on wheels and can be moved along the quartz work tube. The rails for the wheels are mounted on the support frame. Mass flow controlled gas supplies are fed into the work tube through end seals together with probe thermocouples. It is used for long term corrosion testing of turbine blades.

- Siemens TP 177B HMI colour touch screen control system with temperature display, gas control and alarm display
- Gas control through mass flow controllers connected to the Siemens control system with flow range 0 to 10 litres per minute
- Mixed gases pass through a humidifier with a maximum flow rate of 4 litres per minute. Deionised water supply required
- Hydrogen and carbon monoxide flow interlocked to furnace temperatures above 750 °C.
- Heavy gauge APM wire heating element cassette suitable for 1300 °C operation

www.carbolite-gero.com/products/custom-furnaces-ovens/



Bespoke cycling corrosion test furnace

Product Configurations

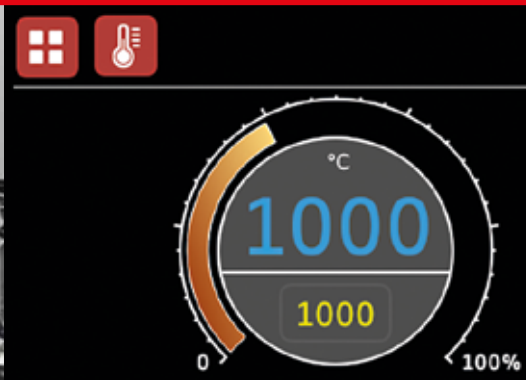
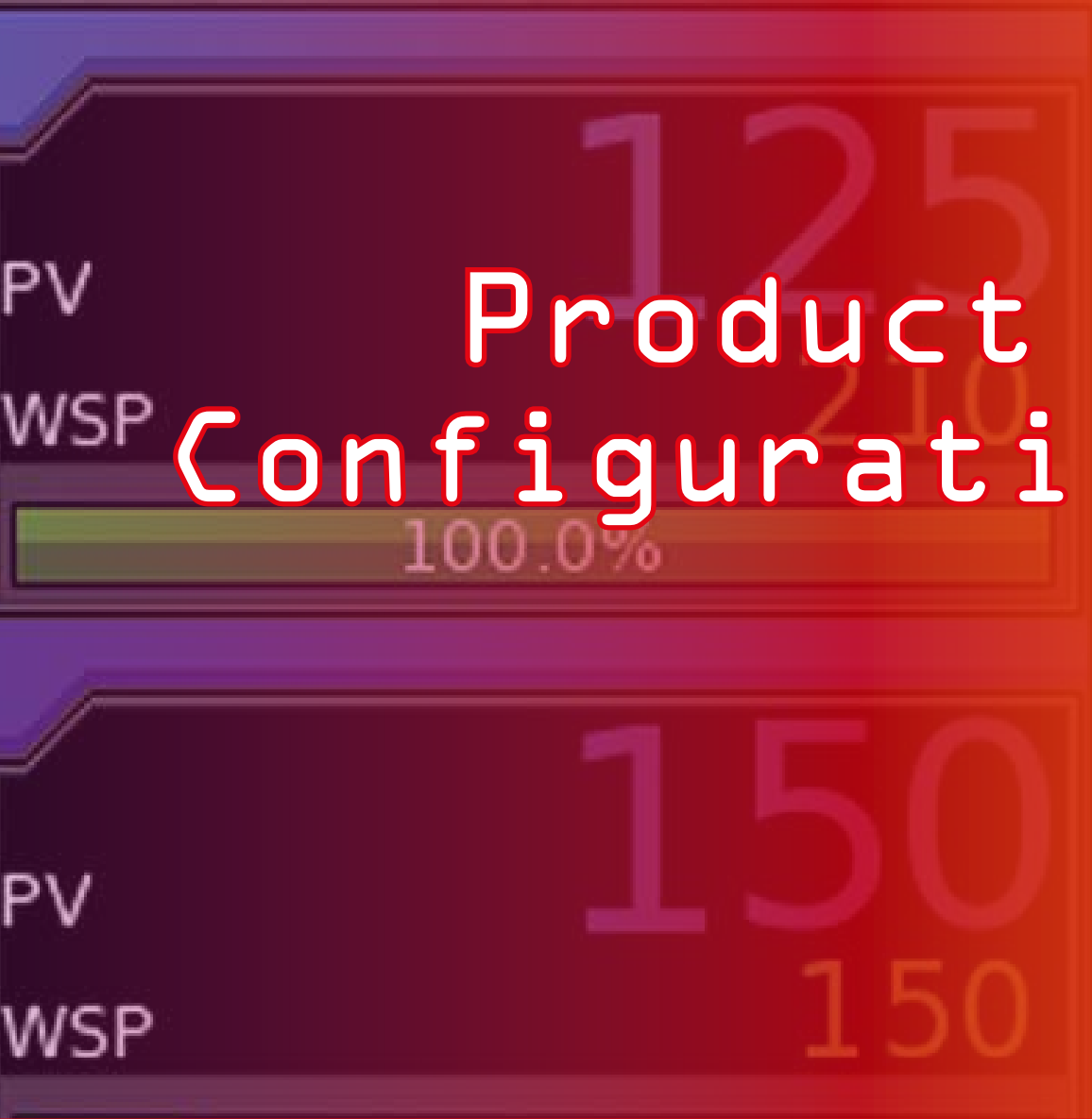

nanodac

Product Configurations	Page
Temperature Control Options	100
Work Tube Selection Guide	106
Work Tube Packages	107
Work Tube Accessories	110
Vacuum Pump Packages for Tube Furnaces	112
Modified Atmosphere Options	113
Accessories	118
Power Supply Information	120

The range of high quality PID (Proportional, Integral, Derivative) temperature controllers shown below are fitted to Carbolite Gero products. These controllers provide accurate temperature control that closely follows programmed ramp rates and setpoint temperatures. The full range is not fitted to all products, please see product pages for details.

NEW Touch Screen Controller

CC-T1 touch screen controller

The CC-T1 touch screen controllers offer programmable control in which 24 segments may be set as ramp, step or dwell and may also be configured to control relays.

The CC-T1 series provides a touch screen interface giving intuitive access to a comprehensive menu including: selection and editing of program profiles; scheduling of programs at a defined date/time; data logging of setpoint and actual temperature; localization of language; user level security. The CC-T1 series can also store and retrieve 10 unique program profiles. Data-logging is to a csv file which is accessed through the adjacent USB port. Ethernet communication is fitted as a standard feature.

When specified with a 3-zone product the control method is user selectable to be either retransmission of setpoint or independent control. With retransmission of setpoint the main zone controller's setpoint is automatically applied to the other zones. When running a program all zones will follow the program profile. With independent control each zones setpoint is set manually.

Standard features

- 4.3" colour touch screen
- Setpoint control
- Program profile control
- 10 unique program profiles saved in memory
- 24 segments per unique program
- Ethernet communication
- Panel mounted USB socket
- Data logging to a USB memory stick in a .csv file format
- Real time clock
- Program schedule start
- Program status indication with estimate end time & date
- Event indication (2 events)
- Control power indication
- User level security
- Dual temperature calibration
- Language setting: English, German, French, Italian, Spanish, Chinese, Russian, Japanese
- 3-zone version: retransmission of setpoint



The new CC-T1 touch screen controller in use.

Options (specify these at time of order)

- Over-temperature protection (independent controller)
- Alarm activation of relays to operate devices such as a door interlock
- Program segment events
- Temperature alarm relay connections
- Cascade control
- Ethernet to USB adapter. To connect one product direct to a computer
- Ethernet firewall router with DHCP capability. To connect one product to an Ethernet network

User level functionality

User level	Functions
Operator	Change temperature setpoint • Run pre-configured programs • Run data logging
Supervisor	All of the above plus: • Configure and edit programs • Manage alarms
Administrator	All of the above plus: • Set language, time and date • Edit data logging settings • Edit settings including calibration and serial communication

Navigation screen

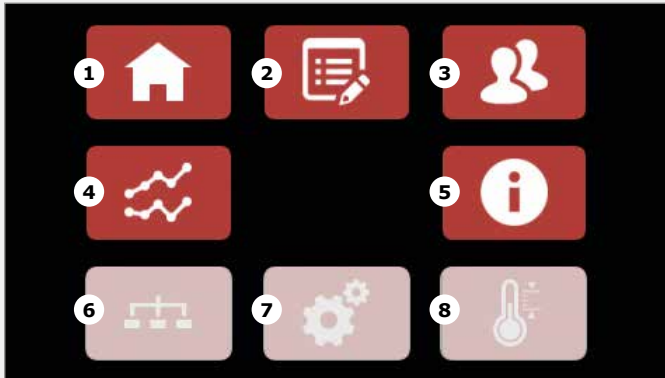

The navigation screen gives easy access to all the CC-T1 functions.

- 1) Home
- 2) Program view
- 3) User login
- 4) Data logging
- 5) Information
- 6) Communication settings
- 7) Settings
- 8) Offset calibration

Home screen single zone

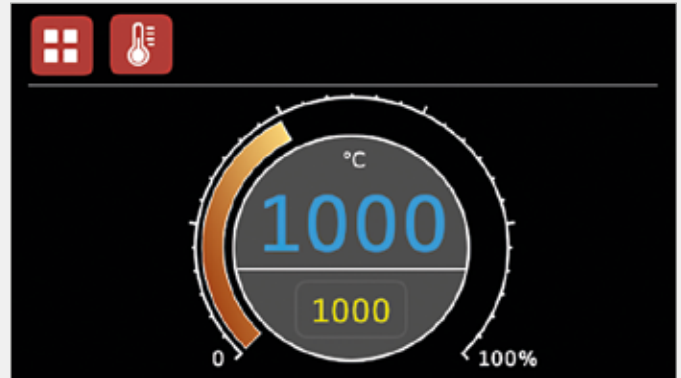

The home screen shows the setpoint, actual temperature and the heating power.

Home screen program running

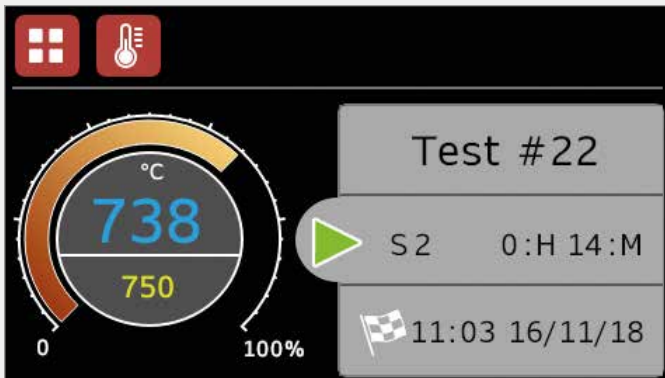

When a program is running the home screen shows a summary of the progress of the program. This includes: the program name; the current program segment and the time remaining in that segment; the end time and date of the program

Home screen 3-zone

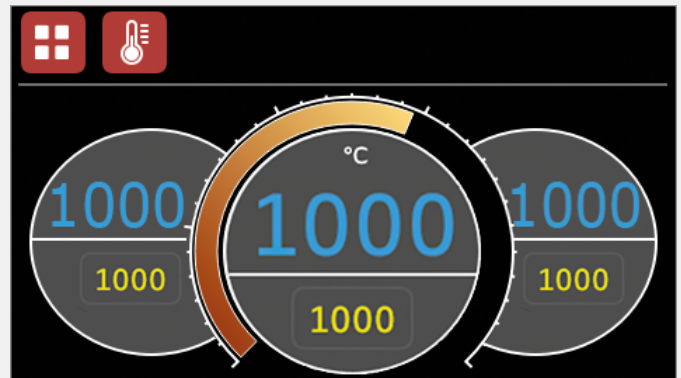

For a 3-zone product the home screen shows the setpoint and actual temperature of each zone. The user can select the end zones to either follow the centre zone temperature or run independently.

Program view screen

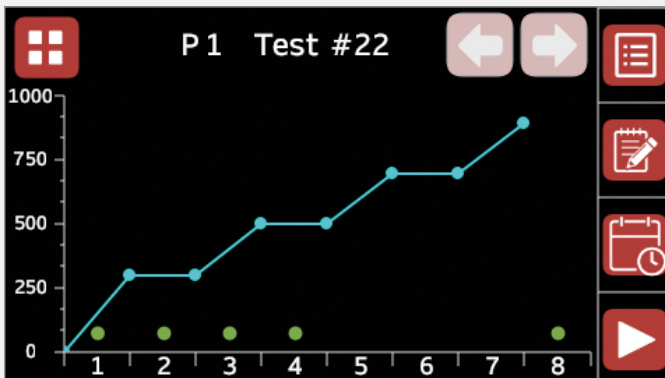

The program view screen shows a graphical summary of the selected program. It also give access to: Program selection; program creation and editing; scheduling a program to run at a specific time and date and running a program.

Data Logging Screen

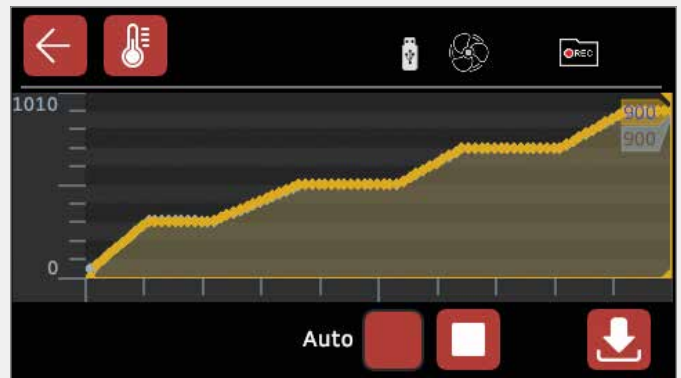

The data logging screen shows a graphical view of the setpoint and actual temperature along with the status of any configured relays. Data is logged to a USB stick in a .csv file format. Data logging can be started manually or automatically when a program is run.

New EPC3016 & EPC 3008

EPC3016P1

Programmable temperature controller

- 1 program with 24 segments
- Ramp, dwell, step, call, end segments
- 2 x relay
- Ethernet communication fitted
- certified for cybersecurity communications robustness

This controller offers programmable control in which 24 segments may be set as ramp, step or dwell and may also be configured to control relays. Ethernet communication is fitted as standard. If precise temperature control is required over a wide range of temperatures, the EPC3016P1 allows the use of multiple PID terms (gain scheduling). This feature is not enabled as standard, but can be activated on request.



EPC3008P10

Programmable temperature controller

- 10 program with 24 segments
- Ramp, dwell, step, call, end segments
- 3 x relays
- Ethernet communication fitted
- certified for cybersecurity communications robustness

This controller offers programmable control in which 24 segments may be set as ramp, step or dwell and may also be configured to control relays. Ethernet communication is fitted as standard. The EPC3008P10 provides a comprehensive information display. If precise temperature control is required over a wide range of temperatures, the EPC3008P10 allows the use of multiple PID terms (gain scheduling). This feature is not enabled as standard, but can be activated on request. The EPC3008P10 can also store and retrieve 10 programs.



Temperature controller features and options

Temperature controller model	EPC3016P1	EPC3008P10	CC-T1	nanodac
------------------------------	-----------	------------	-------	---------

Furnace control

Number of programs	1	10	10	100
Number of segments per program	24	24	24	25
Relay operated options (e.g. solenoid valve, cooling fan, door lock, etc.) maximum	2	3	2	3
Cascade control	No	Optional	Optional	Optional
Auto tune	Yes	Yes	Yes	Yes

User interface

Screen Resolution	4 digits + 16 segment scrolling text	4.5 digits + 5 character 16 segment text + 16 segment scrolling text	TFT colour LCD 480 x 272 pixels	TFT colour LCD 320 x 240 pixels
Screen size (inch)	1.6"	2.5"	4.3"	3.5"
Interface	4 buttons	4 buttons	Touchscreen	4 buttons
Start time configurable (e.g. to use night power rates)	No	No	Yes	Optional
Real-time clock with calendar	No	No	Yes	Yes
Data logging of process data with USB-flash drive	No	No	Yes	Yes
Data logging to secure file	No	No	No	Yes
Programming and data logging software	Optional	Optional	Optional	Optional
User levels	Yes	Yes	Yes	Yes
Program names displayed	Program number	Program number	Individual program name	Individual program name
Choice of languages	5	5	8	5

Communications

Ethernet communication connection	Yes	Yes	Yes	Yes
Certified for cybersecurity communication robustness	Yes	Yes	Yes	Yes
USB connection (for data export)	No	No	Yes	Yes

Eurotherm Nanodac™

Recorder & PID controller

In this configuration the nanodac™ combines precision PID temperature control, with a fully functional data logger. The full colour display can be changed to display text in English, French, German, Italian or Spanish. Data is continuously logged into either CSV (comma separated variable) or securely to UHH (Eurotherm Hydra History) files. Data can be archived onto a USB flash drive or via Ethernet to a networked server. Up to 4 channels can be recorded, with up to 14 virtual channels that can be set to record trends, alarms, communications or mathematical functions such as totals or averages. Logged files can be opened and displayed on a PC, in chart form, using Eurotherm Review Lite software.

Recorder & PID programmable controller

In addition to the above this controller offers programmable control in which 25 segments may be set as a ramp, step or dwell and may also be configured to control relay outputs. It stores and retrieves 100 programs. Additional programs can be saved to, and retrieved from, a network server via a USB flash drive or Ethernet. The action of up to 3 relays can be linked to a program segment; this can be used to switch on external devices such as gas solenoid valves and audible alarms. Note that some configurations may require additional components.

Eurotherm nanodac™ DAQ recorder only

In this configuration the nanodac™ can be used in combination with a conventional controller as a paperless chart recorder. Data is continuously logged into either CSV (comma separated variable) or secure UHH (Eurotherm Hydra History) files. Data can be archived onto a USB flash drive or via Ethernet to a networked server. Up to 4 channels can be recorded, with up to 14 virtual channels that can be set to record trends, alarms, communications, or mathematical functions such as totals or averages. Logged files can be opened and displayed on a PC, in chart form, using Eurotherm Review Lite software.



In this configuration the nanodac™ can hold up to 100 programs

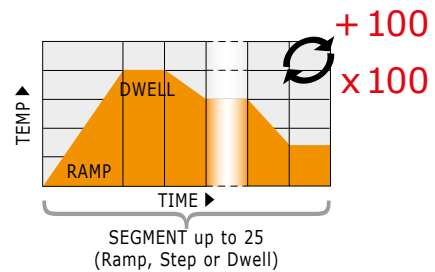

Batch recording option

Batch records form a part of recording history and are identified by messages that are written to the history file indicating when a batch starts and ends, along with additional customisable textual information. Batches can be initiated directly by the operator, automatically whenever a specific PV value is reached, or remotely via Modbus.

Ethernet Communication

- Ethernet communication fitted as standard where the controller is CC-T1, EPC3016P1, EPC3008P10 and nanodac
- Requires, but does not include, suitable PC based software (eg iTools) and connection cables
- Ethernet to USB converters are available

The CC-T1 has fixed IP addresses and needs to be connected to a network using the Ethernet firewall router or the Ethernet to USB converter

Ethernet Router

- A pre-configured Ethernet Router Firewall for connection of a CC-T1 controller to a users Ethernet Network
- The product connected is identified by its serial number



Standard Controller

301 Standard controller

The 301 PID controller has a large display mounted behind a smooth wipe-clean membrane and offers a single ramp to set point. It includes a 99 hour process timer which can be programmed for a timed delay at the start of the process or used as a countdown timer.



The 301 provides precise PID (Proportional Integral Derivative) control meaning that ramp rates and set points are very closely followed.

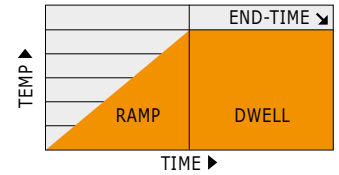

132 PID controller

Where size limitations don't allow the 301 controller to be fitted, the 132 is fitted instead. Features a single ramp to setpoint and process timer, which can be programmed for a timed delay at the start of the process or used as a countdown timer.



Options

301 Over-temperature control

This option offers a variable set point to protect either the chamber or the load. Selection of this option provides an additional independent thermocouple and protection circuit which is fully integrated into the 301 controller. Whilst all Carbolite Gero products are designed to fail safe in the event strongly recommended for unattended operation or where valuable loads are to be processed.



R38 Standard controller

The R38 is a simple PID oven controller with a large digital display. The R38 will accurately maintain the set point temperature.



iTools software

A versatile suite of software that allows Carbolite Gero products that have been fitted with appropriate digital communications hardware to be set-up, recorded and monitored from a PC. The supplied licence is for a single PC to communicate with one furnace using RS232 or with many furnaces using RS485. **NOTE:** The 301 controller is not compatible with RS485 communications.

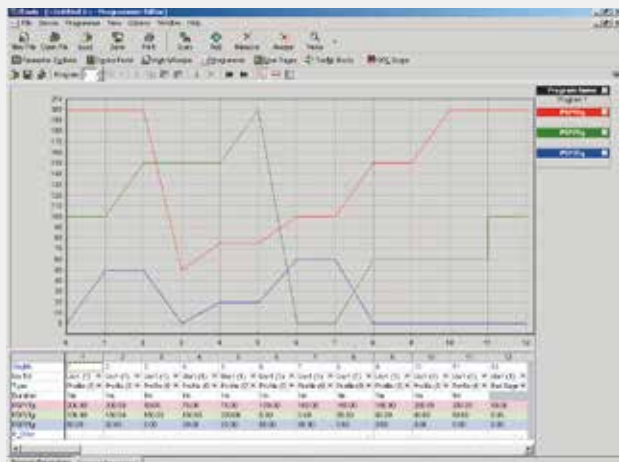

Over-temperature control option

This has a variable set point to protect either the furnace, oven or the load. If the main controller is a EPC3016P1, EPC3008P10 or nanodac™ this is provided by the addition of an independent controller. Whilst all Carbolite Gero products are designed to fail safe in the event of a controller malfunction, overtemperature protection is strongly recommended for unattended operation or where valuable loads are to be processed.



Cascade Control

This feature offers the benefit of precise temperature control of the load. A standard controller operates by sensing the temperature close to the elements. With cascade control the controller's operation includes a second control thermocouple, which is used to sense the temperature of the load. It is essential that the controller is a CC-T1, dual loop EPC3008P10 or dual loop nanodac™.

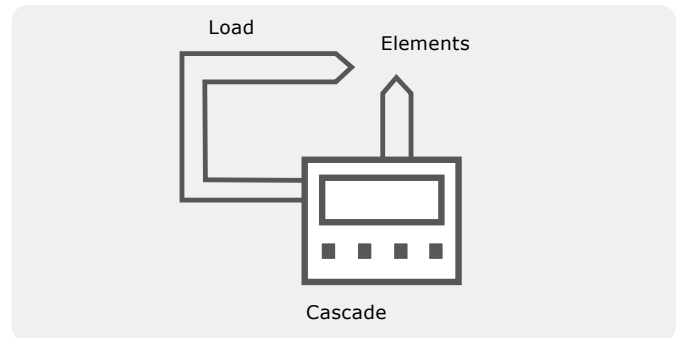

Three Zone Control

This has the function in 3-zone tube furnaces of extending the length of the uniform heated zone.

Retransmission of set point

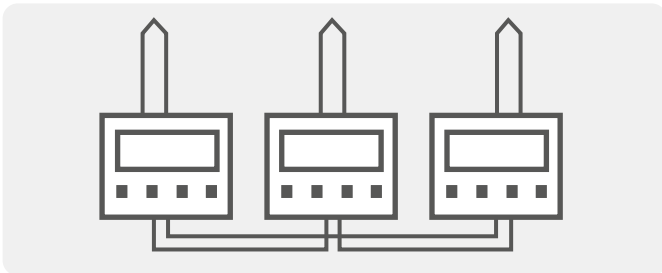

This is the standard method of control for all Carbolite Gero 3-zone furnaces. When the operator adjusts the setpoint of the centre zone controller, the setpoint of both end zones are automatically set to the same value. When a program is run in the centre zone all zones will automatically follow the program. Each controller has one thermocouple positioned with the tip close to the centre of each zone.

Independent control

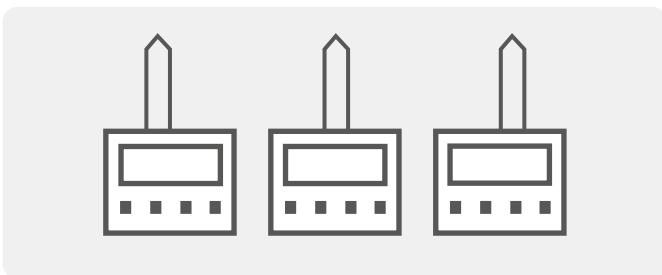

This configuration comprises independent controllers, each with an independent thermocouple in its respective zone. This is the standard method for the TG gradient tube furnaces.

Three zone cascade control

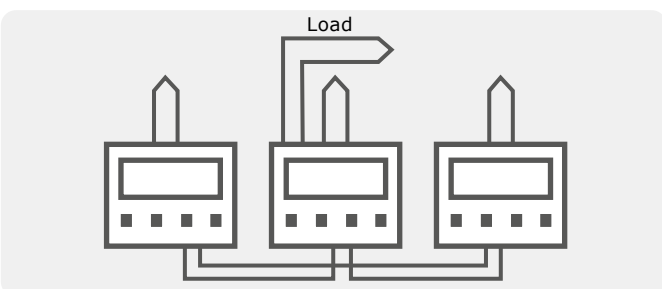

As in single zone furnaces, cascade control allows faster heating of the furnace load and more precise control of the load temperature. A CC-T1, EPC3008P10 or nanodac™ controller is required.

Work Tube Selection Guide

The material, length and diameter of the work tube required for use with each furnace differs. The appropriate material work tube for each furnace can be selected from the tables below. Work tube length depends on whether the furnace will be used to work in air or with modified atmosphere/vacuum.

Tube material	Physical & chemical properties			Maximum temperatures [°C]		
	Porous / Impervious	Resistance to thermal shock is partly dependent upon specific tube dimensions	Chemical resistance	in air		under vacuum pressure
				Horizontal	Vertical	Horizontal and Vertical
Sillimanite (Al ₂ SiO ₅)	Porous	Good	Good chemical resistance but porous	1500	1600	-
Mullite C610 / IAP (Impervious aluminous porcelain) (3Al ₂ O ₃ , 2SiO ₂)	Impervious	Very good	Good chemical resistance against gases, with the exception of fluorine. Resistant to flux sulphurous or carbonaceous atmospheres	1450	1550	1350
RCA C799 (Recrystallised alumina)	Impervious	Good	Highly resistant to chemical attack, with the exception of fluorine	1800	1900	1500 (Ø 75 mm)
						1450 (Ø > 75 to 88 mm)
Quartz	Impervious	Excellent	Generally good but reactive with sodium & at upper temperature limit with metals, carbonates & halides	1150	1200	1150
APM (Advanced powder metallurgy - FeCrAl)	Impervious	Excellent	Resistant to oxidation, carburization & sulphidation	1300	1350	1200
NiCr alloy (Inconel)	Impervious	Excellent	Good high temperature oxidation resistance combined with good resistance in carburising and chloride containing environments	1100	1100	750
High temperature stainless steel 1.4841 (314)	Impervious	Excellent	Good oxidation resistance	1100	1100	600

i Please note:

- Long unsupported horizontal work tubes will bend at high temperatures

Calibration certificates

The following calibration options can be supplied, each of which is available with a certificate from a UKAS accredited laboratory, which is traceable to a UK national standard

- UKAS traceable certificate for the thermocouple only, calibrated at 3 temperature points, specified by the customer
- UKAS traceable certificate for the temperature controller only, calibrated at 3 temperature points at temperatures specified by Carbolite Gero

- UKAS traceable certificate at 3 temperature points for both thermocouple & temperature controller
- For advice and specifications to comply with AMS2750F (Nadcap) for heat treatment applications, please contact Carbolite Gero

Work Tube Packages

Air, gas atmosphere and vacuum work tube packages for TF, TS & TG tube furnaces

Work tube packages are listed in the optional accessories section of each tube furnace, with the intention of providing a 'quick ordering' system for combining the accessories required for the specified application. Each package comprises a work tube of the specified diameter with insulation plugs or heat shields appropriate for the operating atmosphere. A pair of end seals is included in the gas atmosphere and vacuum packages. A 3 mm diameter thermocouple gland with blanking plug is included in one end of all work tube packages for furnaces up to 1200 °C. Above 1200 °C one end seal will have a 10 mm diameter thermocouple gland with blanking plug to suit a probe thermocouple (probe thermocouple must be ordered separately).



Work tube packages with extended length work tubes include guards as indicated in this image. The guards simply hook into the end plates of the tube furnaces and are each fixed with one screw.

The work tube material in the packages are:

- For TF, TS & TG 1200 °C furnaces there is a choice of mullite C610 / IAP or quartz.
- For TF 1600 °C furnaces there is a choice of RCA or mullite C610 / IAP.
- For F-range 1350 °C furnaces there is a choice of mullite or APM.
- For HTRH & HTRV 1800 °C furnaces RCA tubes are used.

See work tube selection guide on page 106 for maximum temperature limits.

Alternatives to these packages can be created by selecting appropriate individual components.

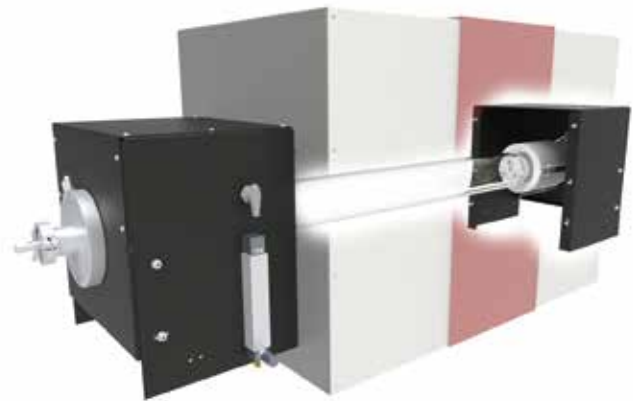

Attachment housings can be secured to the furnace for convenient vacuum / protective gas operation.

Technical data

Work tube package	Type of package	Atmosphere				Type of end seals	Type of end insulation	leakage rate [mbar l/s]
		Air	Inert gas	Vacuum	Hydrogen			
1	Work tube package for air	Yes	No	No	No	None	Plug	-
2	Gas Atmospheres	Yes	Yes	No	Only with gas safety system p. 114 (LGSS)	6 mm gas inlet/outlet	Plug	<5x10E-2
3	Vacuum and inert gas	Yes	Yes	Yes	Only with gas safety system p. 114 (LGSS)	NW vacuum flanges	Radiation shield	<5x10E-2
4	Comprehensive vacuum and inert gas package	Yes	Yes	Yes	Only with gas safety system p. 115	Water-cooled NW vacuum flanges	Radiation shield	<5x10E-3

Work tube package 1 for air

Tube furnace work tube package for air contains:

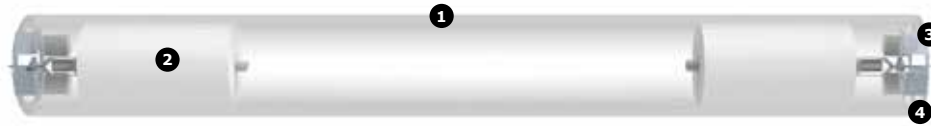

- 1) Standard length work tube
- 2) 2 x insulation plugs for standard length work tube
- 3) Support bracket for insulation plugs & thermocouple
- 4) Probe thermocouple access:
 - a) Up to 1200 °C:
Diameter 3 mm gland to suit optional type N probe thermocouple
 - b) Above 1200 °C:
10 mm gland with PTFE seal and blanking plug to suit optional type R or B or 20/40 probe thermocouple assembly

Available for all tube furnaces

Work tube package 2 for gas atmosphere

The work tube package for gas atmosphere is suitable for either inert gas or hydrogen atmosphere. If use with hydrogen a gas safety system **MUST** be used (see page 114).

Tube furnace work tube package for gas atmosphere contains:

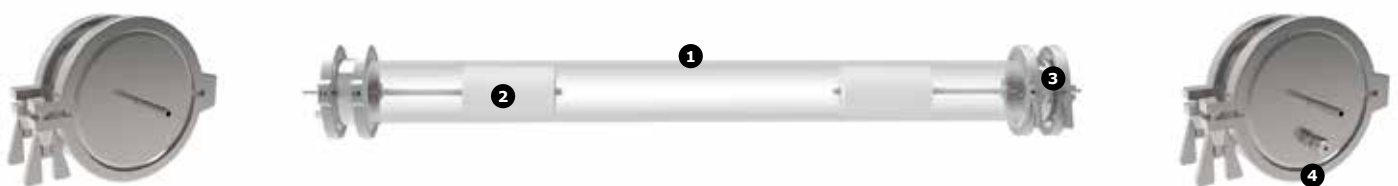

- 1) Extended length work tube
- 2) 2 x insulation plugs for extended length work tube
- 3) Work tube end seals:
 - 1 x gas inlet/outlet pipe
 - 1 x gas inlet/outlet pipe + thermocouple gland
- 4) Probe thermocouple access:
 - a) Up to 1200 °C:
Diameter 3 mm gland and blanking plug to suit optional type N probe thermocouple
 - b) Above 1200 °C:
10 mm gland with PTFE seal and blanking plug to suit optional type R or B or 20/40 probe thermocouple assembly

Available for all tube furnaces

NOTE: For hydrogen atmosphere a gas safety system **MUST** be used (see page 114).

Work tube package 3 for vacuum and inert gas

Available for work tube outer diameters 60, 86, 125, 150, 200 mm.

Tube furnace work tube package for vacuum atmosphere is suitable for vacuum pressure to 5×10^{-2} mbar or 1×10^{-5} mbar depending on type of vacuum pump used (page 112) and contains:

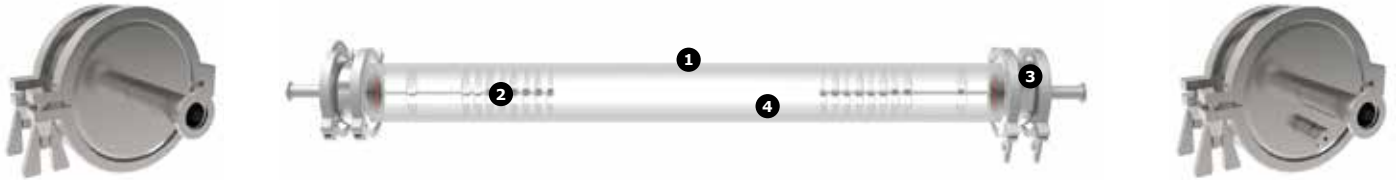

- 1) Extended length work tube
- 2) 2 x radiation shields
- 3) Work tube end seals:
 - 1 x NW16 vacuum flange + thermocouple gland
 - 2 x end plates: 1 x NW25 (compatible with low vacuum pump package); 1 x NW40 for 60 mm work tube outer diameter or 1 x ISO-K 63 for 86, 125, 150 & 200 mm work tube outer diameters (compatible with high vacuum pump package)
- 4) Probe thermocouple access:
 - a) Up to 1200 °C:
Diameter 3 mm gland and blanking plug to suit optional type N probe thermocouple
 - b) Above 1200 °C:
10 mm gland with PTFE seal and blanking plug to suit optional type R or B or 20/40 probe thermocouple assembly

Available for all tube furnaces

Work Tube Package 4 vacuum applications with low leakage and inert gas atmosphere

The package also includes furnace mounted flange holders. The vertical versions include a stand and differ slightly.



- 1) Overflow valve
- 2) Water cooled flange requires 2-4 l/min cooling water
- 3) Fibre wool blankets
- 4) Radiation shields
- 5) Gas outlet with hand valve
- 6) Extended length work tube
- 7) Gas inlet / 6 mm compression fitting
- 8) Flow controller mounted in the frame

Available for FHA, FHC, FST, FZS, HTRH, HTRV, HTRV-A

NOTE: Models up to 1350 °C. No radiation shields included in the package. They have to be ordered **SEPARATELY**.

To ensure the correct accessories are supplied, please specify the furnace model (horizontal or vertical use), work tube dimensions (inner diameter, outer diameter and length) and operating temperature.

Ceramic insulation plugs

Ceramic insulation plugs are designed to reduce heat loss from tube ends and improve temperature uniformity. They are particularly helpful for vertical tubes and tubes with diameters greater than 25 mm. Different insulation plugs are supplied for use with standard length work tubes (for use in air) and extended length work tubes (for use with modified atmosphere and vacuum). In vertical work tubes, insulation plug supports are required unless used with work tube end seals (see below). Insulation plugs include metallic hangers which allow vertical use and a groove for thermocouple access.

The insulation plugs supplied will be appropriate for the furnace and application.



Insulation plug

Radiation shields

In extended work tubes radiation shields can be used as an alternative to insulation plugs. Specifically useful for dust free applications and with vacuum levels lower than 10^{-3} mbar. Up to a maximum operating temperature of 1200 °C the shields are constructed from metal, and above this temperature from ceramic. In vertical work tubes, radiation shield supports are required unless used with work tube end seals (see below).

Radiation shields include metallic hangers which allow vertical use and a groove for thermocouple access.

The shields supplied will be appropriate for the furnace and application.



Radiation shield

Work tube end seals

Work tube end seals are required to contain a modified atmosphere and for working with vacuum; vacuum levels of 10^{-6} mbar are possible. These end seals are manufactured from stainless steel and are for use with extended work tubes only. They are available to fit work tubes with the following outside diameters: 32, 46, 60, 86, 100, 150 and 200 mm. Other sizes are available at additional cost.



End seal with gas nozzle (inlet/outlet)



End seal with NW40 vacuum flange



End seal with gas nozzle and thermocouple gland (1.5 mm)

The following fittings are available for use with the end seals: blank seal, gas nozzle (inlet/outlet), vacuum flanges (NW16, NW25, NW40 or ISO-K 63) and thermocouple glands (ø1.5 mm, 3 mm and 10 mm). Where the end seal diameter is large enough, combinations of the above fittings are possible, e.g. gas inlet/out nozzle + thermocouple gland. The end seals are designed for use in combination with insulation plugs or radiation shields. Water cooled end seals are available on request. To accommodate the additional weight of end seals, tube supports are included in the work tube packages.

End seal detail for work tube packages 1 to 3

- 1) Clamp
- 2) Seal plate
- 3) 'O' ring seal
- 4) Seal sleeve
- 5) Clamp seal
- 6) End plate

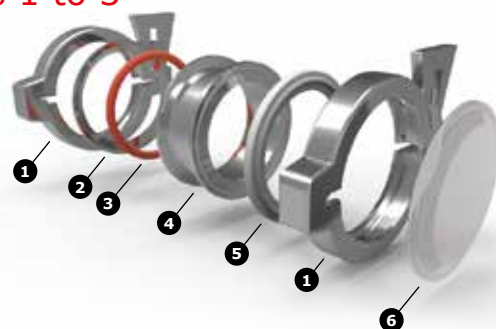

Water cooled end seal for work tube package 4

- 1) Hose nozzle
- 2) Flange ring with water cooling
- 3) O-ring
- 4) Flange cover with water cooling and Small flange KF
- 5) Screws

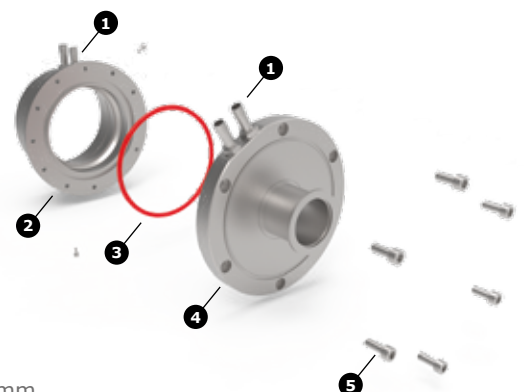

NOTE: The acceptable tolerance of the work tube outside diameter is +1.5 mm to -1 mm

Accessories for Operation under Vacuum and Process Gas

For applications under vacuum or process gas, a comprehensive range of accessories is available for the F range, HTRH and HTRV tube furnaces. Tightly sealed, high purity Al_2O_3 and Al_2O_3 / SiO_2 tube materials, water cooled stainless steel flanges, and gas supply equipment allow for thermal treatment under specified atmospheres. In such treatment processes, the gas flow can be controlled either manually, with use of a flow meter, or automatically, with the use of a mass flow controller. Complete vacuum pumping systems, rotary vane pumps, turbomolecular pumps, data recording systems, and visualization software complete the product range.



Upon request, tube furnaces of the F range, HTRH and HTRV can be supplied with a robustly welded frame with or without castors and control cabinet.



As some furnaces can be used horizontally as well as vertically, an extra stand is available that is specifically designed to guarantee a safe working environment in any position.



Vacuum pumps or complete pumping systems with the appropriate measuring technology.



Equipment flanges can be furnished with fast clamping seals.



Water cooled stainless steel flange



Radiation protection packaging

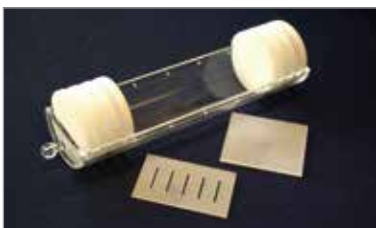

In response to customer demand, sample carriers for wafers or sample attachments of various materials are available.



For loading samples, sample boats and crucibles are available in various sizes and materials.



With automated gas valves

Carbolite Gero offers vacuum pumps or complete pumping systems with the appropriate vacuum measuring technology.

A vacuum pump package consists of vacuum pump, flowmeter for inert gas, vacuum gauge, vacuum tight valve, bypass for fast purging, gas outlet valve and safety overpressure valve. The appropriate vacuum pump package must be selected to ensure compatibility between the height of the furnace work tube and the vacuum pump. Combining a vacuum pump package with a work tube vacuum package (page 109) offers a complete solution for horizontal tube furnaces. Please contact Carbolite Gero for assistance.

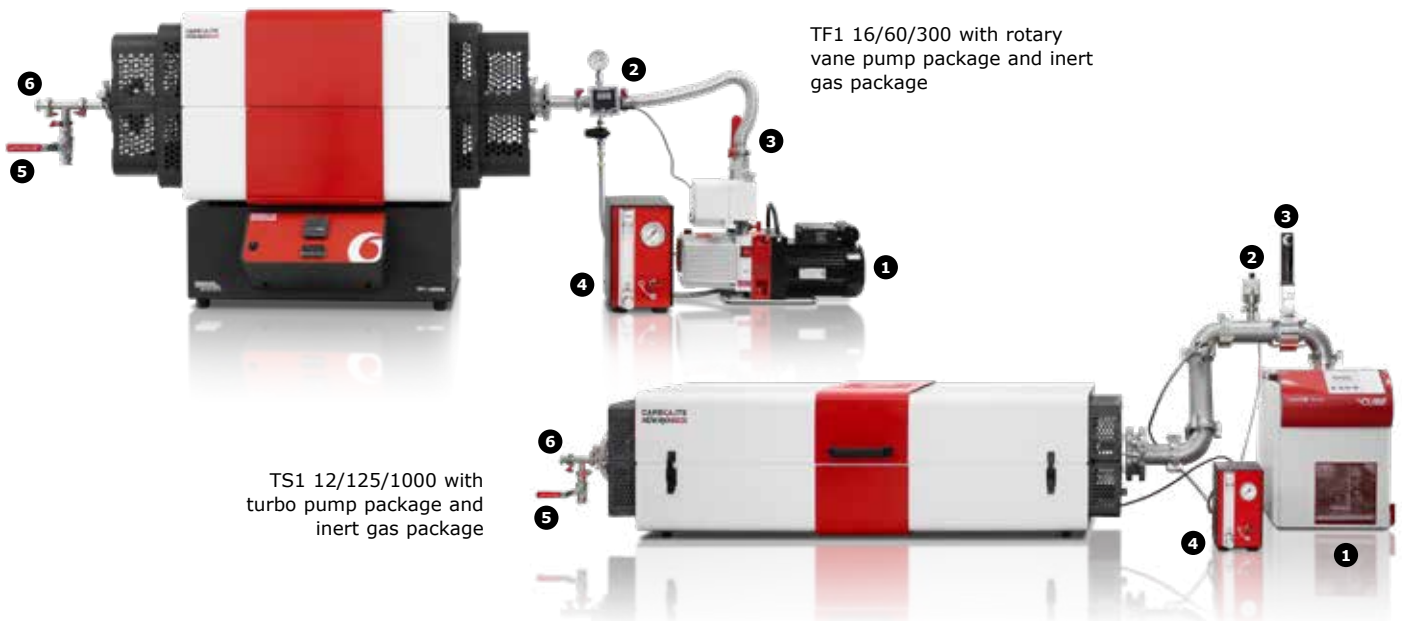

TF1 16/60/300 with rotary vane pump package and inert gas package

TS1 12/125/1000 with turbo pump package and inert gas package

In a cold, clean, dry and empty furnace the rotary vane pump option is able to reach a vacuum level of 5×10^{-2} mbar, the turbo pump option reaches under the same conditions 1×10^{-5} mbars.

The rotary vane pump is a pre vacuum pump and is the most frequently used pump. The pump is used for direct evacuation of atmospheric pressure with a rotating speed of approximately 1,500 turns per minute via a radial, movable plug. The vacuum chamber of the pump is greased with oil.

Standard features

Rotary vane pump package:

- 1) Double stage rotary vane pump with a pumping rate of $4 \text{ m}^3/\text{h}$
- 2) Pirani gauge
- 3) Vacuum tight valve
- 4) Choice of flowmeter and inert gas packages (page 113)
 - Bypass for fast purging
- 5) Gas outlet valve
- 6) Safety overpressure valve

Turbo pump package:

- 1) Turbo pump with a pumping rate of 65 l/s
 - Rotary vane pump as pre pump
- 2) Full range vacuum gauge
- 3) Vacuum tight valve
- 4) Choice of flowmeter and inert gas packages (page 113)
 - Bypass for fast purging
- 5) Gas outlet valve
- 6) Safety overpressure valve

The turbomolecular pump consists of stators between several high speed rotors. The rotational speed is about 90,000 revolutions per minute. At these speeds, the rotor is now in the range of the particle velocity enabling gas to be pushed through the pump. When combined with a pre-vacuum pump, the achievable vacuum level is in the high vacuum range or better. Turbomolecular pumps are the most convenient and frequently used pumps for high and ultra-high vacuum operation. Very high atmospheric purity of the furnace chamber is achieved as the pump easily removes heavy, slow particles, such as hydrocarbons.

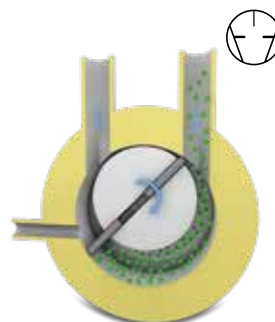

Rotary vane pump

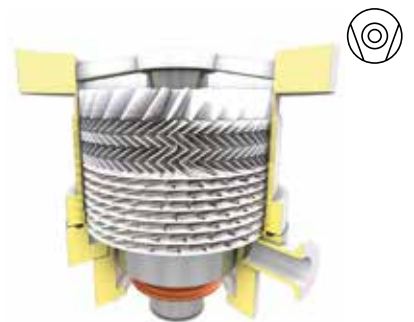

Turbomolecular pump

Inert Gas Packages

These inert gas packages have been designed to work in combination with the gas atmosphere work tube packages to optimise the inert atmosphere inside the work tube. Allowable gases are shown in the table. They are not suitable for flammable gases such as hydrogen or oxygen.

The standard inert gas package includes a manual on/off valve along with pressure gauge and flow meter. The advanced inert gas package has the addition of an electrically operated valve which can be activated by a program segment output or temperature alarm.

The standard inert gas package includes:

- Gas inlet = 6 mm outside diameter push in fitting
- Manual on/off ball valve
- Pressure relief valve
- Pressure gauge
- Flow meter with flow adjustment knob
- Non-return valve
- Fitting and pipe to connect an additional inert gas package
- Gas outlet = 6 mm braided hose with 6 mm union
- Dimensions: H x W x D (mm): 240 x 135 x 215

Gases and flow ranges

Gas	Flow range
Air	1-10 l/min
Nitrogen N ₂	1-10 l/min
Argon Ar	1-8 l/min
95% N ₂ / 5% H ₂	1.2-11 l/min
98% Ar / 2% H ₂	1-9 l/min
Carbon dioxide CO ₂	1-8.5 l/min
Helium He	2-20 l/min

The advanced inert gas package includes:

- Gas inlet = 6 mm outside diameter push in fitting
- Manual on/off ball valve
- Pressure relief valve
- Pressure gauge
- Electrically operated valve
- Flow meter with flow adjustment knob
- Non-return valve
- Fitting and pipe to connect an additional inert gas package
- Gas outlet = 6 mm braided hose with 6 mm union
- Dimensions: H x W x D (mm): 240 x 135 x 215



NOTE: Please select (from the price list) the appropriate advanced inert gas package to specify if the electrically operated valve is activated by either program segment output or temperature alarm.

Multiple gas packages can be used together and have the facility for the user to fix them together to make a combined assembly.

If the temperature controller is an EPC3016P1 or CC-T1 a maximum of two advanced inert gas packages can be combined.

If the temperature controller is an EPC3008P10 or nanodac a maximum of three advanced inert gas packages can be combined.

Laboratory Gas Safety System for Hydrogen from 750 °C to T_{max}

The laboratory gas safety system is required for safe operation when using hydrogen gas in Carbolite Gero tube furnaces or metallic chamber retorts.

The system is suitable for use with either tube furnaces using a suitable work tube package or chamber furnaces using an A105 retort up to a maximum internal volume of 50 litres.

The system is supplied with its own control cabinet, off gas burner and flexible pipes with fittings to connect directly to a gas atmosphere work tube package or chamber A105 retort.

The system automatically purges the work tube or chamber with nitrogen, ensures hydrogen is only introduced to the furnace above a safety temperature of 750 °C, and provides an end purge of nitrogen. A nitrogen purge also occurs in the event of unplanned shutdowns.

Two adjustable flow meters provide the facility for hydrogen and nitrogen flows to be blended to suit the process.

A monitored electrically heated gas ignitor ensures the hydrogen is fully consumed.

Safety features include:

- Over-pressure protection for the work tube or retort
- Excess flow (rupture) protection
- Purge timer
- Independent safety purge
- Supply gas monitoring
- Furnace temperature monitoring
- Electric ignitor



Simplified piping schematic

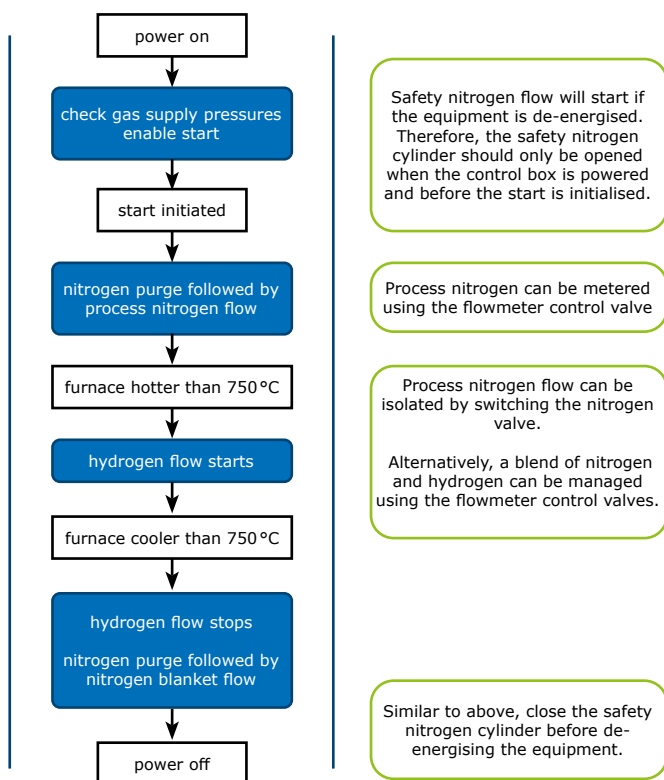
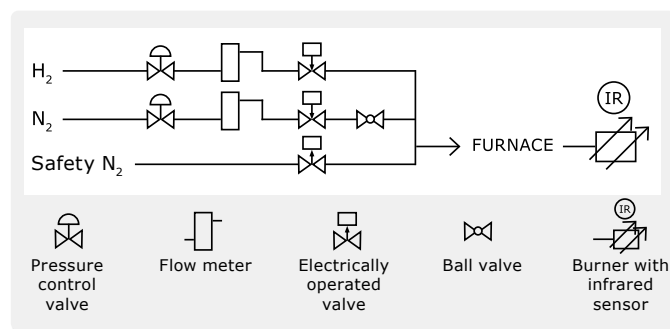

Technical data

Model	Dimensions of control box H x W x D [mm]	Dimensions of burner assembly H x W x D [mm]	Power [W]
LGSS	440 x 430 x 490	650 x 300 x 335	300

The Laboratory Gas Safety System can be used in combination with:

- CWF chamber furnaces
- All FST & FZS tube furnaces with A105 retort
- All HTRH & HTRV tube furnaces
- All TF tube furnaces
- All TS tube furnaces
- All FHA & FHC tube furnaces
- All HTRV-A tube furnaces

Gas Safety System for Hydrogen from RT up to T_{max}

The hydrogen tube furnace system is based on the F-range and HTRH-range. It is designed to meet all required regulations for the safe handling of hydrogen gas. Note: The system is only suited for clean processes. No outgassing of the samples must occur.

Standard features

- Full hydrogen operation for tube furnaces always in combination with a minimum of one inert gas
- Hydrogen from room temperature (RT) up to the maximum temperature
- Safety related SPS with touchpanel control
- Purging tank (N₂)
- Tube materials up to 1100 °C: Quartz
- Tube materials up to 1800 °C: RCA
- Water cooled flanges



HTRH 16/100/600: Hydrogen tube furnace with a heated length of 600 mm up to 1600 °C. Operation under pure hydrogen is possible. All necessary safety provisions are implemented.

Options

- Sample thermocouple
- Second inert gas
- Fine vacuum pump
- Cascade control
- High vacuum pump



A touch panel interface is used for automated operation. All valves, temperatures, gas flows, etc. can be switched on and off manually or automatically by a predetermined program.

- 1) Hydrogen sensor
- 2) Electrical ignitor for hydrogen
- 3) Touchpanel for automatic operation



The purging tank is filled with inert nitrogen at a pressure of 8 bar. The purging tank is a required safety option when working with pure hydrogen or other dangerous gases. In case of an emergency this tank provides enough inert gas for purging the whole furnace multiple times to ensure that no dangerous gas remains in the furnace.

Technical data

Model	T_{max} at atmospheric pressure [°C]	T_{max} in vacuum [°C]	Dimensions: Max. outer Ø accessory tube [mm]	Dimensions: Heated length [mm]	Dimensions: External H x W x D [mm]	Uniform length [mm]	Max. power [kW]	Weight [kg]
SR-H2 11/100/500-2G auto	quartz 1100	quartz 1100	100	500	2050 x 2200 x 1300	200	3	450
HTRH-H2 _/70/300-2G auto	RCA 1600, 1700, 1800	RCA 1450	70	300	2050 x 2200 x 1300	150	9	400
HTRH-H2 _/70/600-2G auto	RCA 1600, 1700, 1800	RCA 1450	70	600	2050 x 2200 x 1300	300	13	450
HTRH-3-H2 _/70/600-2G auto	RCA 1600, 1700, 1800	RCA 1450	70	600	2050 x 2200 x 1300	300	13	450

Carbolite Gero Ovens can be configured by adding a wide range of options which can provide solutions for end users without the need for a special modification. This page shows some of the more universal options available. Please see the lists of options available on each products page.

Inert gas inlet

A 6 mm hose connection is fitted to the product chamber via a tube to create a modified atmosphere. Suitable for the introduction of inert gas. Flow rate may be controlled by flow meters – please see below.

NOTE: The introduction of gases may alter heating characteristics and/or performance characteristics of elements, please contact Carbolite Gero for advice.

Gas flow meters

Used to control the flow rate of a gas into the chamber. A number of flow meters can be fitted for different gases. Suitable for use with argon, carbon dioxide, nitrogen – for other gases please enquire. These are fitted to the product on an additional bracket.



Entry ports

Cable access ports

6 mm, 36 mm, or 48 mm cable port with swivel cover for PN, PF, GP, HT and LHT series ovens. (please state required position when ordering)



Secondary thermocouple

An additional thermocouple is built into the product and connected to a thermocouple socket which is externally mounted on the control panel to enable connection to temperature recorders or other external equipment.

Solenoid valves

Electrically operated valve to control the gas flow into a chamber. Manually activated by a panel mounted switch or automatically using a temperature programmer. A number of solenoid valves can be fitted for different gases; when used with a temperature programmer the gases can be switched on/off in different program segments (requires EPC3016P1, CC-T1, EPC3008P10 or nanodac™ controller).

Other options (available for most products include)

- Access port for independent thermocouple
- Accessory shelves & runners
- Viewing window
- Interior light
- Lockable door
- Door interlock activated by temperature alarm relay
- Door switch to isolate elements
- Floor stands & wheeled trolleys



Carbolite Gero Chamber Furnaces can be configured by adding a wide range of options which can provide solutions for end users without the need for a special modification. This page shows some of the more universal options available. Please see the lists of options available on each products page.

Inert gas inlet

A 6 mm hose connection is fitted to the product chamber via a tube to create a modified atmosphere. Suitable for the introduction of inert gas. Flow rate may be controlled by flow meters – please see below.

NOTE: The introduction of gases may alter heating characteristics and/or performance characteristics of furnace elements, please contact Carbolite Gero for advice.

Gas flow meters

Used to control the flow rate of a gas into the chamber or retort. A number of flow meters can be fitted for different gases. Suitable for use with argon, carbon dioxide, nitrogen – for other gases please enquire. These are fitted to the product on an additional bracket.



Solenoid valves

Electrically operated valve to control the gas flow into a chamber or retort. Manually activated by a panel mounted switch or automatically using a temperature programmer. A number of solenoid valves can be fitted for different gases; when used with a temperature programmer the gases can be switched on/off in different program segments (requires EPC3016P1, CC-T1, EPC3008P10 or nanodac™ controller).



Entry ports

Access and viewing ports

A 25 mm diameter hole is positioned in the furnace door and is either fitted with a pivoted stainless steel cover or a permanent quartz window.



Thermocouple calibration port

An additional ceramic thermocouple sheath is installed adjacent to the control thermocouple. This allows the user to insert a reference thermocouple for checking and calibration of the furnace's controller / thermocouple. This is normally located in the rear of the chamber.

CARBOLITE GERO not only offers a wide selection of high temperature furnaces but also high-quality accessories and consumables for effective and safe heat treatment applications.

Personal Safety Equipment

Item Number	Item Description
	Face protection with green shield made of acetate
	Face protection with clear shield
	3-finger gloves up to 1000°C, outer surface aluminated, 1 pair
	Kevlar gloves up to 350°C, 1 pair
	Crucible tongs stainless steel, 304 stainless steel, total length: 400mm, handle length: 175mm, tong thickness: 8mm

Quartz Glass Crucibles

Item Number	Item Description	Outer Diameter [mm]	Height [mm]	Volume [ml]
	Quartz Glass Crucible	40	25	15
	Quartz Glass Crucible	50	32	29
	Quartz Glass Crucible	70	44	85
	Quartz Glass Crucible	30	38	15
	Quartz Glass Crucible	40	50	40
	Quartz Glass Crucible	50	62	75

Quartz Glass Boats

Item Number	Item Description	Length [mm]	Width [mm]	Height [mm]	ID Work tube ¹⁾ [mm]
	Quartz glass boat	40	13	6	30
	Quartz glass boat	60	20	8	30
	Quartz glass boat	80	32	14	50
	Quartz glass boat	100	40	18	60
	Quartz glass boat	120	70	32	90
	Quartz glass boat	150	80	36	110
	Quartz glass boat	200	42	19	60
	Quartz glass boat	300	85	40	110



Face protection



3-finger gloves



Kevlar gloves



Crucible tongs



Quartz Glass Crucible



Quartz Glass Boat



RCA Crucibles (cylindrical)



RCA Plates

RCA Crucibles (cylindrical)

Item Number	Item Description	Outer Diameter [mm]	Inner Diameter [mm]	Height [mm]	Volume [ml]
	RCA Crucible (Cylinder)	20	16	30	6
	RCA Crucible (Cylinder)	30	26	40	20
	RCA Crucible (Cylinder)	40	36	60	60
	RCA Crucible (Cylinder)	50	44	75	110
	RCA Crucible (Cylinder)	65	55	100	225
	RCA Crucible (Cylinder)	85	73	150	600
	RCA Crucible (Cylinder)	110	100	150	1100

RCA Boats

Item Number	Item Description	Length [mm]	Width [mm]	Height [mm]	Wall thickness [mm]	Volume [ml]	ID Work tube ¹⁾ [mm]
	RCA boat 799	32	9	6	2	0,2	20
	RCA boat 799	48	9	6	2	0,4	20
	RCA boat 799	69	9	6	2	0,7	20
	RCA boat 799	50	15	8	2,5	1,7	30
	RCA boat 799	87	15	8	2,5	2,8	30
	RCA boat 799	112	15	8	2,5	4,7	30
	RCA boat 799	92	18	10	3	5,5	35
	RCA boat 799	118	18	10	3	7	35
	RCA boat 799	58	23	13	3	5,2	45
	RCA boat 799	92	23	13	3	9,5	45
	RCA boat 799	124	23	13	3	13,5	45
	RCA boat 799	102	31	17	3	20	55
	RCA boat 799	130	31	17	3	27	55

RCA Boxes

Item Number	Item Description	Length [mm]	Width [mm]	Height [mm]	Wall thickness [mm]	Volume [ml]
	RCA box 799	50	25	20	3	12
	RCA box 799	50	50	20	3	26
	RCA box 799	75	50	20	4	35
	RCA box 799	100	50	30	4	95

RCA Plates

Item Number	Item Description	Dimensions (W x L x H) [mm]
	Ceramic plate RCA 799	53 x 53 x 6
	Ceramic plate RCA 799	230 x 200 x 6

¹⁾ Recommended Minimum Inner Diameter Work tube

The table below shows the standard power supply for products requiring an electrical supply more than 16 A single phase. Products not listed here can be used on a 220-204V single phase 16 A supply. Other voltages on request. Please mention your preferred voltage in your enquiry. Upgrade prices may apply.

	Model	Volt	Phase	Ampere per phase
CGH	AAF /18 litre	220-240	single phase	30
CGH	AAF /18 litre	220-240	3 phase delta	18.5
CGH	AAF /18 litre	380-415	3 phase + N	10.5
CGH	AAF 11/7	240	single phase	17
CGH	AAF 11/7	220-230	single phase	16
CGH	AAF 11/7	380-415	2 phase + N	8.2
CGH	AAF /32 litre	220-240	single phase	44
CGH	AAF /32 litre	220-240	3 phase delta	26
CGH	AAF /32 litre	380-415	3 phase + N	15
CGH	AAF-BAL /17	220-240	single phase	30
CGH	AAF-BAL /17	220-240	3 phase delta	18.5
CGH	AAF-BAL /17	380-415	3 phase + N	10.5
CGH	ABA 7/35	220-240	single phase	40
CGH	ABA 7/35	220-240	3 phase delta	24
CGH	ABA 7/35	380-415	3 phase + N	15
CGH	ABF 8/28	220-240	single phase	40
CGH	ABF 8/28	220-240	3 phase delta	24
CGH	ABF 8/28	380-415	3 phase + N	15
CGH	BLF __/21	380-415	3 phase + N	20
CGH	BLF 16/3	380-415	3 phase + N	16
CGH	BLF 16/3	220-240	single phase	48
CGH	BLF 17/3	200-208	single phase	29
CGH	BLF 17/3	220-240	single phase	28
CGH	BLF 17/3	380-415	2 phase + N	16.5
CGH	BLF 17/8	208	single phase	49
CGH	BLF 17/8	208	3 phase delta	29
CGH	BLF 17/8	220-240	single phase	46
CGH	BLF 17/8	220-240	3 phase delta	27
CGH	BLF 17/8	380-415	3 phase + N	15.5
CGH	BLF 18/3	208	single phase	26
CGH	BLF 18/3	220-240	single phase	25
CGH	BLF 18/8	208	3 phase delta	29
CGH	BLF 18/8	220-240	3 phase delta	27
CGH	BLF 18/8	380-415	3 phase + N	15.5
CGH	CAF G5	220-240	single phase	49
CGH	CAF G5	380-415	2 phase + N	25
CGH	CDHT	380-415	3 phase + N	13
CGH	CDLT	380-415	3 phase + N	6.8
CGH	CF 24	200	single phase	87
CGH	CF 24	440	3 phase no N	30
CGH	CF 24	200-240	3 phase delta	50
CGH	CF 24	380-415	3 phase + N	28
CGH	CF 60	440	3 phase + N	59
CGH	CF 60	200-240	3 phase delta	103
CGH	CF 60	380-415	3 phase + N	59
CGH	CF15	200-240	single phase	68
CGH	CF15	200-240	3 phase delta	40
CGH	CF15	380-415	3 phase + N	23
CGH	CR /330 litre	220-240	single phase	19.5
CGH	CR /330 litre	380-415	3 phase + N	8.9
CGH	CR /450 litre	220-240	3 phase delta	15.5
CGH	CR /450 litre	380-415	3 phase + N	8.9
CGH	CR above 450 please enquire			

	Model	Volt	Phase	Ampere per phase
CGH	CWF /13 litre	220-240	single phase	13
CGH	CWF /13 litre	380-415	2 phase + N	7.1
CGH	CWF /23 litre	110-120	single phase	60
CGH	CWF /23 litre	200-208	single phase	36
CGH	CWF /23 litre	200-208	3 phase delta	22
CGH	CWF /23 litre	220-240	single phase	30
CGH	CWF /23 litre	220-240	3 phase delta	18.5
CGH	CWF /23 litre	380-415	3 phase + N	10.5
CGH	CWF /23 litre	380-415	3 phase no N	11
CGH	CWF /23 litre	440-480	3 phase no N	10.5
CGH	CWF /36 litre	220-240	single phase	44
CGH	CWF /36 litre	220-240	3 phase delta	26
CGH	CWF /36 litre	380-415	3 phase + N	15
CGH	CWF /65 litre	220-240	single phase	63
CGH	CWF /65 litre	220-240	3 phase delta	37
CGH	CWF /65 litre	380-415	3 phase + N	21
CGH	CWF-B /13 litre	220-240	single phase	13
CGH	CWF-B /13 litre	380-415	2 phase + N	7.1
CGH	CWF-BAL /21	220-240	single phase	30
CGH	CWF-BAL /21	220-240	3 phase delta	18.5
CGH	CWF-BAL /21	380-415	3 phase + N	10.5
CGH	ELF 11/23	200-240	single phase	25
CGH	ELF 11/23	380-415	2 phase + N	12.5
CGN	FHA 13/50/750	380-415	3 phase + N	max. 16A
CGN	FHA 13/50/750		other voltages and phases on request	
CGN	FHA 13/80/500	380-415	3 phase + N	max. 16A
CGN	FHA 13/80/500		other voltages and phases on request	
CGN	FHA 13/80/750	380-415	3 phase + N	max. 32A
CGN	FHA 13/80/750		other voltages and phases on request	
CGN	FHA 13/80/1000	380-415	3 phase + N	max. 32A
CGN	FHA 13/80/1000		other voltages and phases on request	
CGN	FHA 13/110/500	380-415	3 phase + N	max. 32A
CGN	FHA 13/110/500		other voltages and phases on request	
CGN	FHA 13/110/750	380-415	3 phase + N	max. 32A
CGN	FHA 13/110/750		other voltages and phases on request	
CGN	FHA 13/110/1000	380-415	3 phase + N	max. 63A
CGN	FHA 13/110/1000		other voltages and phases on request	
CGN	FHA 13/110/1250	380-415	3 phase + N	max. 63A
CGN	FHA 13/110/1250		other voltages and phases on request	
CGN	FHC 13/50/750	380-415	3 phase + N	max. 16A
CGN	FHC 13/50/750		other voltages and phases on request	
CGN	FHC 13/80/500	380-415	3 phase + N	max. 16A
CGN	FHC 13/80/500		other voltages and phases on request	
CGN	FHC 13/80/750	380-415	3 phase + N	max. 32A
CGN	FHC 13/80/750		other voltages and phases on request	
CGN	FHC 13/80/1000	380-415	3 phase + N	max. 32A
CGN	FHC 13/80/1000		other voltages and phases on request	
CGN	FHC 13/110/500	380-415	3 phase + N	max. 32A
CGN	FHC 13/110/500		other voltages and phases on request	
CGN	FHC 13/110/750	380-415	3 phase + N	max. 32A
CGN	FHC 13/110/750		other voltages and phases on request	
CGN	FHC 13/110/1000	380-415	3 phase + N	max. 63A
CGN	FHC 13/110/1000		other voltages and phases on request	

	Model	Volt	Phase	Ampere per phase
CGN	FHC 13/110/1250	380-415	3 phase + N	max. 63A
CGN	FHC 13/110/1250	other voltages and phases on request		
CGN	FST 13/100/500	380-415	3 phase + N	max. 16A
CGN	FST 13/100/500	other voltages and phases on request		
CGN	FST 13/100/1000	380-415	3 phase + N	max. 32A
CGN	FST 13/100/1000	other voltages and phases on request		
CGN	FST 13/150/1000	380-415	3 phase + N	max. 63A
CGN	FST 13/150/1000	other voltages and phases on request		
CGN	FZS 13/100/500	380-415	3 phase + N	max. 16A
CGN	FZS 13/100/500	other voltages and phases on request		
CGN	FZS 13/100/1000	380-415	3 phase + N	max. 32A
CGN	FZS 13/100/1000	other voltages and phases on request		
CGN	FZS 13/150/1000	380-415	3 phase + N	max. 63A
CGN	FZS 13/150/1000	other voltages and phases on request		
CGN	FZS 13/150/1000	other voltages and phases on request		
CGN	GLO models	please enquire		
CGH	GP330	220-240	single phase	19.5
CGH	GP330	220-240	3 phase delta	12
CGH	GP330	380-415	3 phase + N	7
CGH	GP450	220-240	single phase	26
CGH	GP450	220-240	3 phase delta	15
CGH	GP450	380-415	3 phase + N	12.5
CGH	GPC __/131B	200-240	3 phase delta	80
CGH	GPC __/131B	380-415	3 phase + N	50
CGH	GPC __/200B	other voltages and phases on request		
CGH	GPC __/200B	380-415	3 phase + N	50
CGH	GPC __/300B	200-240	3 phase delta	125
CGH	GPC __/300B	380-415	3 phase + N	63
CGH	GPC __/350B	200-240	3 phase delta	125
CGH	GPC __/350B	380-415	3 phase + N	80
CGH	GPCMA/ __ please enquire			
CGN	HB	please enquire		
CGH	HRF 7/112	220-240	3 phase delta	44
CGH	HRF 7/112	380-415	3 phase + N	26
CGH	HRF 7/324	380-415	3 phase + N	34
CGH	HRF 7/45	220-240	single phase	26
CGH	HRF 7/45	220-240	3 phase delta	15.5
CGH	HRF 7/45	380-415	3 phase + N	9
CGH	HT, HTCR, HTMA 5/220	220-240	single phase	19.5
CGH	HT, HTCR, HTMA 5/220	380-415	2 phase + N	10
CGH	HT, HTCR, HTMA 6/220	220-240	single phase	26
CGH	HT, HTCR, HTMA 6/220	220-240	3 phase delta	15
CGH	HT, HTCR, HTMA 6/220	380-415	3 phase + N	12.5
CGH	HT, HTCR, HTMA 6/95	220-240	single phase	19.5
CGH	HT, HTCR, HTMA 6/95	380-415	2 phase + N	10
CGH	HTMA 7/95	380-415	3 phase + N	25
CGH	HT, HTCR, HTMA above 220 litre please enquire			
CGH	HTF 17/10	220-240	single phase	28
CGH	HTF 17/10	380-415	2 phase + N	16
CGH	HTF 17/27	380-415	3 phase + N	max. 32A
CGH	HTF 17/27	other voltages on request		
CGH	HTF 18/27	380-415	3 phase + N	max. 32A
CGH	HTF 18/27	other voltages on request		
CGH	HTF 18/4	220-240	single phase	21

	Model	Volt	Phase	Ampere per phase
CGH	HTF 18/4	380-415	2 phase + N	16
CGH	HTF 18/8	220-240	single phase	30
CGH	HTF 18/8	380-415	2 phase + N	16
CGN	HTF __/64	380-415	3 phase + N	max. 63A
CGN	HTF __/64	other voltages and phases on request		
CGN	HTF __/128	380-415	3 phase + N	max. 125A
CGN	HTF __/128	other voltages and phases on request		
CGN	HTF __/165 - please enquire			
CGN	HTF __/250 - please enquire			
CGN	HTF __/332 - please enquire			
CGN	HTF __/514 - please enquire			
CGN	HTRH __/40/500	380-415	3 phase + N	max. 32A
CGN	HTRH __/40/500	other voltages and phases on request		
CGN	HTRH __/70/150	380-415	3 phase + N	max. 16A
CGN	HTRH __/70/150	other voltages and phases on request		
CGN	HTRH __/70/300	380-415	3 phase + N	max. 16A
CGN	HTRH __/70/300	other voltages and phases on request		
CGN	HTRH __/70/600	380-415	3 phase + N	max. 32A
CGN	HTRH __/70/600	other voltages and phases on request		
CGN	HTRH __/100/150	380-415	3 phase + N	max. 16A
CGN	HTRH __/100/150	other voltages and phases on request		
CGN	HTRH __/100/300	380-415	3 phase + N	max. 32A
CGN	HTRH __/100/300	other voltages and phases on request		
CGN	HTRH __/100/600	380-415	3 phase + N	max. 32A
CGN	HTRH __/100/600	other voltages and phases on request		
CGN	HTRH __/150/300	380-415	3 phase + N	max. 32A
CGN	HTRH __/150/300	other voltages and phases on request		
CGN	HTRH __/150/600	380-415	3 phase + N	max. 32A
CGN	HTRH __/150/600	other voltages and phases on request		
CGN	HTRH __/200/300	380-415	3 phase + N	max. 32A
CGN	HTRH __/200/300	other voltages and phases on request		
CGN	HTRH __/200/600	380-415	3 phase + N	max. 32A
CGN	HTRH __/200/600	other voltages and phases on request		
CGN	HTRH-3 __/70/600	380-415	3 phase + N	max. 32A
CGN	HTRH-3 __/70/600	other voltages and phases on request		
CGN	HTRH-3 __/100/600	380-415	3 phase + N	max. 32A
CGN	HTRH-3 __/100/600	other voltages and phases on request		
CGN	HTRH-3 __/150/600	380-415	3 phase + N	max. 32A
CGN	HTRH-3 __/150/600	other voltages and phases on request		
CGN	HTRV __/40/500	380-415	3 phase + N	max. 16A
CGN	HTRV __/40/500	other voltages and phases on request		
CGN	HTRV __/70/250	380-415	3 phase + N	max. 16A
CGN	HTRV __/70/250	other voltages and phases on request		
CGN	HTRV __/70/500	380-415	3 phase + N	max. 32A
CGN	HTRV __/70/500	other voltages and phases on request		
CGN	HTRV __/100/250	380-415	3 phase + N	max. 16A
CGN	HTRV __/100/250	other voltages and phases on request		
CGN	HTRV __/100/500	380-415	3 phase + N	max. 32A
CGN	HTRV __/100/500	other voltages and phases on request		
CGN	HTRV __/150/250	380-415	3 phase + N	max. 32A
CGN	HTRV __/150/250	other voltages and phases on request		
CGN	HTRV __/150/500	380-415	3 phase + N	max. 63A
CGN	HTRV __/150/500	other voltages and phases on request		

	Model	Volt	Phase	Ampere per phase
CGN	HTRV __/200/250	380-415	3 phase + N	max. 32A
CGN	HTRV __/200/250	other voltages and phases on request		
CGN	HTRV __/200/500	380-415	3 phase + N	max. 63A
CGN	HTRV __/200/500	other voltages and phases on request		
CGN	HTRV-A __/70/120	380-415	3 phase + N	max. 16A
CGN	HTRV-A __/70/120	other voltages and phases on request		
CGN	HTRV-A __/70/250	380-415	3 phase + N	max. 32A
CGN	HTRV-A __/70/250	other voltages and phases on request		
CGN	HTRV-A __/70/500	380-415	3 phase + N	max. 32A
CGN	HTRV-A __/70/500	other voltages and phases on request		
CGH	LCF – please enquire			
CGH	LGP – please enquire			
CGH	RHF 14/15	200-240	3 phase delta	38
CGH	RHF 14/15	380-415	3 phase + N	22
CGH	RHF 14/3	200-240	single phase	22
CGH	RHF 14/3	380-415	2 phase + N	15
CGH	RHF 14/35	200-240	3 phase delta	60
CGH	RHF 14/35	380-415	3 phase + N	35
CGH	RHF 14/35	440-480	3 phase no N	35
CGH	RHF 14/8	200-240	single phase	50
CGH	RHF 14/8	380-415	2 phase + N	25
CGH	RHF 15/15	200-240	3 phase delta	43
CGH	RHF 15/15	380-415	3 phase + N	25
CGH	RHF 15/3	200-240	single phase	36
CGH	RHF 15/3	380-415	2 phase + N	18
CGH	RHF 15/35	200-240	3 phase delta	60
CGH	RHF 15/35	380-415	3 phase + N	35
CGH	RHF 15/35	380-415	3 phase no N	35
CGH	RHF 15/35	440-480	3 phase no N	35
CGH	RHF 15/8	200-208	3 phase delta	38
CGH	RHF 15/8	200-240	3 phase delta	30
CGH	RHF 15/8	380-415	3 phase + N	17.5
CGH	RHF 15/8	380-415	3 phase no N	17.5
CGH	RHF 16/15	200-240	3 phase delta	42
CGH	RHF 16/15	380-415	3 phase + N	25
CGH	RHF 16/15	440-480	3 phase + N	25
CGH	RHF 16/3	200-240	single phase	36
CGH	RHF 16/3	200-240	3 phase delta	30
CGH	RHF 16/3	380-415	2 phase + N	18
CGH	RHF 16/35	200-240	3 phase delta	62
CGH	RHF 16/35	380-415	3 phase + N	40
CGH	RHF 16/35	380-415	3 phase no N	37
CGH	RHF 16/35	440-480	3 phase + N	40
CGH	RHF 16/8	200-208	3 phase delta	34
CGH	RHF 16/8	200-208	single phase	59
CGH	RHF 16/8	220-240	single phase	50
CGH	RHF 16/8	220-240	3 phase delta	29
CGH	RHF 16/8	380-415	3 phase + N	18
CGH	RHF 16/8	380-415	3 phase no N	18
CGH	RHF 16/8	440-480	3 phase + N	18
CGH	RWF /13 litre	220-240	single phase	22
CGH	RWF /13 litre	380-415	2 phase + N	11
CGH	RWF /23 litre	220-240	single phase	39

	Model	Volt	Phase	Ampere per phase
CGH	RWF /23 litre	220-240	3 phase delta	23
CGH	RWF /23 litre	380-415	3 phase + N	13
CGH	SCF – please enquire			
CGH	TF1 12/125/1000	220-240	1 phase + N	20
CGH	TF1 12/125/1000	200-240	3 phase delta	16
CGH	TF1 12/125/1000	380-415	3 phase + N	10
CGH	TF1 12/125/1200	220-240	1 phase + N	25
CGH	TF1 12/125/1200	200-240	3 phase delta	16
CGH	TF1 12/125/1200	380-415	3 phase + N	16
CGH	TF3 12/125/1000	220-240	1 phase + N	20
CGH	TF3 12/125/1000	200-240	3 phase delta	16
CGH	TF3 12/125/1000	380-415	3 phase + N	10
CGH	TF3 12/125/1200	220-240	1 phase + N	25
CGH	TF3 12/125/1200	200-240	3 phase delta	16
CGH	TF3 12/125/1200	380-415	3 phase + N	16
CGH	TF1 16/60/180	110-120	1 phase + N	32
CGH	TF1 16/60/180	220-240	1 phase + N	16
CGH	TF1 16/60/300	220-240	1 phase + N	25
CGH	TF1 16/100/450	220-240	1 phase + N	40
CGH	TF1 16/100/450	200-240	3 phase delta	25
CGH	TF1 16/100/450	380-415	3 phase + N	16
CGH	TF1 16/100/600	220-240	1 phase + N	50
CGH	TF1 16/100/600	200-240	3 phase delta	25
CGH	TF1 16/100/600	380-415	3 phase + N	16
CGH	TF3 16/100/450	220-240	1 phase + N	50
CGH	TF3 16/100/450	200-240	3 phase delta	32
CGH	TF3 16/100/450	380-415	3 phase + N	25
CGH	TF3 16/100/600	220-240	1 phase + N	50
CGH	TF3 16/100/600	200-240	3 phase delta	40
CGH	TF3 16/100/600	380-415	3 phase + N	32
CGH	TS1 12/125/1000	220-240	1 phase + N	20
CGH	TS1 12/125/1000	200-240	3 phase delta	16
CGH	TS1 12/125/1000	380-415	3 phase + N	10
CGH	TS1 12/125/1200	220-240	1 phase + N	25
CGH	TS1 12/125/1200	200-240	3 phase delta	16
CGH	TS1 12/125/1200	380-415	3 phase + N	16
CGH	TS3 12/125/1000	220-240	1 phase + N	20
CGH	TS3 12/125/1000	200-240	3 phase delta	16
CGH	TS3 12/125/1000	380-415	3 phase + N	10
CGH	TS3 12/125/1200	220-240	1 phase + N	25
CGH	TS3 12/125/1200	200-240	3 phase delta	16
CGH	TS3 12/125/1200	380-415	3 phase + N	16
CGH	TS1 12/200/600	220-240	1 phase + N	40
CGH	TS1 12/200/600	200-240	3 phase delta	25
CGH	TS1 12/200/600	380-415	3 phase + N	16
CGH	TS1 12/200/1200	200-240	3 phase delta	40
CGH	TS1 12/200/1200	380-415	3 phase + N	25
CGH	TS3 12/200/600	220-240	1 phase + N	40
CGH	TS3 12/200/600	200-240	3 phase delta	25
CGH	TS3 12/200/600	380-415	3 phase + N	16
CGH	TS3 12/200/1200	200-240	3 phase delta	40
CGH	TS3 12/200/1200	380-415	3 phase + N	25
CGH	TSO1 11/1000	220-240	1 phase + N	20

	Model	Volt	Phase	Ampere per phase
CGH	TSO1 11/1000	220-240	3 phase delta	16
CGH	TSO1 11/1000	380-415	3 phase + N	10
CGH	TSO3 11/1000	220-240	1 phase + N	20
CGH	TSO3 11/1000	220-240	3 phase delta	16
CGH	TSO3 11/1000	380-415	3 phase + N	10
CGH	TSR1 12/125/1000	220-240	1 phase + N	20
CGH	TSR1 12/125/1000	220-240	3 phase delta	16
CGH	TSR1 12/125/1000	380-415	3 phase + N	10
CGH	TSR3 12/125/1000	220-240	1 phase + N	20
CGH	TSR3 12/125/1000	220-240	3 phase delta	16
CGH	TSR3 12/125/1000	380-415	3 phase + N	10
CGH	VCF 12/100	220-240	single phase	69
CGH	VCF 12/100	220-240	3 phase delta	40
CGH	VCF 12/100	380-415	3 phase + N	23
CGH	VCF 12/23	220-240	single phase	25
CGH	VCF 12/23	380-415	3 phase + N	11.5

Model	Description	up to	Page
A			
AAF	Standard Ashing Furnaces	1200°C	53
AAF-BAL	Ashing Furnace with Balance	1100°C	55
ABA	Asphalt Binder Analyser	750°C	58
ABF	Afterburner Ashing Furnaces	800°C	57
AX	Laboratory Bench Mounted Ovens	250°C	13
AZ	8-Zone Tube Furnaces	1350°C	95
B			
BLF	High Temperature Bottom Loading Furnaces	1800°C	38
C			
CAF G5	Coal Ash Fusibility Furnace	1600°C	92
CF	Cupellation Furnaces	1200°C	94
CR	Clean Room Ovens	250°C	23
CRF/1	Carbon Anode Reactivity Test Furnace	1000°C	93
CWF	Standard Chamber Furnaces	1300°C	30
CWF-B	Burn-off Chamber Furnaces	1200°C	30
CWF-BAL	Chamber Furnaces with Balance	1100°C	30
E			
ELF	Economy Chamber Furnaces	1100°C	29
F			
FHA	Horizontal and Vertical Tube Furnaces	1350°C	74
FHC	3-Zone Horizontal and Vertical Tube Furnaces	1350°C	74
FST	Horizontal and Vertical Split Tube Furnaces	1300°C	76
FZS	3-Zone Horizontal and Vertical Split Tube Furnaces	1300°C	76
G			
GLO	Annealing Furnaces	1100°C	46
GP	General Purpose Ovens	300°C	17
GPC	General Purpose Chamber Furnaces	1300°C	42
GPCMA	Modified Atmosphere Chamber Furnaces	1150°C	44
GSM	Specialist Ashing Furnaces	1100°C	56
H			
HB	Top Hat Furnaces	1800°C	48
HRF	Air Recirculating Furnaces	750°C	33
HT	High Temperature Industrial Ovens	700°C	19
HTCR	High Temperature Clean Room Ovens	600°C	24

Model	Description	up to	Page
HTF	High Temperature Laboratory Chamber Furnaces	1800°C	39
HTF	High Temperature Industrial Chamber Furnaces	1800°C	40
HTMA	High Temperature Modified Atmosphere Ovens	700°C	22
HTRH	High Temperature Horizontal Tube Furnaces	1800°C	80
HTRH-3	3-Zone High Temperature Horizontal Tube Furnaces	1800°C	80
HTRV	High Temperature Vertical Tube Furnaces	1800°C	82
HTRV-A	High Temperature Vertical Split Tube Furnaces	1700°C	84
I			
IOR	Iron Ore Reducibility Test Furnace	1100°C	93
L			
LCF	Large Chamber Furnaces	1400°C	50
LGP	Large General Purpose Ovens	700°C	20
LHT	High Temperature Bench Mounted Ovens	600°C	16
M			
MTT	Carbon-14 and Tritium Furnaces	1200°C	95
P			
PF	Fan Convection Ovens	300°C	15
PN	Natural Convection Ovens	300°C	14
PTC	Thermocouple Calibration Furnaces	1200°C	93
R			
RHF	High Temperature Chamber Furnaces	1600°C	36
RWF	Rapid Heating Chamber Furnaces	1200°C	34
S			
SBCF	Static or Bogie Hearth Chamber Furnaces	1100°C	51
T			
TF	Universal Tube Furnace	1200°C	66
TF	Universal Tube Furnace	1600°C	78
TG	Gradient Tube Furnaces	1200°C	86
TLD	Rapid Cooling Ovens	400°C	18
TS	Split Tube Furnaces	1200°C	70
TSO	Rotary Reactor Tube Furnaces	1100°C	90
TSR	Rotating Horizontal Split Tube Furnaces	1150°C	89
V			
VCF	Top Loading Chamber Furnaces	1200°C	35

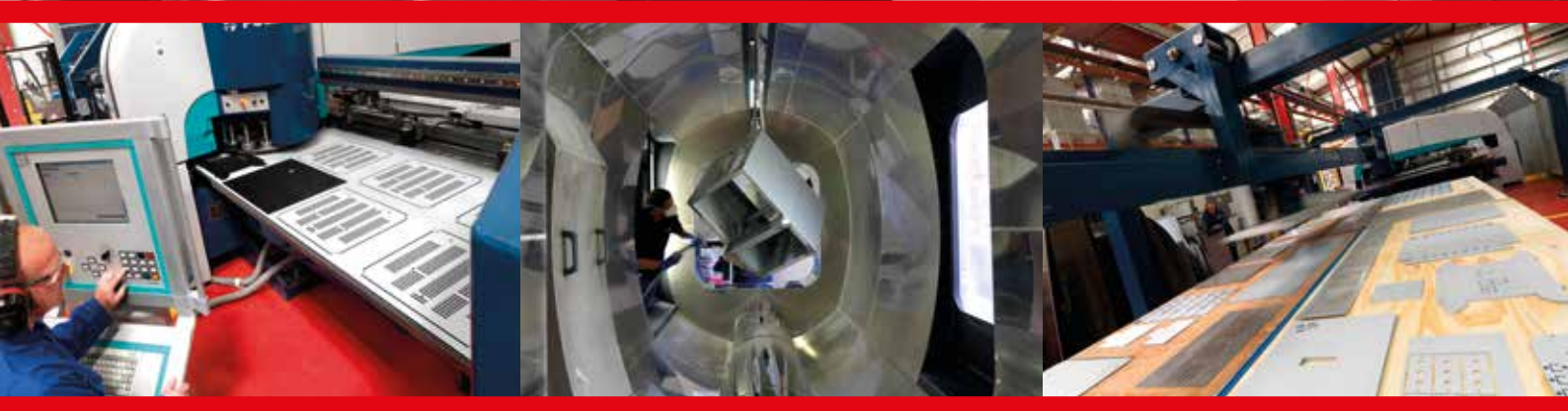

Sign up for our newsletter!

You will occasionally receive **exclusive information** on seminars/webinars, applications and product news.

Subscribe now:



www.carbolite-gero.com/newsletter
(You may unsubscribe any time)

