

**1. Part Number:** A126-05

**2. Photograph:**

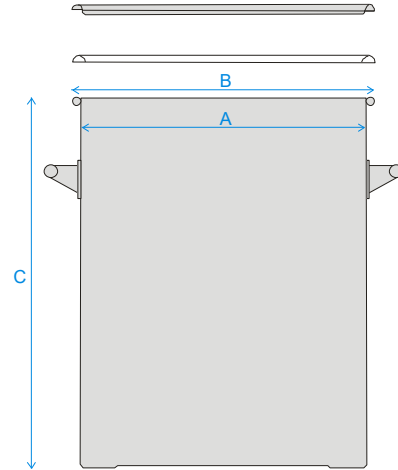

### 3. Product Information:

Description	Stainless Storage Drum 5L
Materials of Construction:	<ul style="list-style-type: none"> <li>- Body: 316L stainless steel</li> <li>- Lid: 316L stainless steel</li> <li>- Clamp: 304 stainless steel</li> <li>- Handles: 304 stainless steel</li> <li>- Gasket: Silicone (FDA 177.2600 compliant &amp; BSE/TSE free)</li> </ul>
Nominal Volume:	5 Litres
Brimful Volume:	6 Litres
Method of Construction:	Welds ground and polished
Surface Finish:	Better than 0.5 microns Ra
Dimensions	A = 196 mm B = 216 mm C = 200 mm
Drum Wall Thickness:	1.2mm
Graduation Marks:	None
Handles:	2 side handles welded onto patch plates
Weight:	2.7 Kg (body + gasket + lid + clamp)
BSE/TSE statement:	All polishing compounds used in the manufacture of this product are of vegetable origin.
Recommended Storage Conditions:	Dry and ambient temperature

### 4. Approval:

Signed:



Name: Kuldeep Flora

Position: Quality Manager

Date: 14-Aug-20



**Sampling Systems Ltd.**

4-5 Forge Mills Park, Coleshill, Warwickshire, B46 1JH, UK.  
 Tel: +44(0)1675 466992 Email: info@sampling.com Web: www.sampling.com